

MONOLINGUAL

Oxford
American
English

The New Oxford Picture Dictionary



E.C. PARNWELL

Property of the SCASD
COMMUNITY EDUCATION

12

Monolingual English Edition

The New Oxford Picture Dictionary

E. C. Parnwell

Illustrations by:

Ray Burns

Bob Giuliani

Laura Hartman

Pamela Johnson

Melodye Rosales

Raymond Skibinski

Joel Snyder

Oxford University Press

Oxford University Press
200 Madison Avenue
New York, NY 10016 USA
Walton Street
Oxford OX2 6DP England

OXFORD is a trademark of Oxford University Press.

Library of Congress Cataloging-in-Publication Data

Parnwell, E. C.

The new Oxford picture dictionary.

Rev. ed. of: Oxford picture dictionary of American English.

1. Picture dictionaries, English. 2. English language—United States—Dictionaries. 3. Americanisms—Dictionaries. 4. English language—Text-books for foreign speakers. I. Parnwell, E.C. Oxford picture dictionary of American English. II. Title.

PE2835.P37 423'.1 87-23950

ISBN 0-19-434199-2 (softcover)

ISBN 0-19-434533-5 (hardcover)

Copyright © 1988 Oxford University Press

All rights reserved. No part of this publication may be reproduced, stored in a retrieval system, or transmitted, in any form or by any means, electronic, mechanical, photocopying, recording, or otherwise, without the prior permission of Oxford University Press.

This book is sold subject to the condition that it shall not, by way of trade or otherwise, be lent, resold, hired out, or otherwise circulated without the publisher's prior consent in any form of binding or cover other than that in which it is published and without a similar condition including this condition being imposed on the subsequent purchaser.

Developmental Editor: Margot Gramer
Consulting Editor: Joan Saslow
Pronunciation Editor: Clifford Hill, Columbia University
Associate Editor: Mary Lynne Nielsen
Editorial Assistant: Jeanne Rabenda
Art Director: Shireen Nathoo

The publisher would like to thank the following agents for their cooperation:

Carol Bancroft and Friends, representing Bob Giuliani, Laura Hartman, and Melodye Rosales.

Publishers Graphics Inc., representing Ray Burns, Pamela Johnson, and Joel Snyder.

Cover illustration by Laura Hartman.

Softcover Printing (last digit): 20 19 18 17 16 15 14 13 12

Hardcover Printing (last digit): 10 9 8 7 6 5 4 3 2 1

Printed in Hong Kong

The New Oxford Picture Dictionary contextually illustrates over 2,400 words. The book is a unique language learning tool for students of English. It provides students with a glance at American lifestyle, as well as a compendium of useful vocabulary.

The *Dictionary* is organized thematically, beginning with topics that are most useful for the "survival" needs of students in an English-speaking country. The topics move on to those of a more general nature, including those that might be used in content area classes in schools in the United States. However, pages may be used at random, depending on the students' particular needs. The book need not be taught in order.

The words depicted are those most useful for students needing basic English skills. The most common name of any given item was used for simplicity. Any regionalisms or variations will be found in the *Teacher's Guide* for that particular page.

The New Oxford Picture Dictionary contextualizes vocabulary whenever possible, thus making the language learner's task a bit easier. Verbs have been included on separate pages, but within a topic area where they are most likely to occur. However, this does not imply that these verbs only appear within these contexts.

For obvious reasons, the number of words per page has been limited. In addition, attempts have been made to place the numbers on the art consecutively, either from left to right, or, on many contextualized pages, in a circular, clockwise order.

A complete index with pronunciation guide has been included in the Appendix. For further ideas on using *The New Oxford Picture Dictionary*, see the *Teacher's Guide* and the two workbooks: *Beginner's* and *Intermediate* levels.

Also available in the program are a complete set of *Cassettes*, offering a reading of all of the words in the *Dictionary; Vocabulary Playing Cards*, featuring 40 words and the corresponding pictures on 80 cards with ideas for many games; and sets of *Wall Charts*, available in one complete package, or in three smaller packages.

iv Contents

People and Relationships	Page 2
The Family	3
The Human Body	4-5
Vegetables	6-7
Fruits	8-9
Meat, Poultry, and Seafood	10-11
Containers, Quantities, and Money	12-13
The Supermarket	14-15
Family Restaurant and Cocktail Lounge	16
Restaurant Verbs	17
Common Prepared Foods	18
Outdoor Clothes	19
Everyday Clothes	20-21
Underwear and Sleepwear	22
Jewelry and Cosmetics	23
Describing Clothes	24
Describing the Weather	25
Seasonal Verbs	26
Houses	27
The Living Room	28
The Dining Room	29
The Kitchen	30
Kitchen Verbs	31
The Bedroom	32
The Baby's Room	33
The Bathroom	34
The Utility Room	35
A Workshop	36-37
Housework and Repair Verbs	38
Medical and Dental Care	39
Ailments and Injuries	40
Treatments and Remedies	41
Firefighting and Rescue	42
Crime and Punishment	43
The City	44-45
The U.S. Postal System	46
The Public Library	47
The Armed Forces	48
Trucks	49
Cars	50-51
Bikes	52
Highway Travel	53
Public Transportation	54-55

Air Travel	Page 56
Aircraft	57
In Port	58
Pleasure Boating	59
Plants and Trees	60-61
Simple Animals	62
Insects	63
Birds	64
Fish and Reptiles	65
Mammals I	66-67
Mammals II	68-69
Map of the World	70-71
The United States of America	72-73
The Universe	74
The Space Program	75
A Classroom	76
School Verbs	77
A Science Lab	78
Math	79
Energy	80
Farming and Ranching	81
Construction	82
An Office	83
Occupations I: Main Street USA	84
Occupations II	85
Occupations III	86
Neighborhood Parks	87
Outdoor Activities	88-89
At the Beach	90-91
Team Sports	92
Ballfields	93
Individual Sports	94
Fields and Courses	95
Sports Verbs	96-97
Musical Instruments	98
Music, Dance, and Theater	99
Electronics and Photography	100
Handicrafts	101
Prepositions of Description	102
Prepositions of Motion	103
Appendix	104
Index	105

2 People and Relationships



1. woman
2. man
3. husband
4. wife

5. baby
6. parents
7. children
8. boy

9. girl
10. grandparents
11. granddaughter
12. grandson

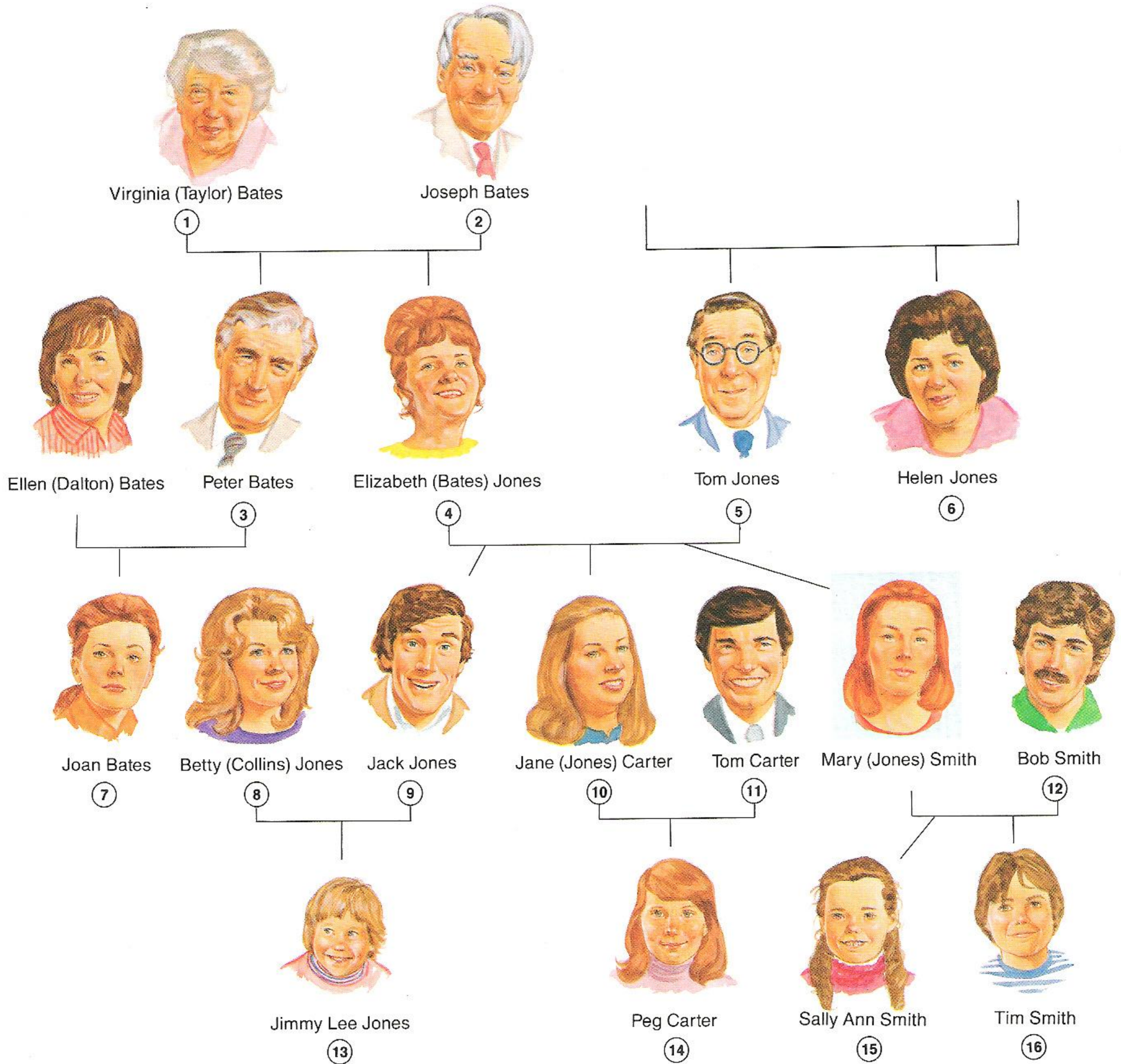

Mary Smith's Family

- 1. grandmother
- 2. grandfather
- 3. uncle
- 4. mother
- 5. father
- 6. aunt

- 7. cousin
- 8. sister-in-law
- 9. brother
- 10. sister
- 11. brother-in-law

- 12. husband
- 13. nephew
- 14. niece
- 15. daughter
- 16. son

4 The Human Body

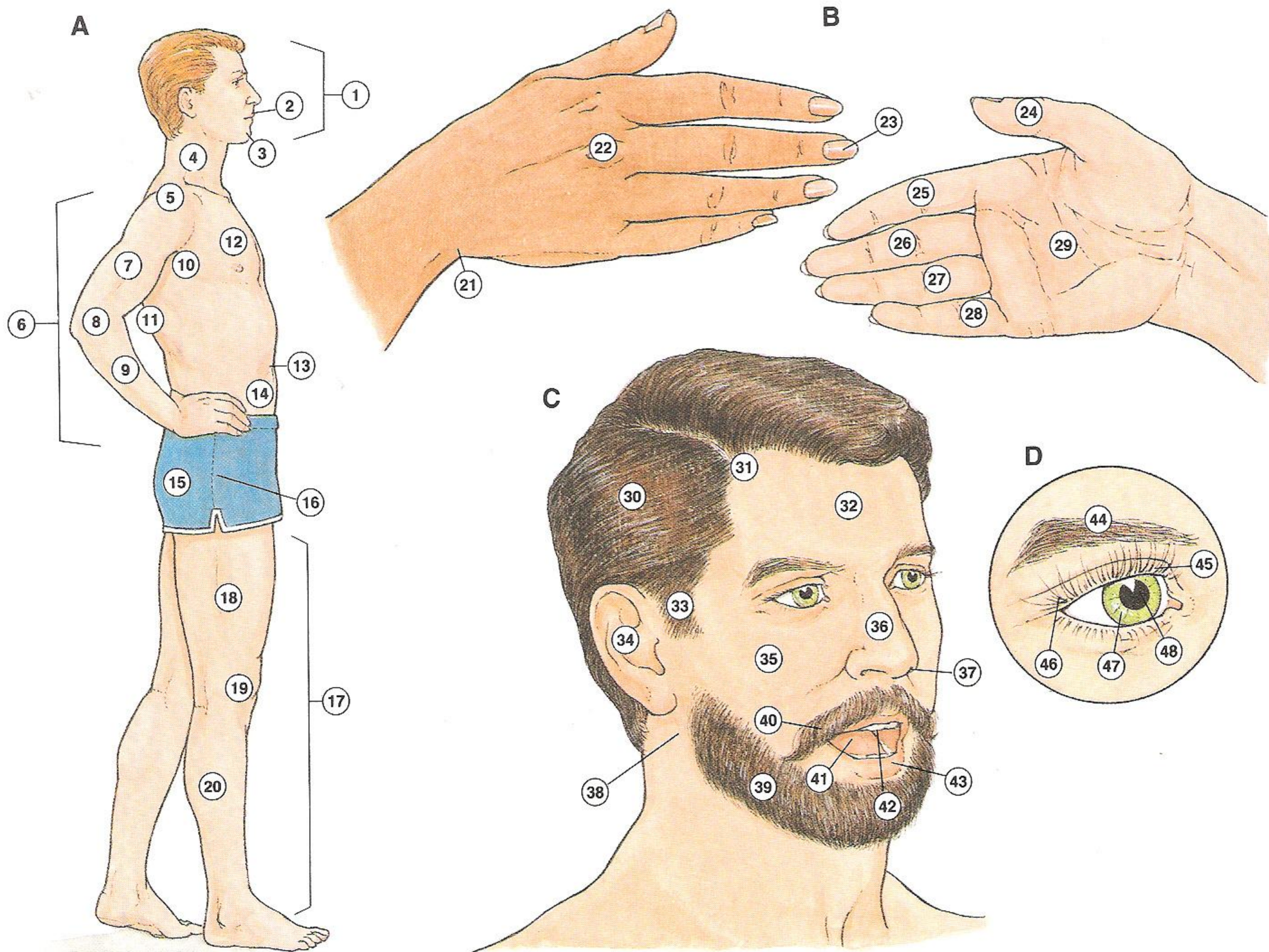

A. The Body

1. face
2. mouth
3. chin
4. neck
5. shoulder
6. arm
7. upper arm
8. elbow
9. forearm
10. armpit
11. back
12. chest
13. waist
14. abdomen
15. buttocks

16. hip
17. leg
18. thigh
19. knee
20. calf

B. The Hand

21. wrist
22. knuckle
23. fingernail
24. thumb
25. (index) finger
26. middle finger
27. ring finger
28. little finger
29. palm

C. The Head

30. hair
31. part
32. forehead
33. sideburn
34. ear
35. cheek
36. nose
37. nostril
38. jaw
39. beard
40. mustache
41. tongue
42. tooth
43. lip

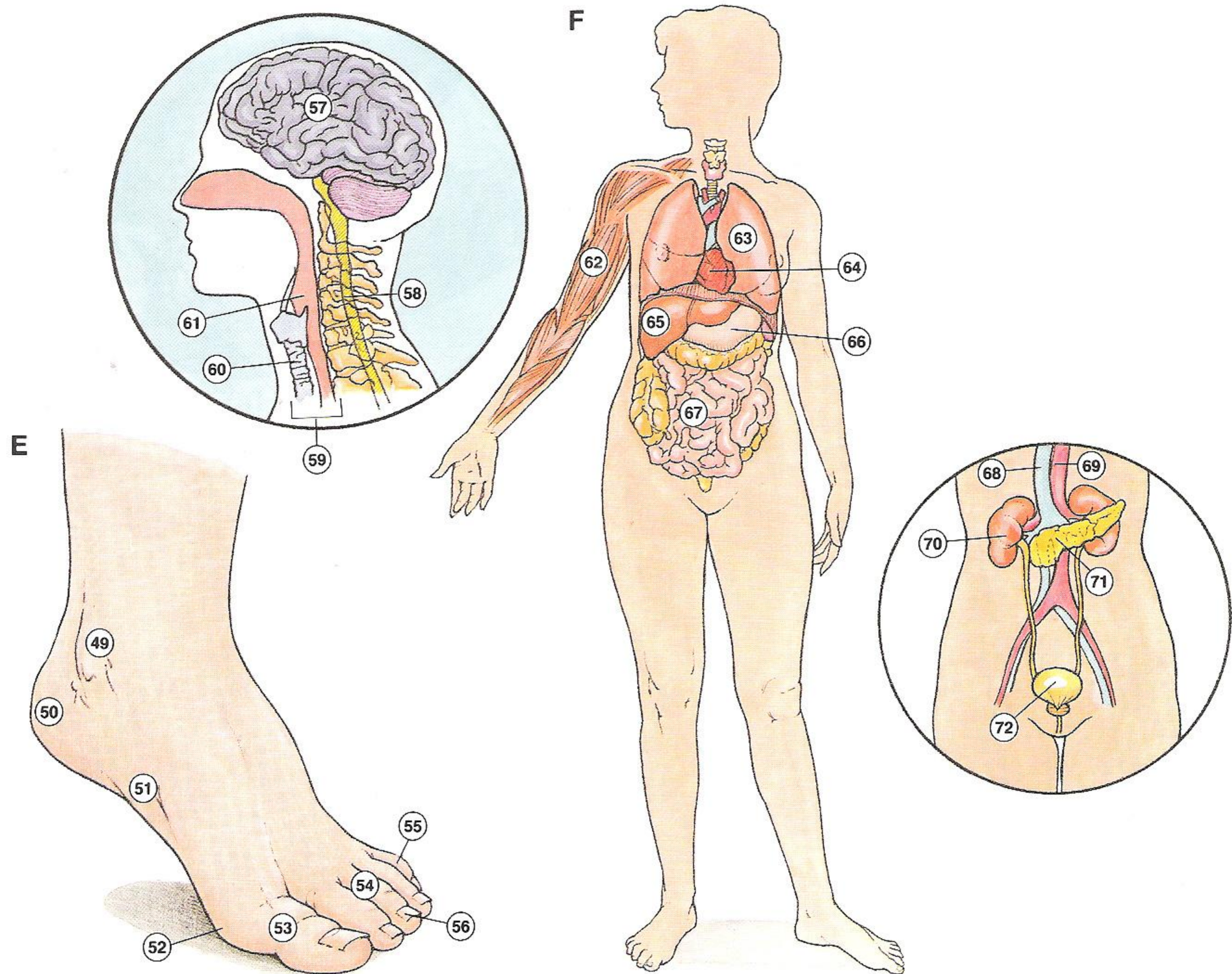

- D. The Eye**
 44. eyebrow
 45. eyelid
 46. eyelashes
 47. iris
 48. pupil

- E. The Foot**
 49. ankle
 50. heel
 51. instep
 52. ball
 53. big toe
 54. toe
 55. little toe
 56. toenail

- F. The Internal Organs**
 57. brain
 58. spinal cord
 59. throat
 60. windpipe
 61. esophagus
 62. muscle
 63. lung
 64. heart
 65. liver
 66. stomach
 67. intestines
 68. vein
 69. artery
 70. kidney
 71. pancreas
 72. bladder

6 Vegetables



1. (head of) cauliflower
2. broccoli
3. cabbage
4. brussels sprouts
5. watercress
6. lettuce

7. escarole
8. spinach
9. herb(s)
10. celery
11. artichoke
12. (ear of) corn
- a. cob

13. kidney bean(s)
14. black bean(s)
15. string bean(s)
16. lima bean(s)
17. pea(s)
- a. pod
18. asparagus



- 19. tomato(es)
- 20. cucumber(s)
- 21. eggplant
- 22. pepper(s)
- 23. potato(es)

- 24. yam
- 25. garlic
- a. clove
- 26. pumpkin
- 27. zucchini
- 28. acorn squash

- 29. radish(es)
- 30. mushroom(s)
- 31. onion(s)
- 32. carrot(s)
- 33. beet(s)
- 34. turnip

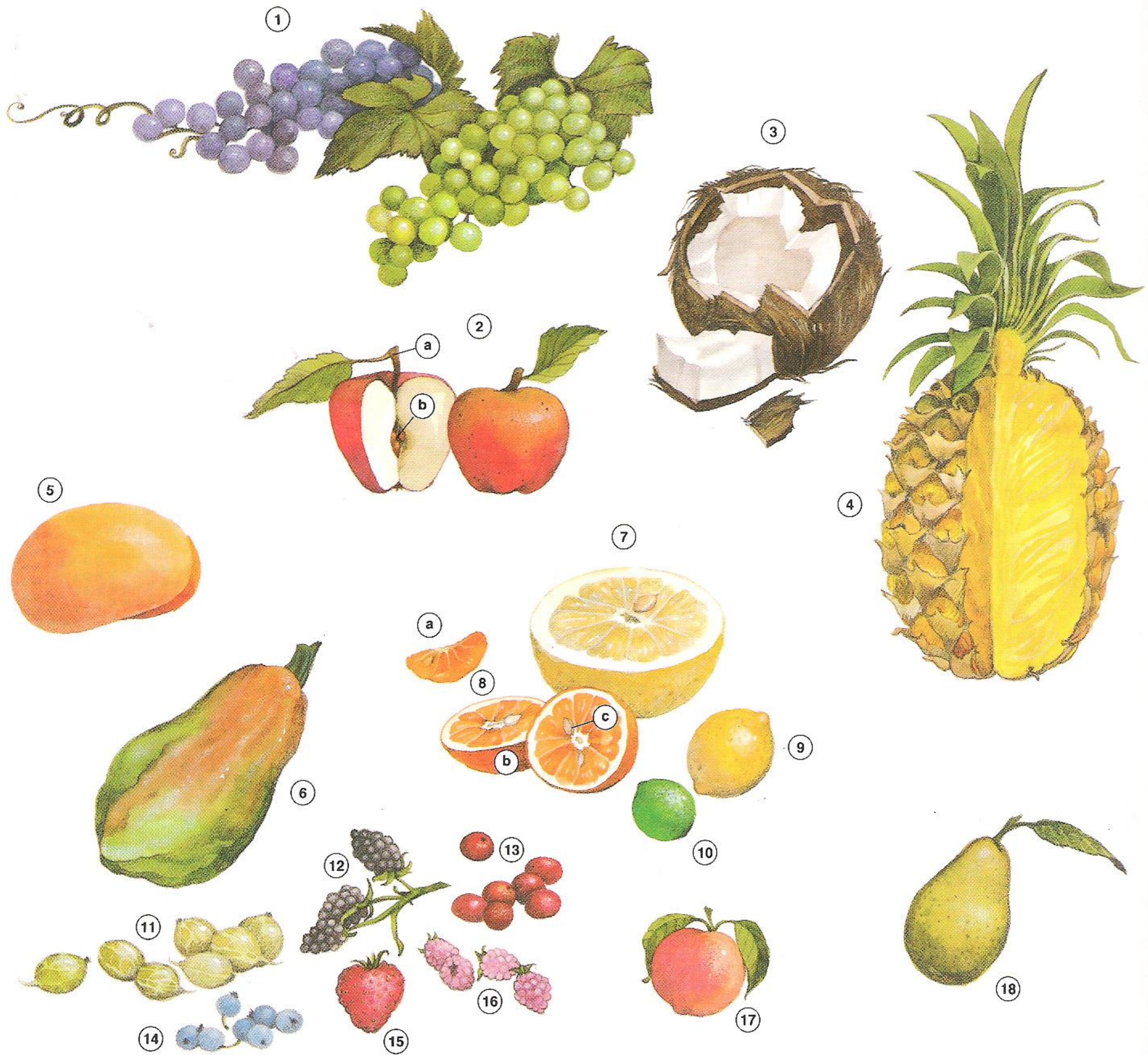

- 1. (a bunch of) grapes
- 2. apple
 - a. stem
 - b. core
- 3. coconut
- 4. pineapple
- 5. mango
- 6. papaya

- Citrus Fruits**
- 7. grapefruit
 - 8. orange
 - a. section
 - b. rind
 - c. seed
 - 9. lemon
 - 10. lime

- Berries**
- 11. gooseberries
 - 12. blackberries
 - 13. cranberries
 - 14. blueberries
 - 15. strawberry
 - 16. raspberries
 - 17. nectarine
 - 18. pear

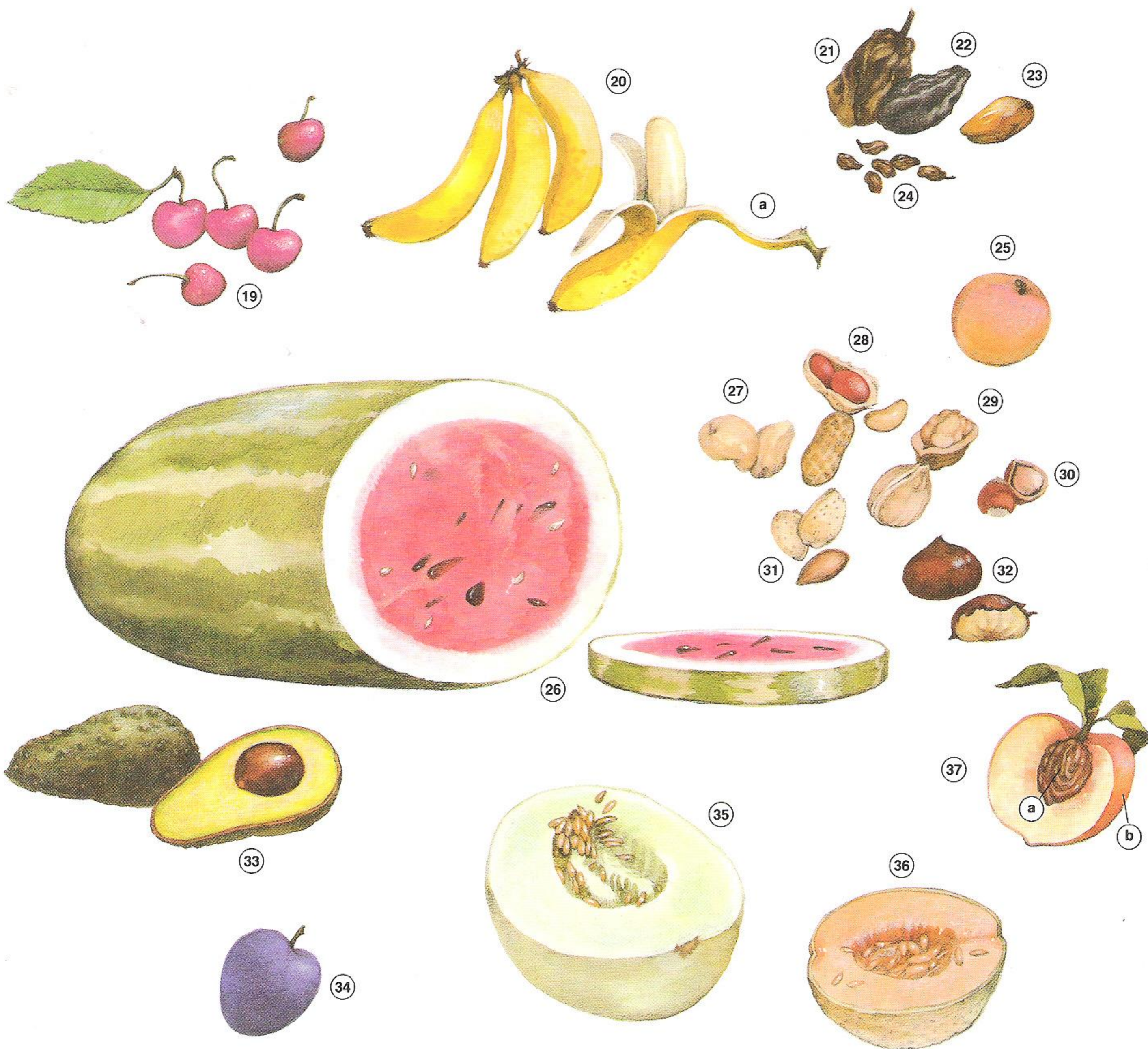

- 19. cherries
- 20. (a bunch of) bananas
- a. peel

Dried Fruits

- 21. fig
- 22. prune
- 23. date
- 24. raisin(s)

- 25. apricot
- 26. watermelon

Nuts

- 27. cashew(s)
- 28. peanut(s)
- 29. walnut(s)
- 30. hazelnut(s)
- 31. almond(s)
- 32. chestnut(s)

- 33. avocado
- 34. plum
- 35. honeydew melon
- 36. cantaloupe
- 37. peach
- a. pit
- b. skin

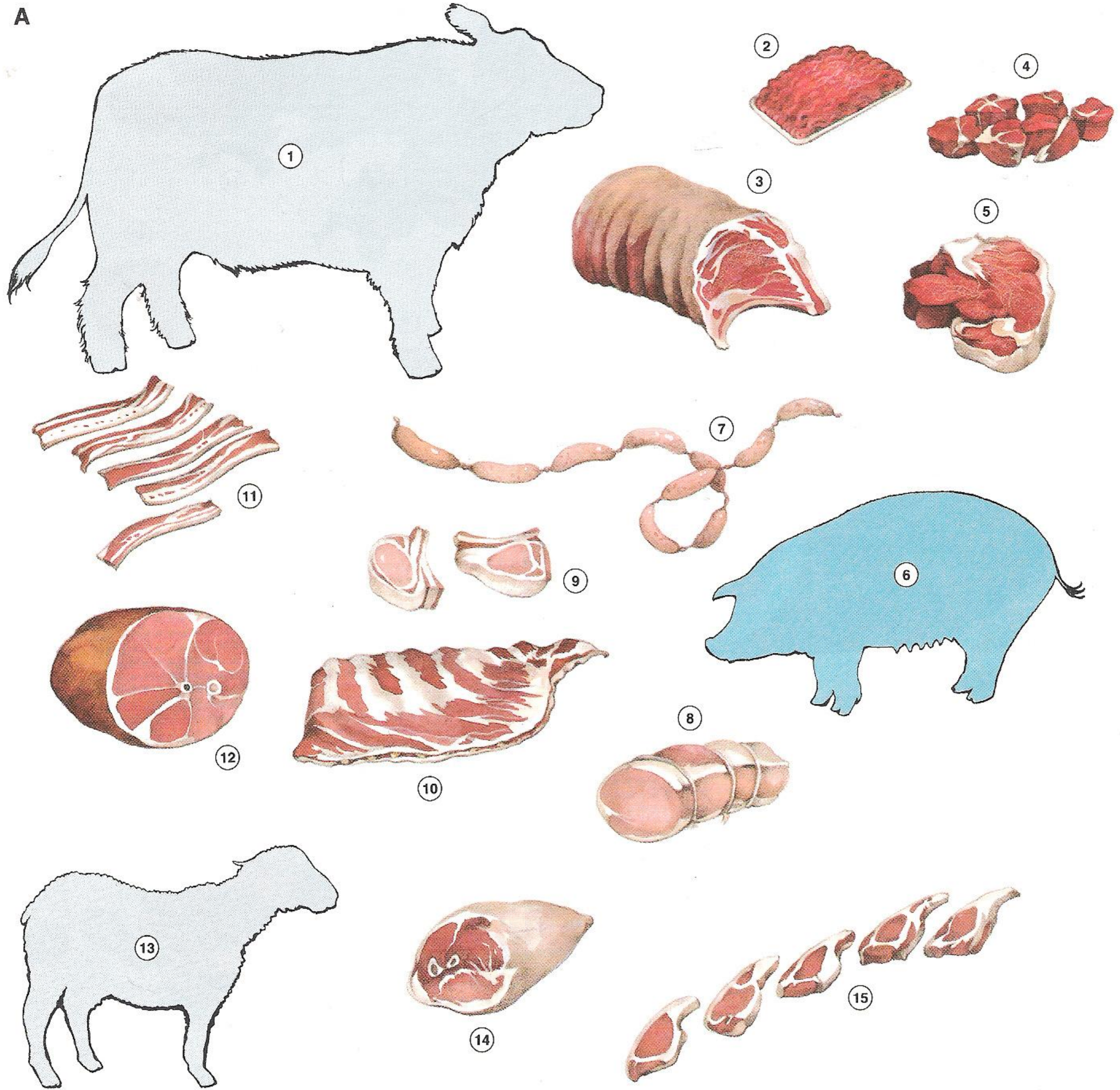

A. Meat

- 1. beef
- 2. ground beef
- 3. roast
- 4. stewing meat
- 5. steak

- 6. pork
- 7. sausage
- 8. roast
- 9. chops
- 10. spare ribs

- 11. bacon
- 12. ham
- 13. lamb
- 14. leg
- 15. chops

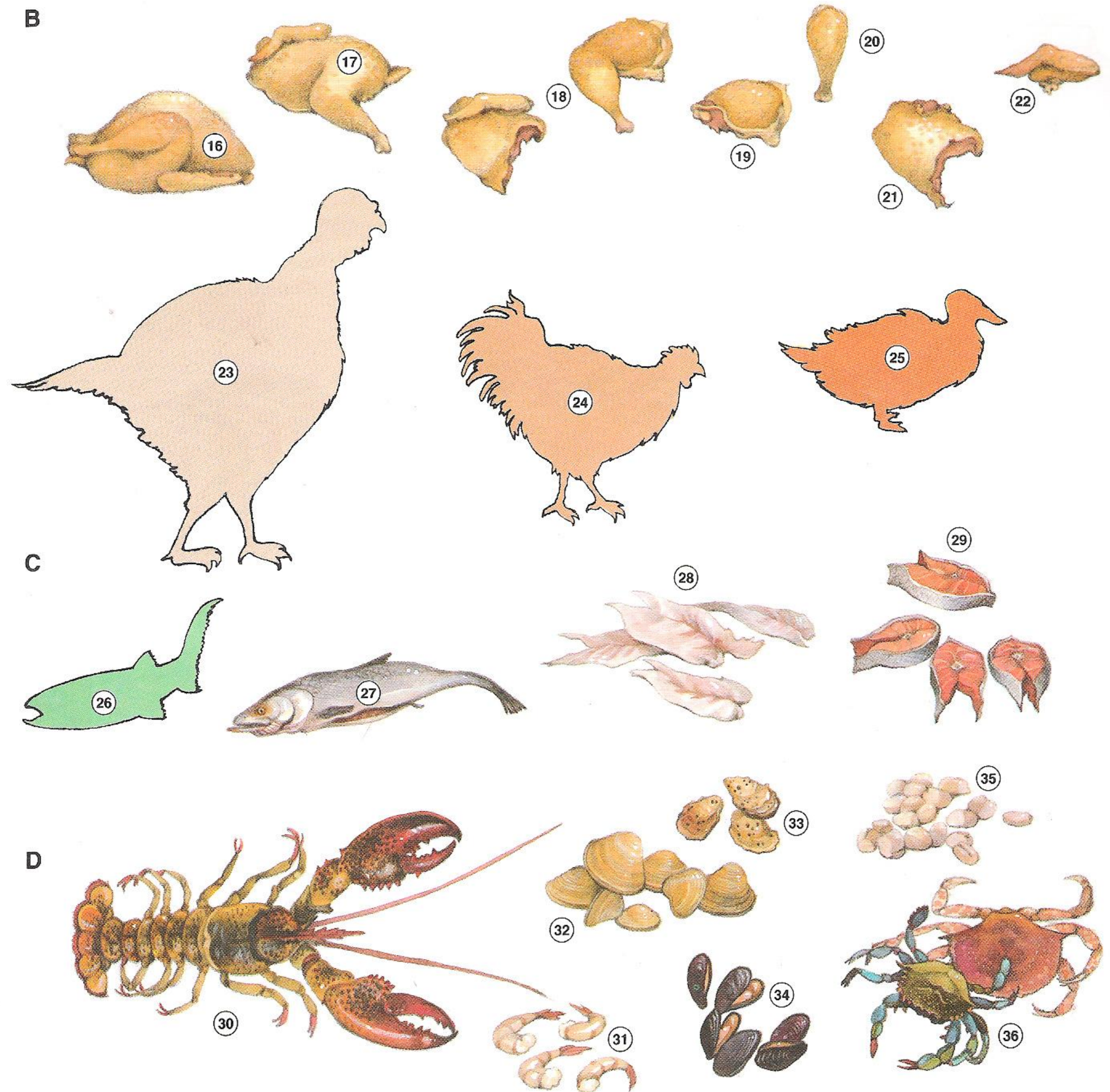

- B. Poultry**
 16. whole (chicken)
 17. split
 18. quarter
 19. thigh
 20. leg
 21. breast
 22. wing
 23. turkey

24. chicken
 25. duck
C. Seafood
 26. fish
 27. whole
 28. filet
 29. steak

- D. Shellfish**
 30. lobster
 31. shrimp
 32. clam(s)
 33. oyster(s)
 34. mussel(s)
 35. scallop(s)
 36. crab(s)

12 Containers, Quantities, and Money



- 1. carton
- 2. container
- 3. bottle
- 4. package

- 5. stick
- 6. tub
- 7. loaf
- 8. bag

- 9. jar
- 10. can
- 11. roll



- 12. box
- 13. six-pack
- 14. pump
- 15. tube
- 16. pack
- 17. book
- 18. bar

- 19. cup
- 20. glass
- 21. slice
- 22. piece
- 23. bowl
- 24. spray can

- Money**
- 25. dollar bills
 - 26. coins
 - 27. penny
 - 28. nickel
 - 29. dime
 - 30. quarter

14 The Supermarket

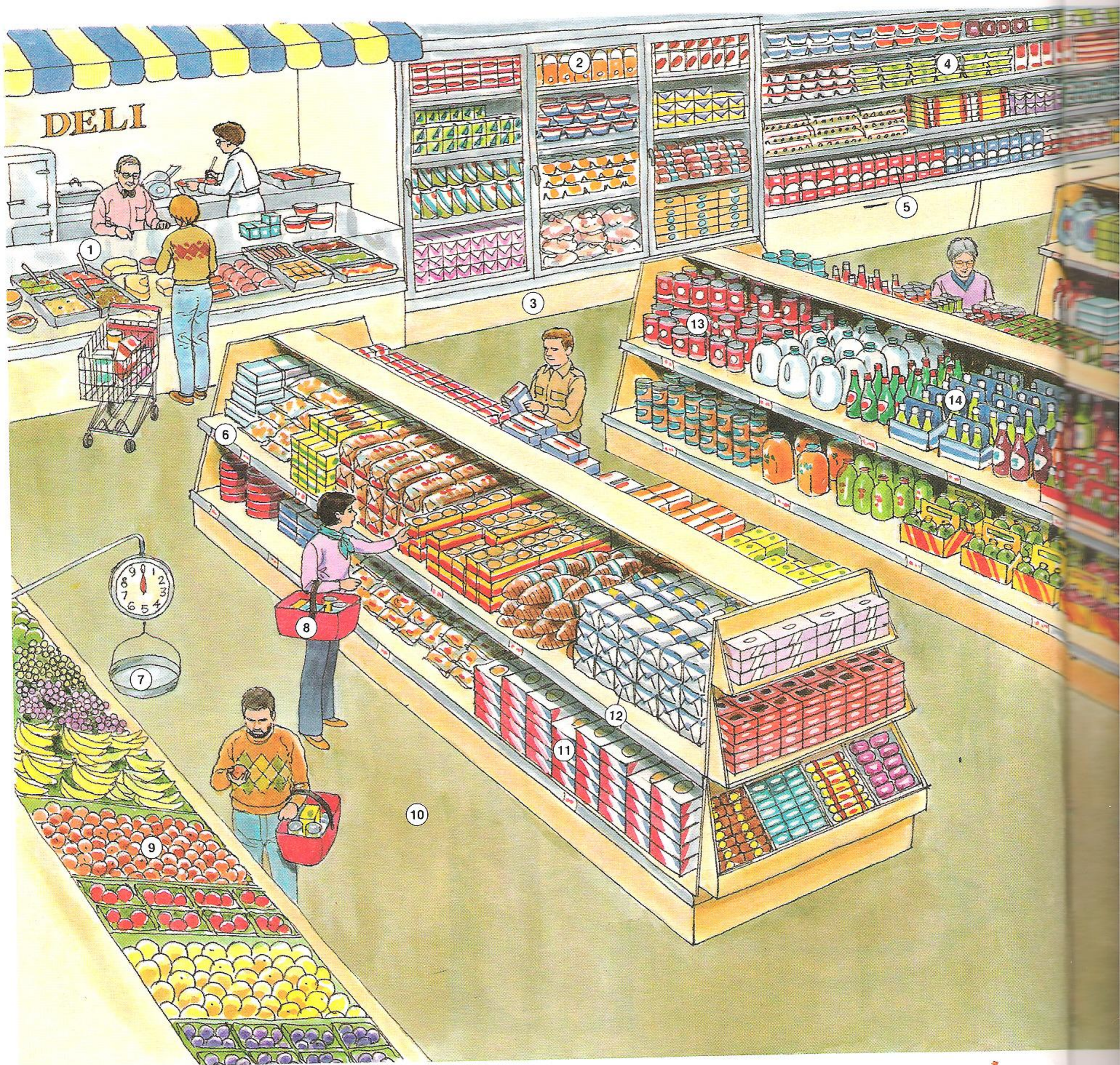

1. deli counter
2. frozen foods
3. freezer
4. dairy products
5. milk

6. shelf
7. scale
8. shopping basket
9. produce
10. aisle

11. baked goods
12. bread
13. canned goods
14. beverages

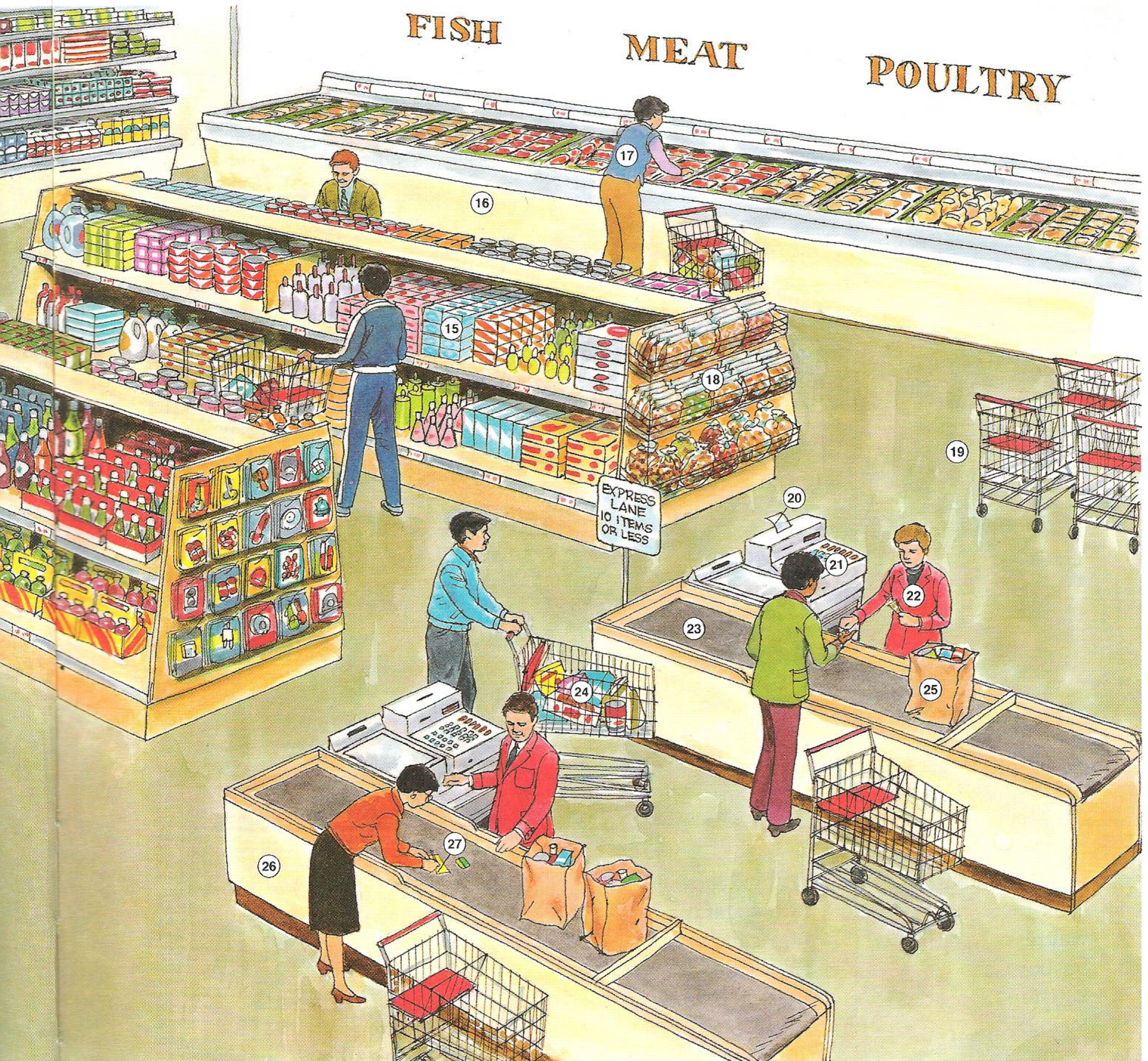

- | | | |
|---------------------|-------------------|----------------------|
| 15. household items | 20. receipt | 24. groceries |
| 16. bin | 21. cash register | 25. bag |
| 17. customer | 22. cashier | 26. checkout counter |
| 18. snacks | 23. conveyor belt | 27. check |
| 19. shopping cart | | |

16 Family Restaurant and Cocktail Lounge



A. Family Restaurant

1. cook
2. waitress
3. busboy
4. ketchup
5. waiter
6. apron
7. menu
8. high chair
9. booth
10. straw
11. soft drink

12. jukebox
13. sugar (packet)
14. check
15. tea
16. sandwich

B. Cocktail Lounge

17. corkscrew
18. cork
19. wine
20. tap
21. bartender

22. liquor (bottle)
23. beer
24. bar
25. bar stool
26. pipe
27. coaster
28. (book of) matches
29. ashtray
30. lighter
31. cigarette
32. cocktail waitress
33. tray



- 1. eat
- 2. drink
- 3. serve
- 4. cook
- 5. order

- 6. clear
- 7. pay
- 8. set (the table)
- 9. give
- 10. take

- 11. spread
- 12. hold
- 13. light
- 14. burn

18 Common Prepared Foods

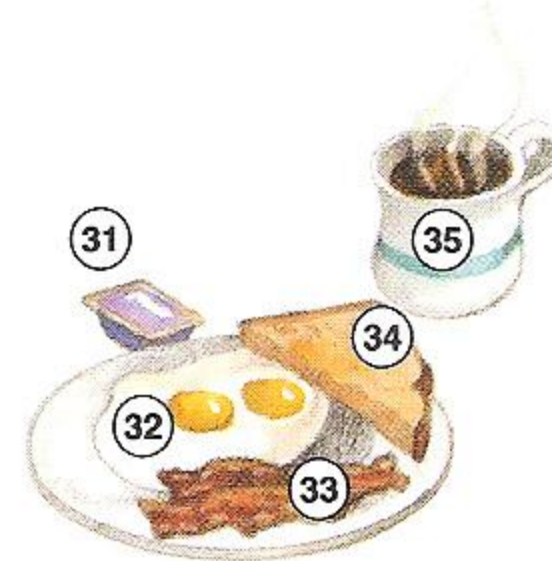
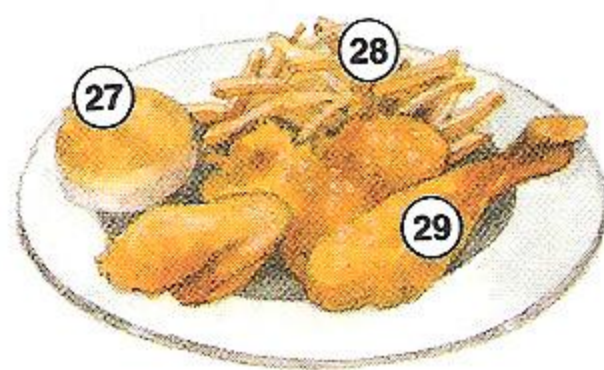
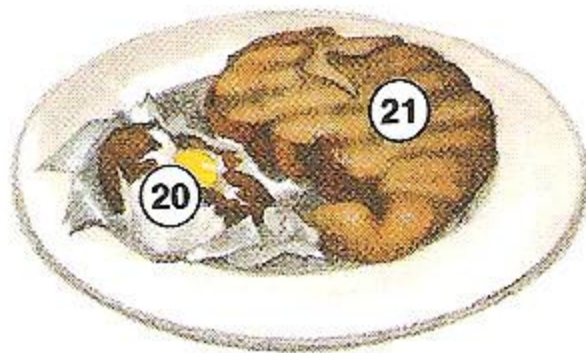
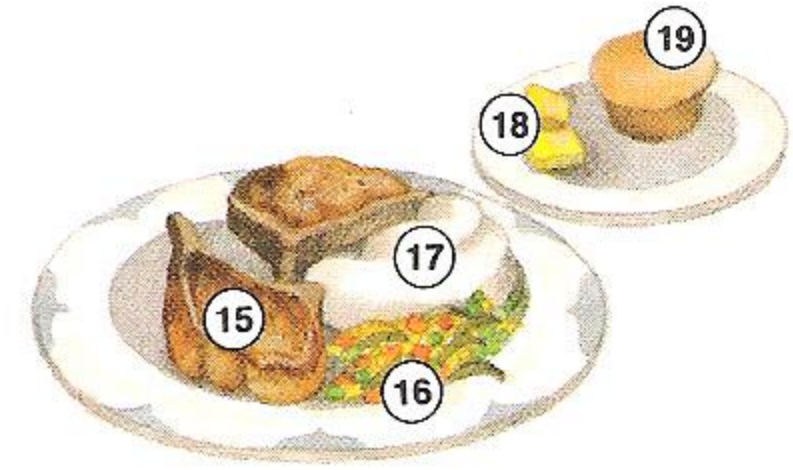
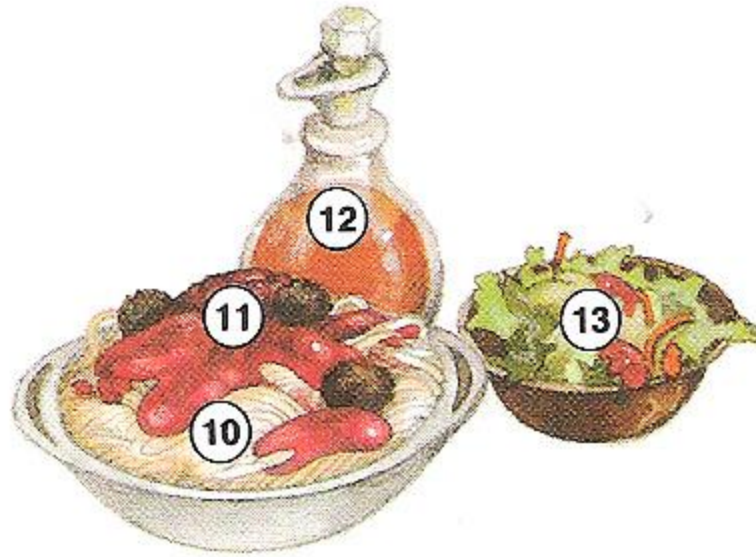
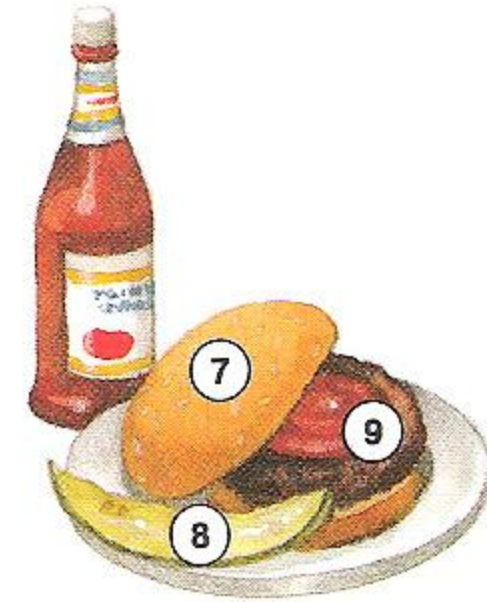
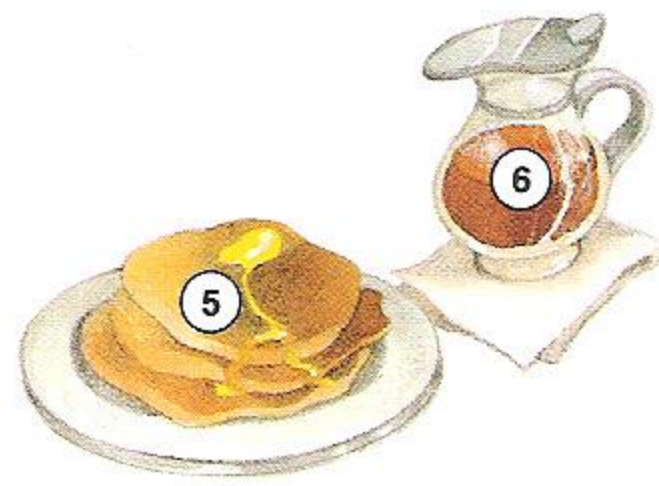
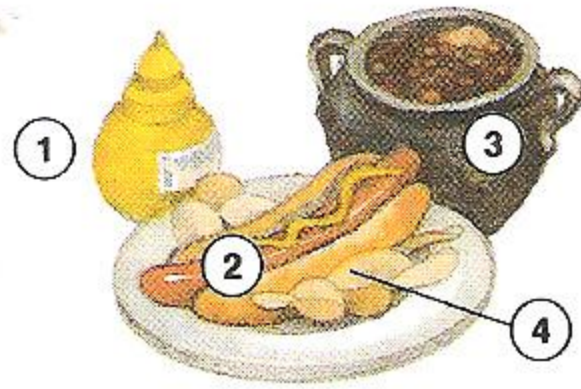

1. mustard
2. hot dog
3. baked beans
4. potato chips
5. pancakes
6. syrup
7. bun
8. pickle
9. hamburger
10. spaghetti
11. meatballs
12. salad dressing

13. tossed salad
14. beef stew
15. pork chops
16. mixed vegetables
17. mashed potatoes
18. butter
19. roll
20. baked potato
21. steak
22. cookie
23. sundae
24. taco

25. egg roll
26. strawberry shortcake
27. biscuit
28. french fries
29. fried chicken
30. pizza
31. jelly
32. (sunnyside-up) egg
33. bacon
34. toast
35. coffee
36. ice cream cone



- | | | |
|-----------------------|--------------------------|----------------------|
| 1. gloves | 10. earmuffs | 18. hat |
| 2. cap | 11. mittens | 19. scarf |
| 3. flannel shirt | 12. down vest | 20. overcoat |
| 4. backpack | 13. (turtleneck) sweater | 21. boots |
| 5. windbreaker | 14. tights | 22. beret |
| 6. (blue) jeans | 15. ice skates | 23. (V-neck) sweater |
| 7. (crewneck) sweater | 16. ski cap | 24. coat |
| 8. parka | 17. jacket | 25. rain boots |
| 9. hiking boots | | |

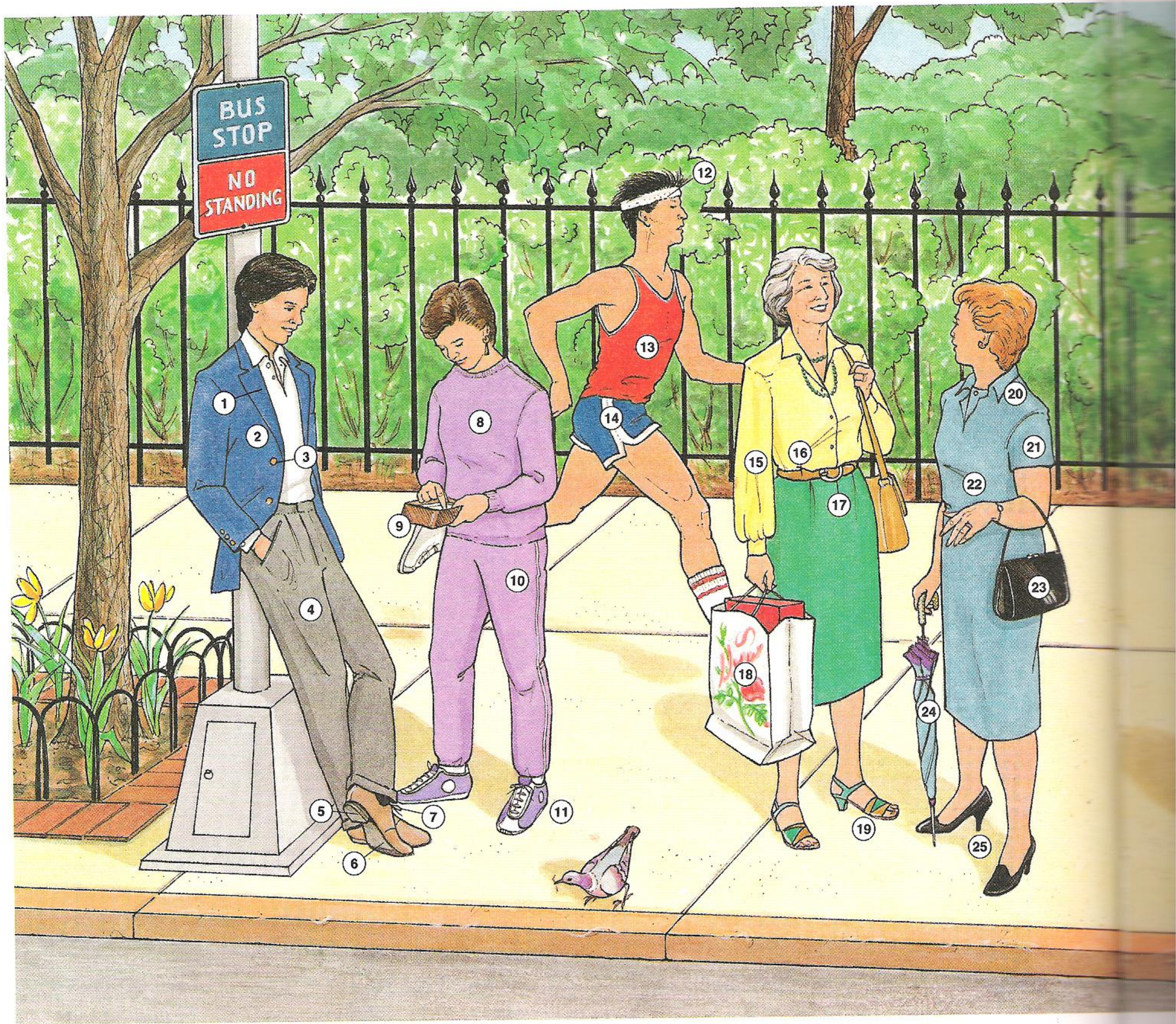

- 1. lapel
- 2. blazer
- 3. button
- 4. slacks
- 5. heel
- 6. sole
- 7. shoelace
- 8. sweatshirt

- 9. wallet
- 10. sweatpants
- 11. sneakers
- 12. sweatband
- 13. tank top
- 14. shorts
- 15. long sleeve
- 16. belt

- 17. buckle
- 18. shopping bag
- 19. sandal
- 20. collar
- 21. short sleeve
- 22. dress
- 23. purse
- 24. umbrella
- 25. (high) heels



- 26. cardigan
- 27. (corduroy) pants
- 28. hard hat
- 29. T-shirt
- 30. overalls
- 31. lunch box
- 32. (construction) boots
- 33. jacket

- 34. blouse
- 35. (shoulder) bag
- 36. skirt
- 37. briefcase
- 38. raincoat
- 39. vest
- 40. three-piece suit
- 41. pocket

- 42. loafer
- 43. cap
- 44. glasses
- 45. uniform
- 46. shirt
- 47. tie
- 48. newspaper
- 49. shoe



- 1. undershirt
- 2. boxer shorts
- 3. underpants
- 4. athletic supporter
- 5. pantyhose
- 6. stockings
- 7. long johns

- 8. half slip
- 9. camisole
- 10. full slip
- 11. (bikini) panties
- 12. briefs
- 13. bra(ssiere)
- 14. garter belt

- 15. girdle
- 16. knee socks
- 17. socks
- 18. slippers
- 19. pajamas
- 20. bathrobe
- 21. nightgown

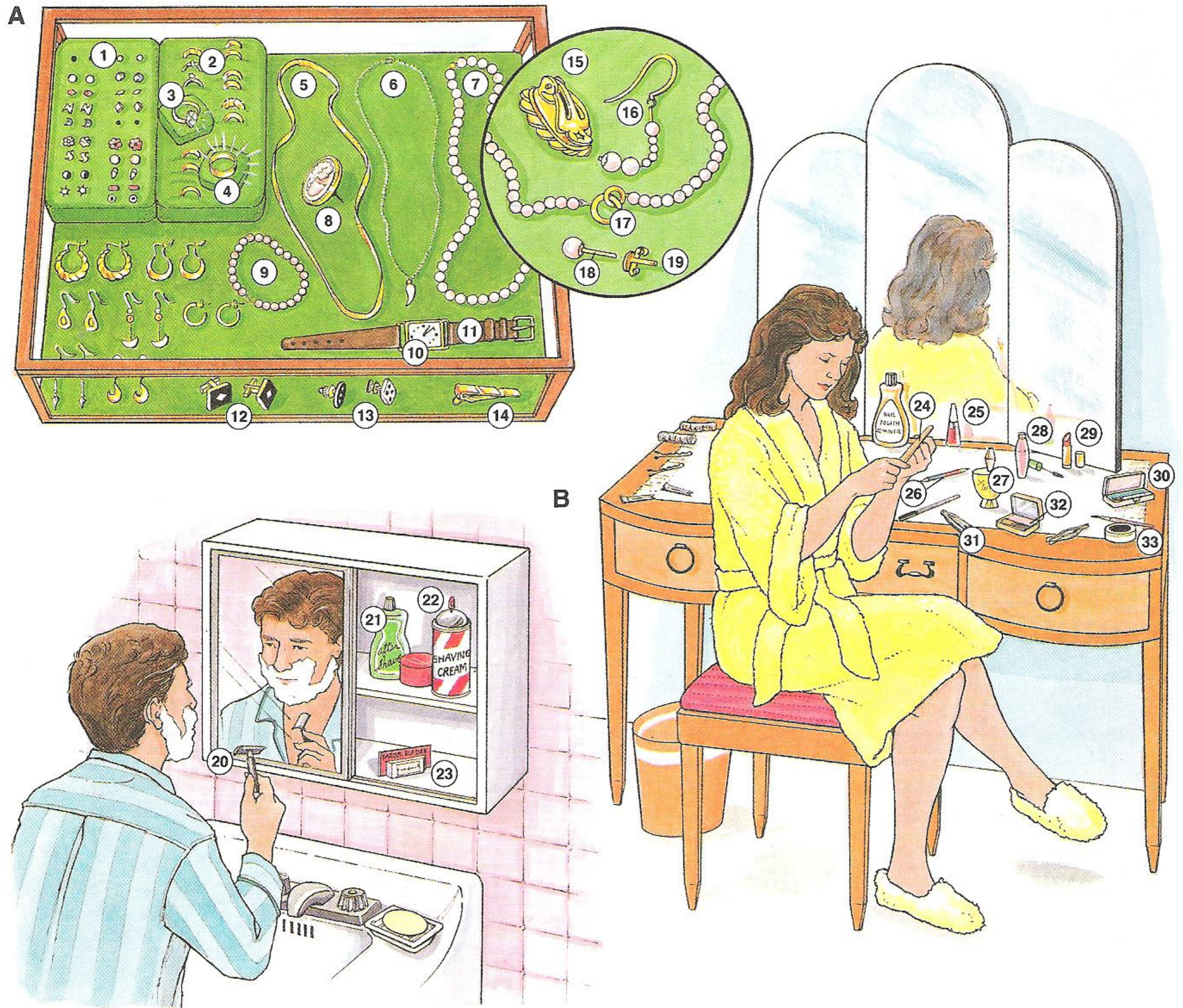

A. Jewelry

- 1. earrings
- 2. ring(s)
- 3. engagement ring
- 4. wedding ring
- 5. chain
- 6. necklace
- 7. (strand of) beads
- 8. pin
- 9. bracelet
- 10. watch
- 11. watchband
- 12. cuff links

- 13. tie pin
- 14. tie clip
- 15. clip-on earring
- 16. pierced earring
- 17. clasp
- 18. post
- 19. back

B. Toiletries and Makeup

- 20. razor
- 21. after-shave lotion
- 22. shaving cream
- 23. razor blades

- 24. emery board
- 25. nail polish
- 26. eyebrow pencil
- 27. perfume
- 28. mascara
- 29. lipstick
- 30. eye shadow
- 31. nail clippers
- 32. blush
- 33. eyeliner



1. short
2. long
3. tight
4. loose
5. dirty
6. clean
7. small
8. big

9. light
10. dark
11. high
12. low
13. new
14. old
15. open

16. closed
17. striped
18. checked
19. polka dot
20. solid
21. print
22. plaid

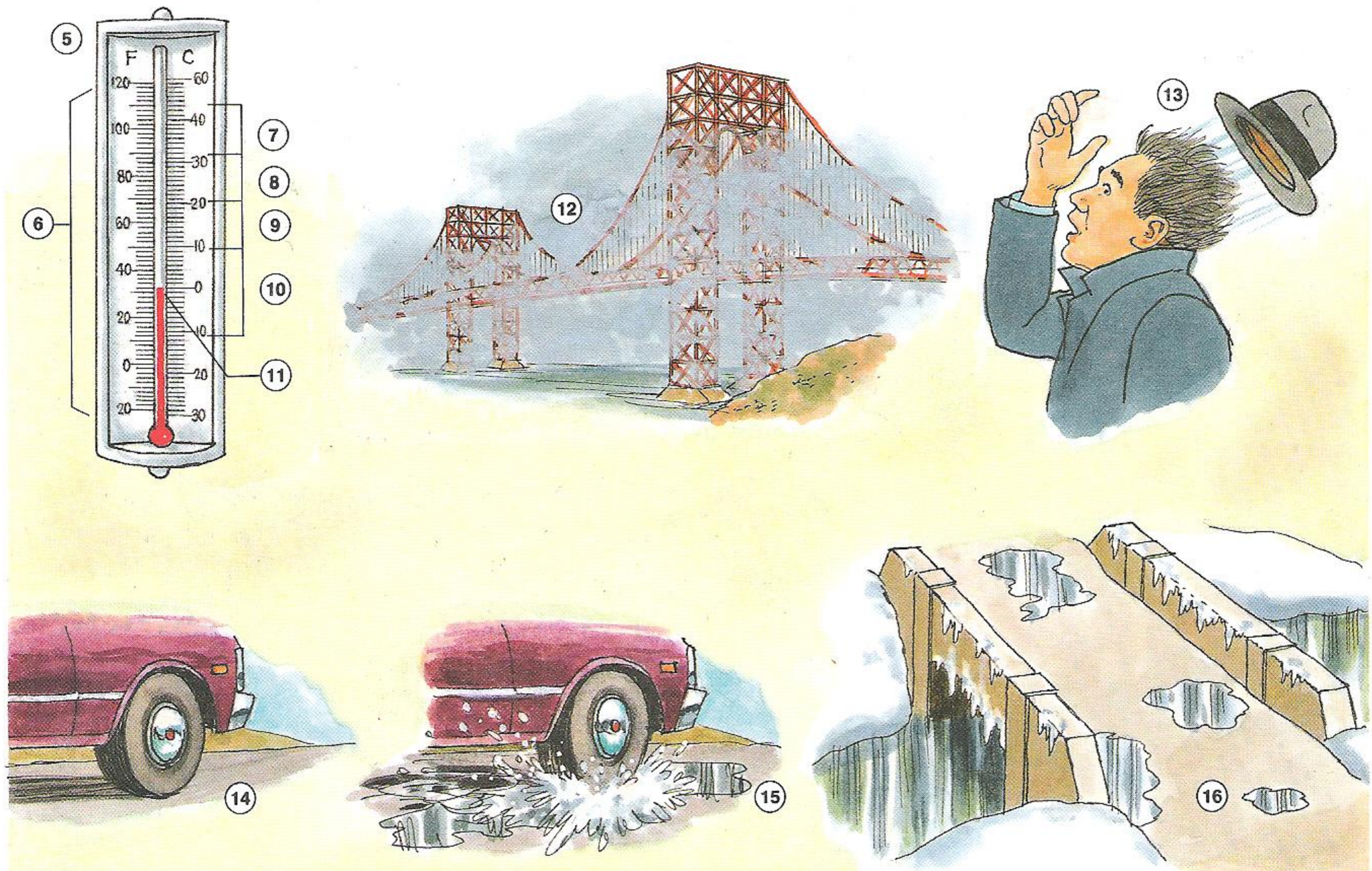
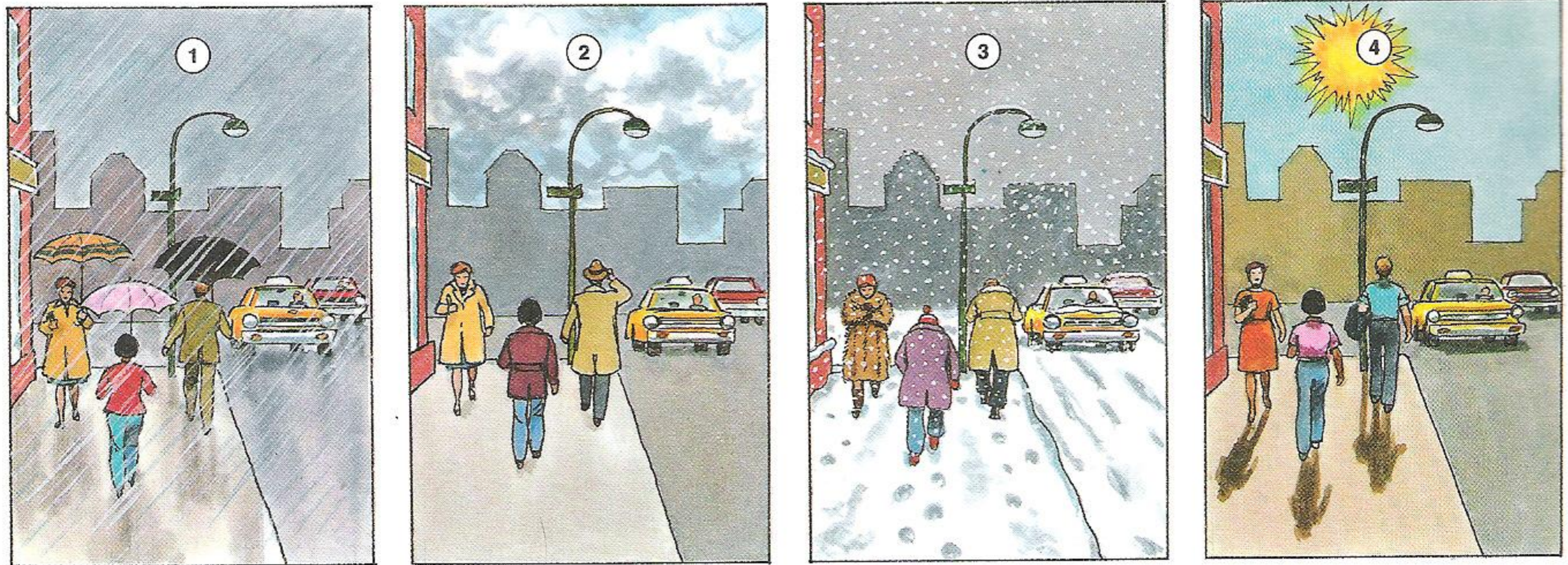

- 1. rainy
- 2. cloudy
- 3. snowy
- 4. sunny
- 5. thermometer
- 6. temperature

雨
天

- 7. hot
- 8. warm
- 9. cool
- 10. cold
- 11. freezing

暖
冷
结冰

- 12. foggy
- 13. windy
- 14. dry
- 15. wet
- 16. icy

雾
风
湿
冰

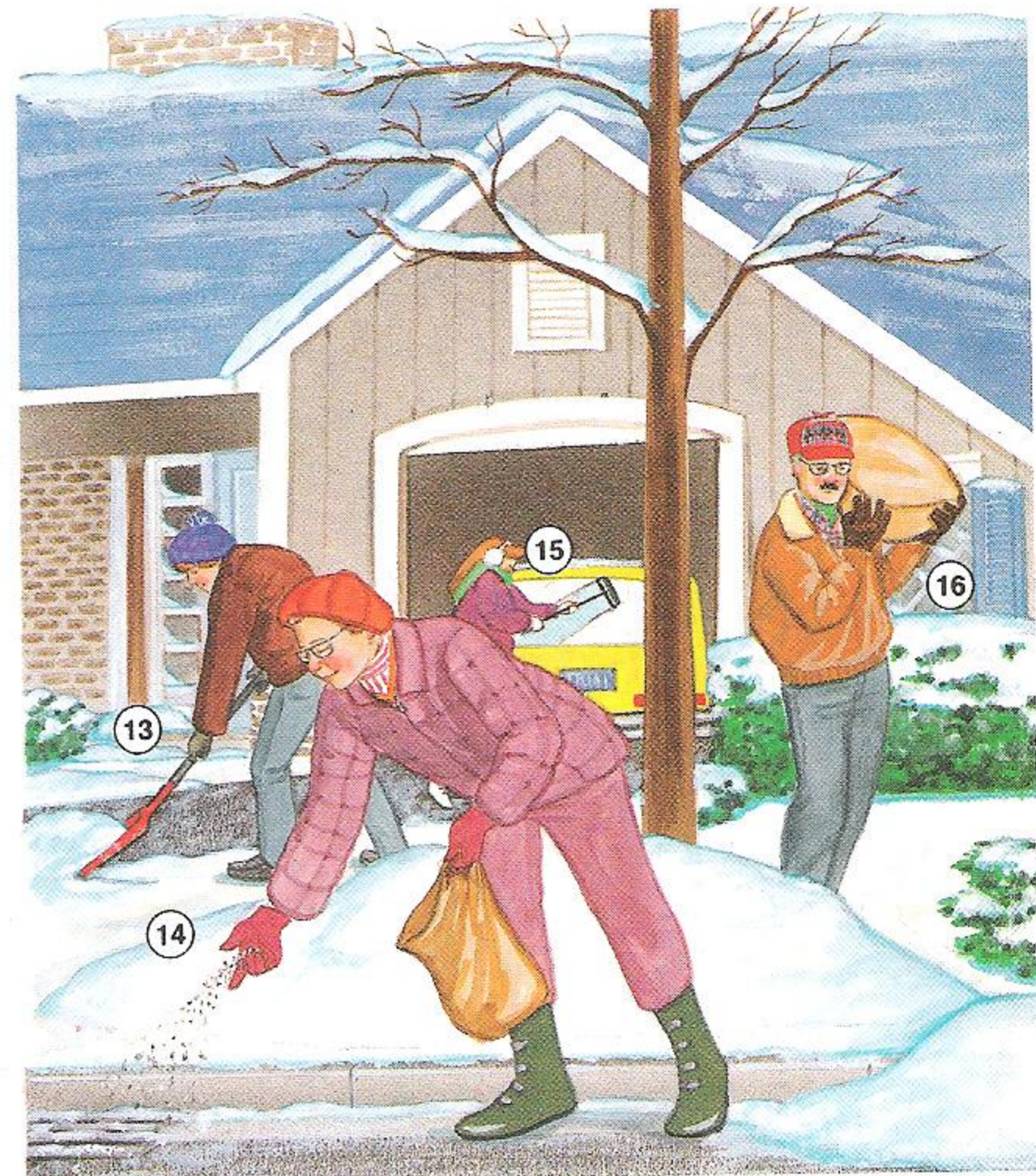
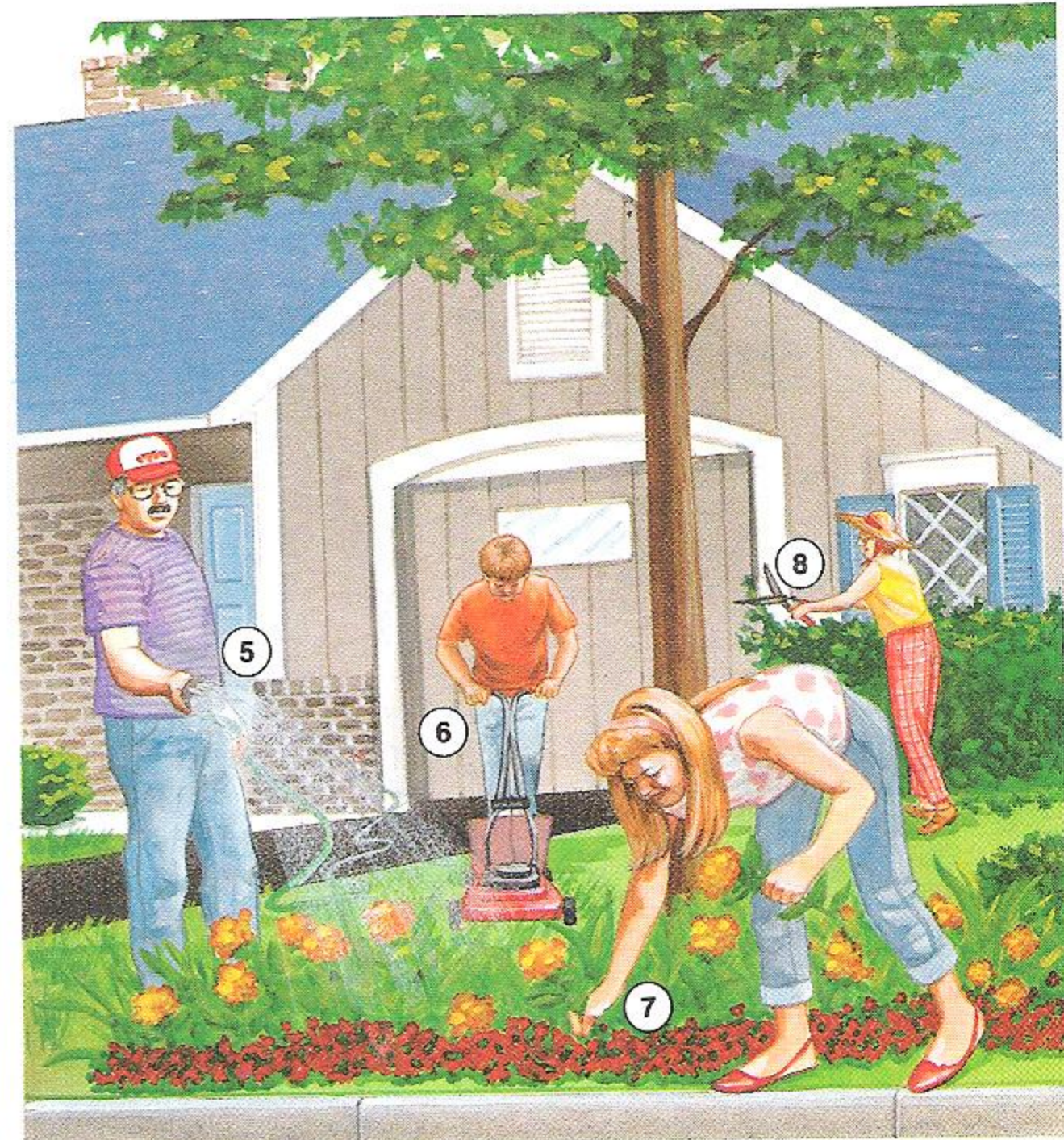
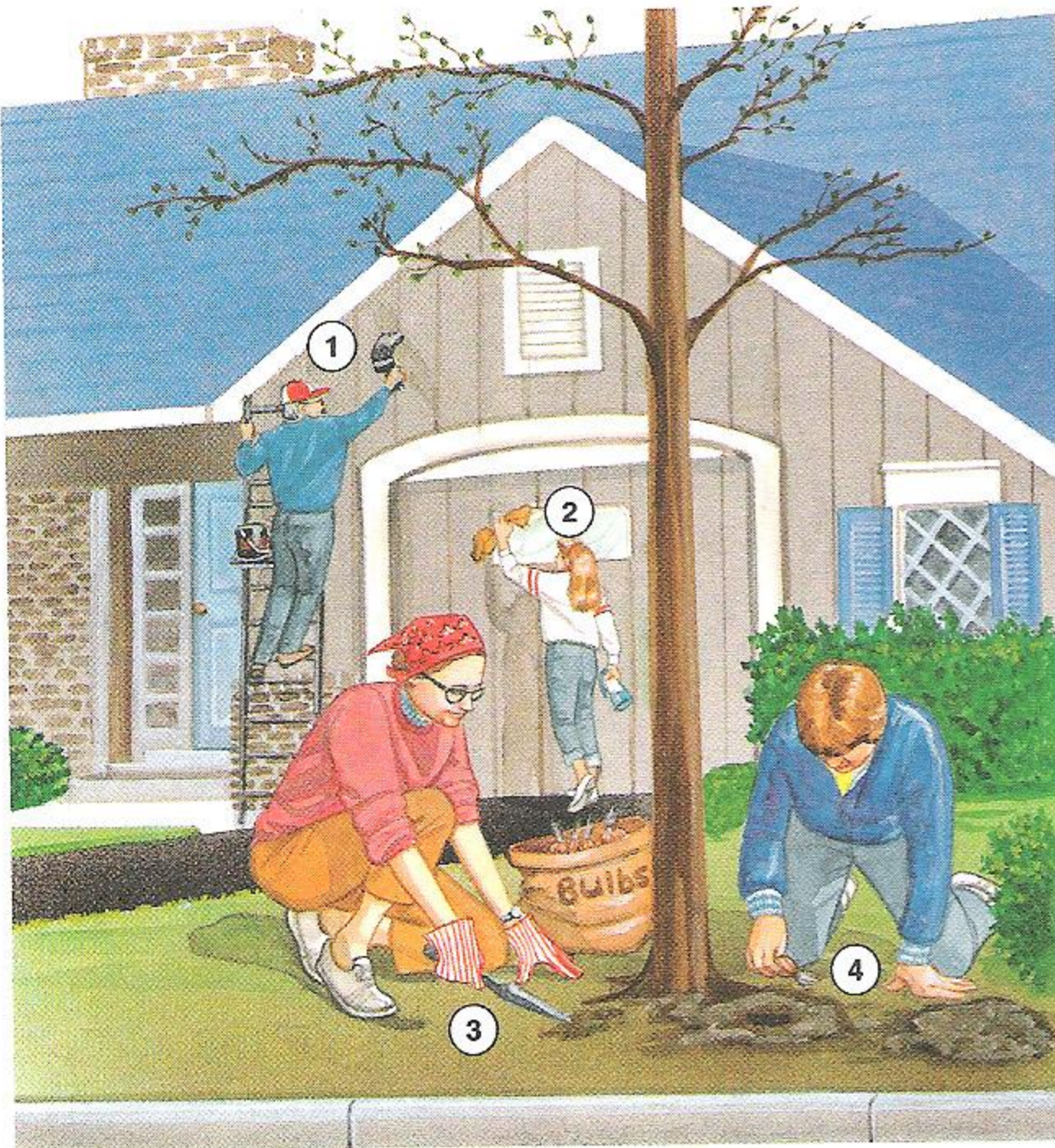

Spring

- 1. paint
- 2. clean
- 3. dig
- 4. plant

Summer

- 5. water
- 6. mow
- 7. pick
- 8. trim

Fall

- 9. fill
- 10. rake
- 11. chop
- 12. push

Winter

- 13. shovel
- 14. sand
- 15. scrape
- 16. carry

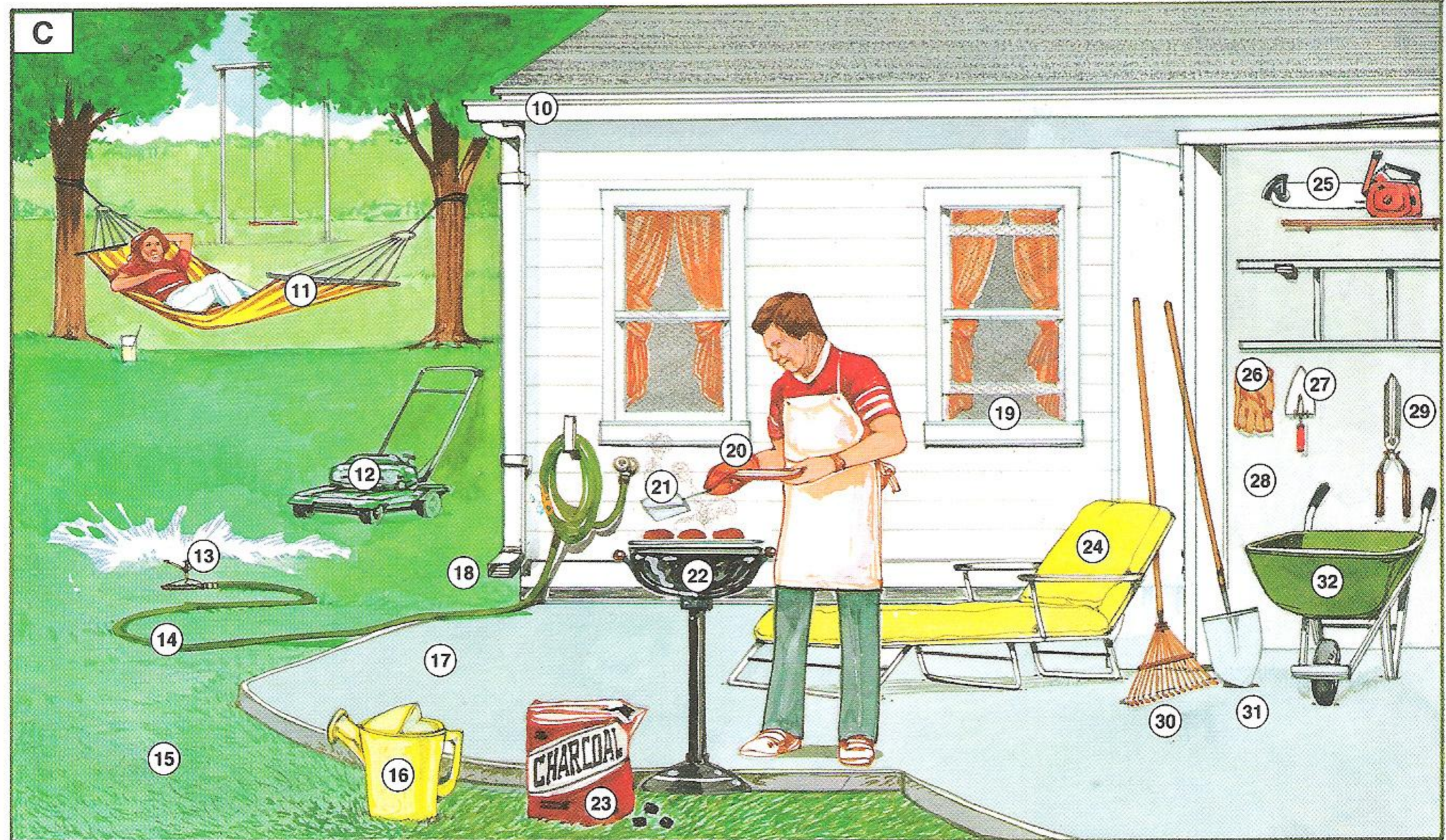
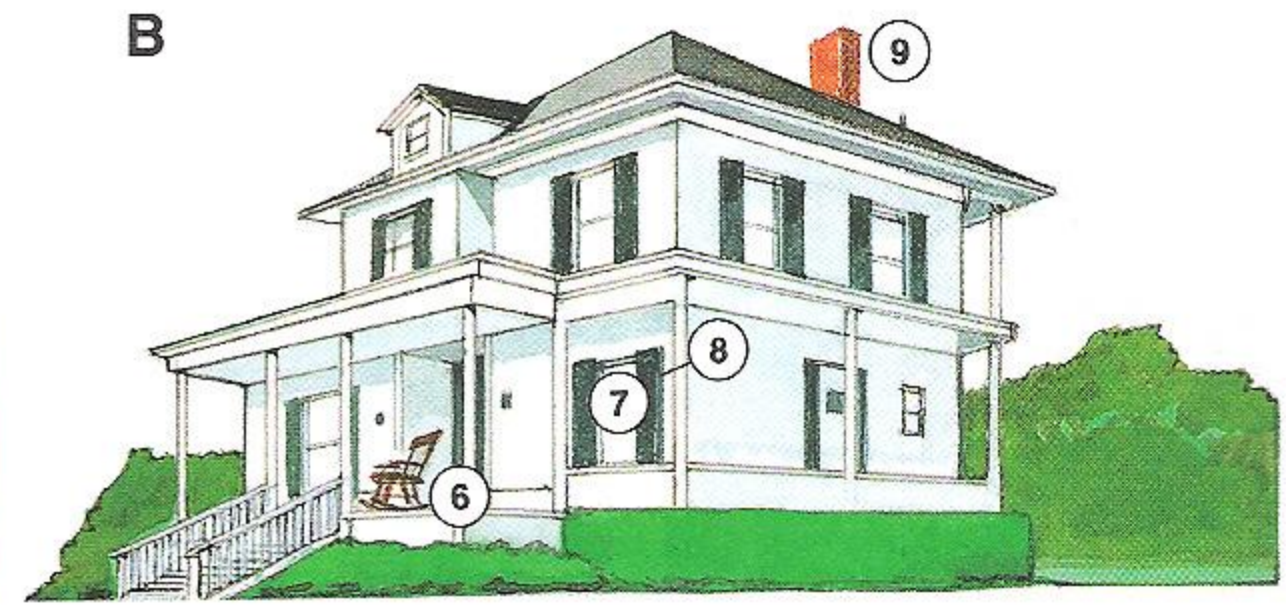
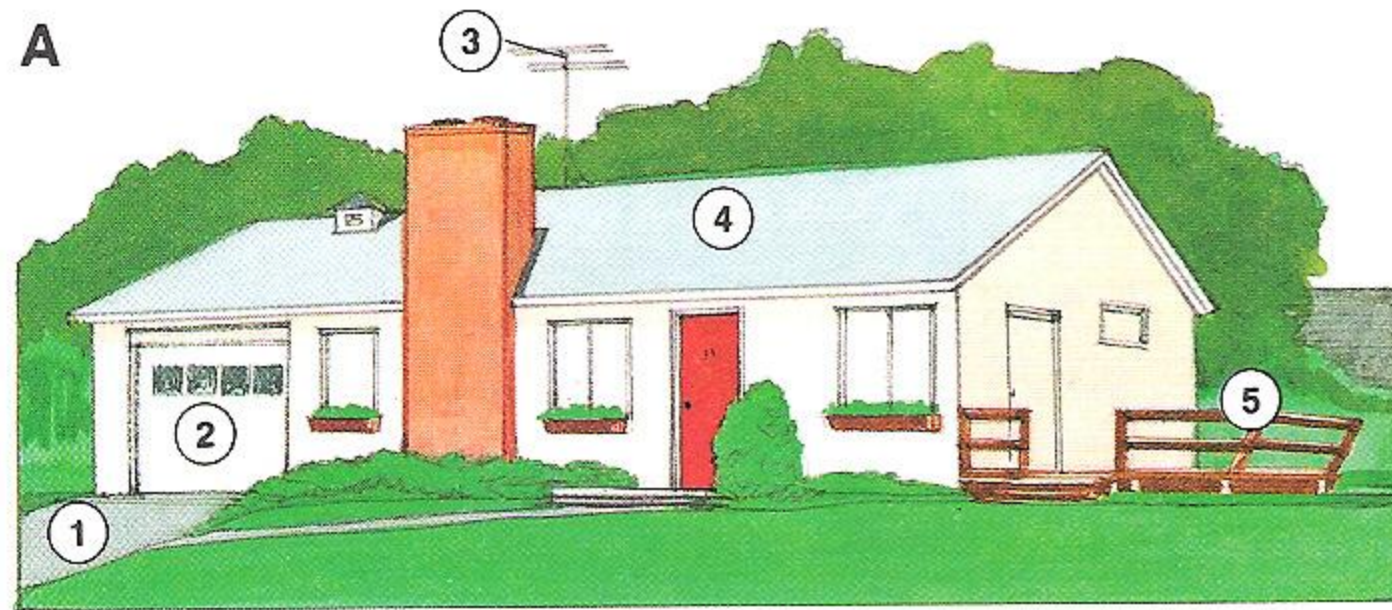

A. Ranch House

- 1. driveway
- 2. garage
- 3. TV antenna
- 4. roof
- 5. deck

B. Colonial-style House

- 6. porch
- 7. window
- 8. shutter
- 9. chimney

C. The Backyard

- 10. gutter
- 11. hammock
- 12. lawn mower
- 13. sprinkler
- 14. garden hose
- 15. grass
- 16. watering can
- 17. patio
- 18. drainpipe
- 19. screen
- 20. mitt

- 21. spatula
- 22. grill
- 23. charcoal briquettes
- 24. lounge chair
- 25. power saw
- 26. work gloves
- 27. trowel
- 28. toolshed
- 29. hedge clippers
- 30. rake
- 31. shovel
- 32. wheelbarrow

28 The Living Room

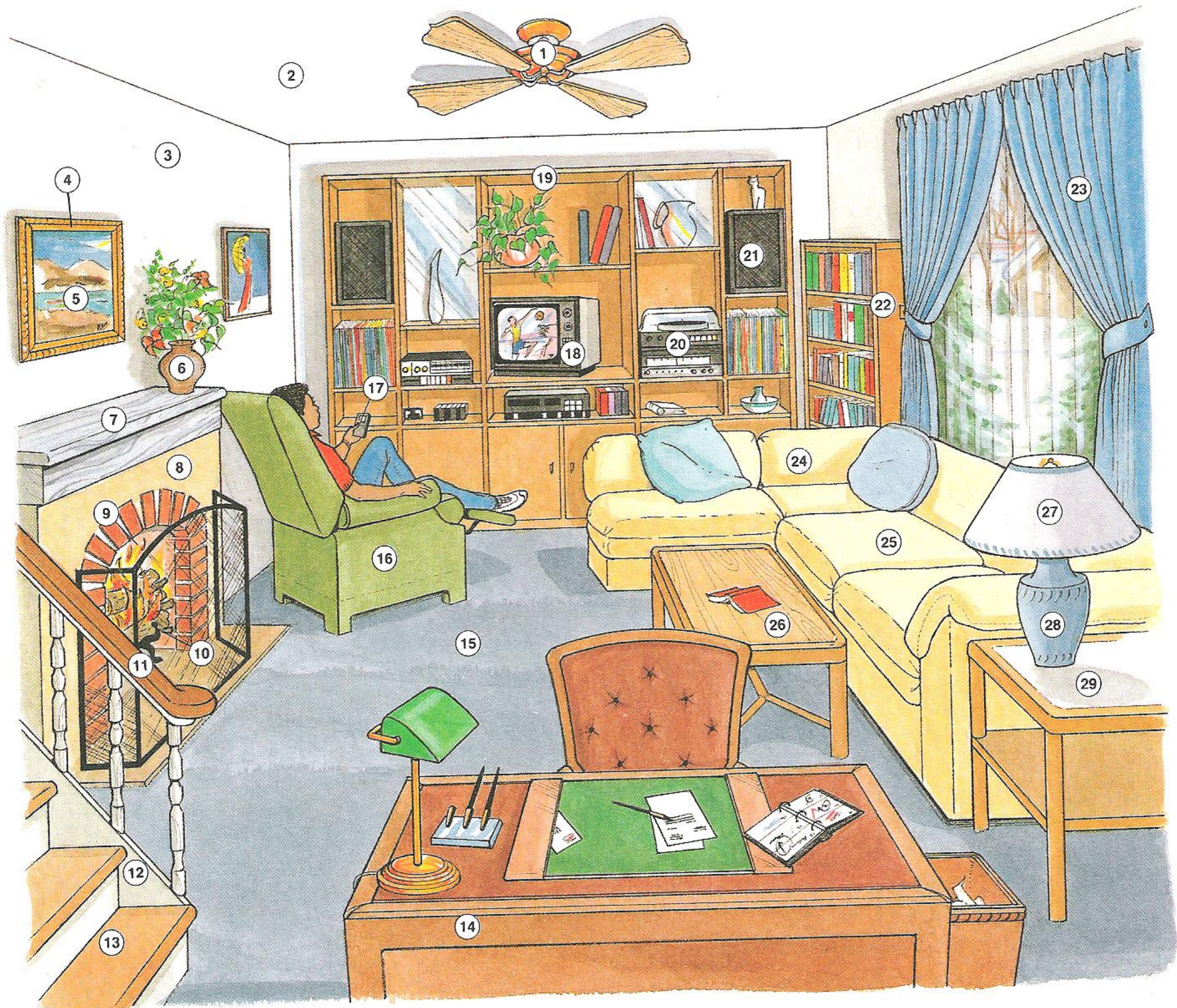

1. ceiling fan
2. ceiling
3. wall
4. frame
5. painting
6. vase
7. mantel
8. fireplace
9. fire
10. log

11. banister
12. staircase
13. step
14. desk
15. wall-to-wall carpeting
16. recliner
17. remote control
18. television
19. wall unit
20. stereo system

21. speaker
22. bookcase
23. drapes
24. cushion
25. sofa
26. coffee table
27. lampshade
28. lamp
29. end table

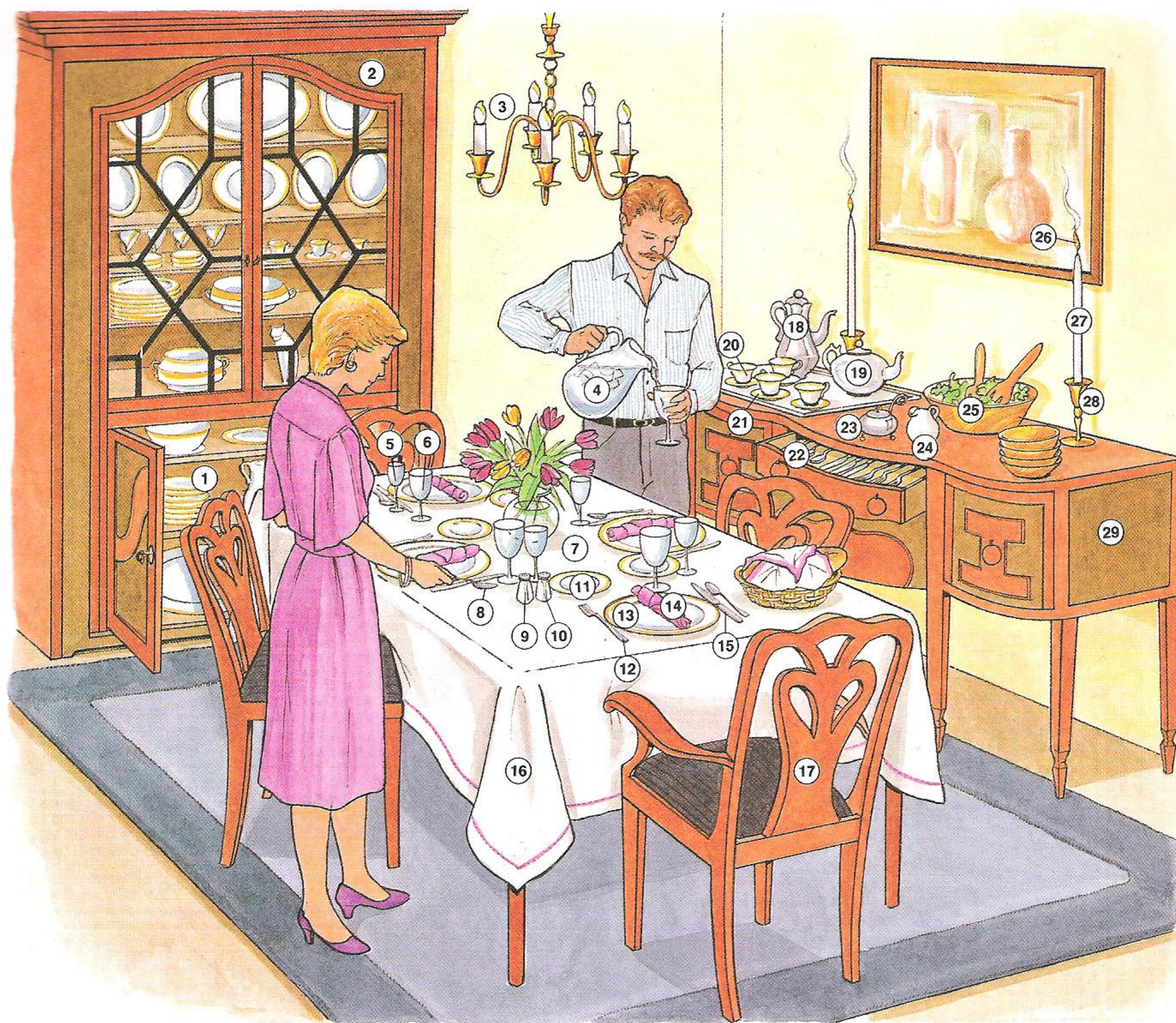

- 1. china
- 2. china closet
- 3. chandelier
- 4. pitcher
- 5. wine glass
- 6. water glass
- 7. table
- 8. spoon
- 9. pepper shaker
- 10. salt shaker

- 11. bread and butter plate
- 12. fork
- 13. plate
- 14. napkin
- 15. knife
- 16. tablecloth
- 17. chair
- 18. coffeepot
- 19. teapot
- 20. cup

- 21. saucer
- 22. silverware
- 23. sugar bowl
- 24. creamer
- 25. salad bowl
- 26. flame
- 27. candle
- 28. candlestick
- 29. buffet

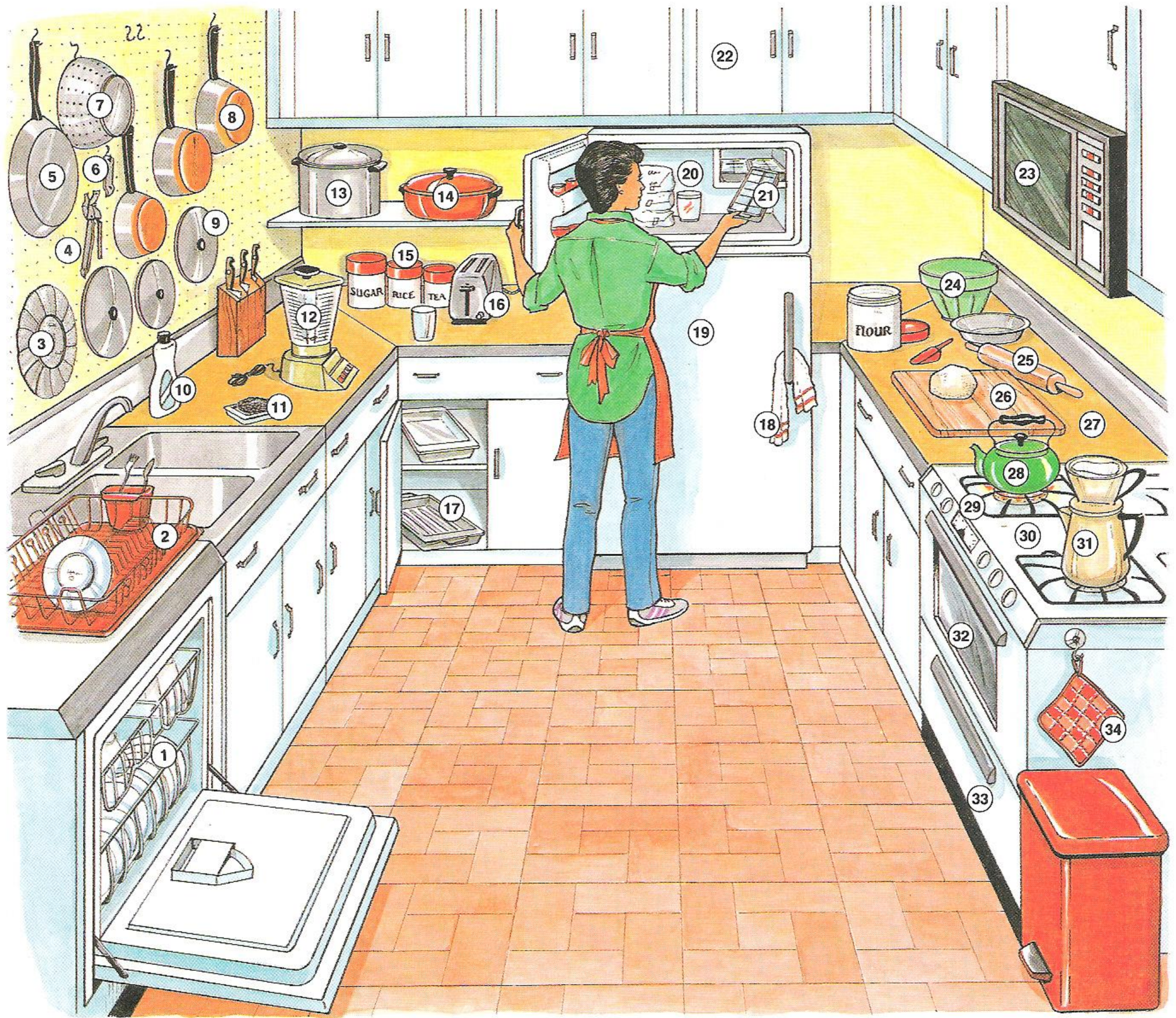

1. dishwasher
2. dish drainer
3. steamer
4. can opener
5. frying pan
6. bottle opener
7. colander
8. saucepan
9. lid
10. dishwashing liquid
11. scouring pad
12. blender

13. pot
14. casserole dish
15. canister
16. toaster
17. roasting pan
18. dish towel
19. refrigerator
20. freezer
21. ice tray
22. cabinet
23. microwave oven

24. mixing bowl
25. rolling pin
26. cutting board
27. counter
28. teakettle
29. burner
30. stove
31. coffeemaker
32. oven
33. broiler
34. pot holder



stir

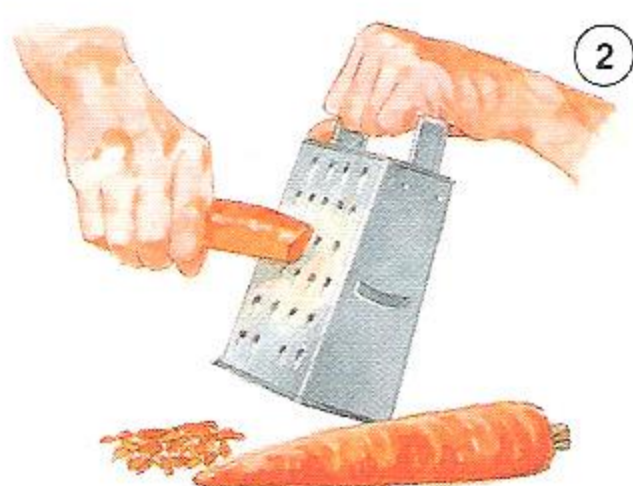

grate

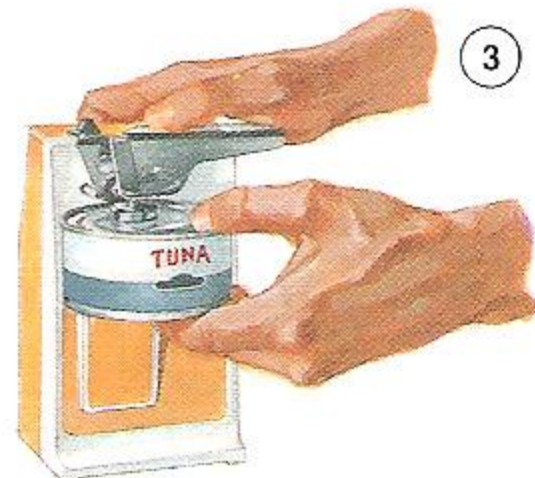

can opener



pour

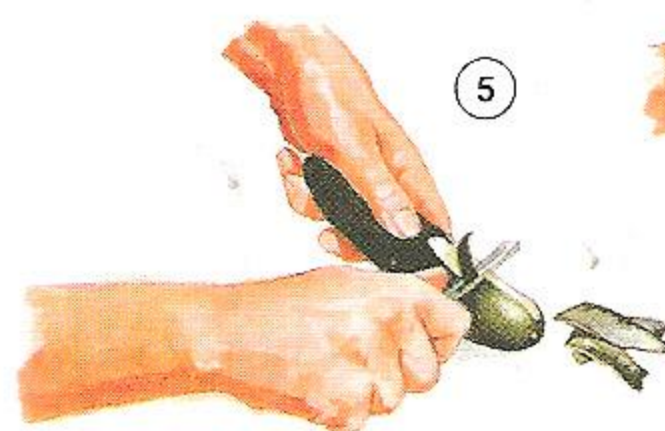

peel



carve



break

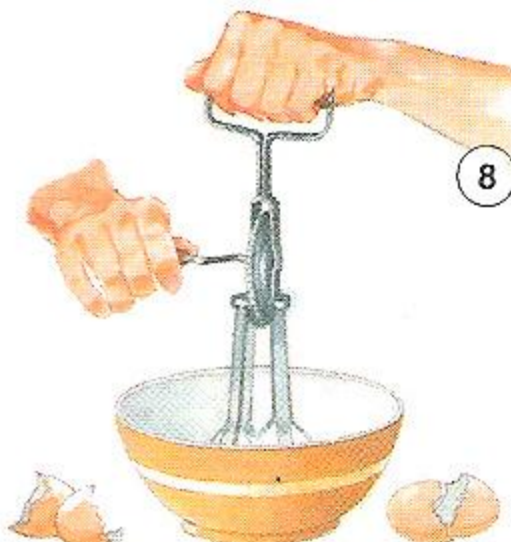

beat

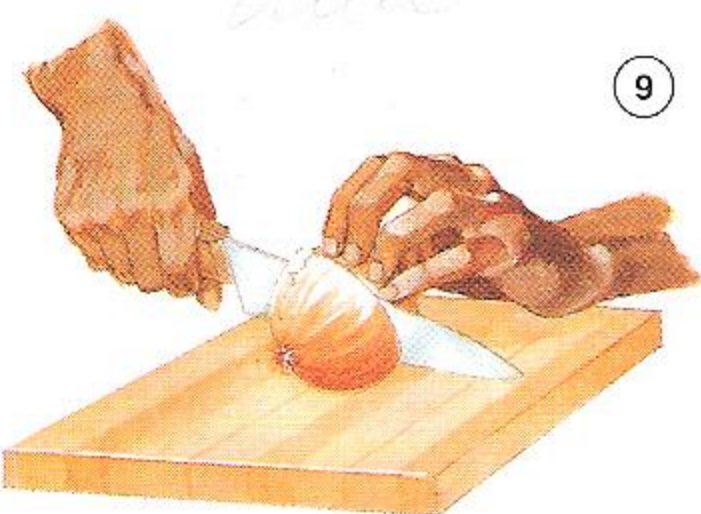

cut

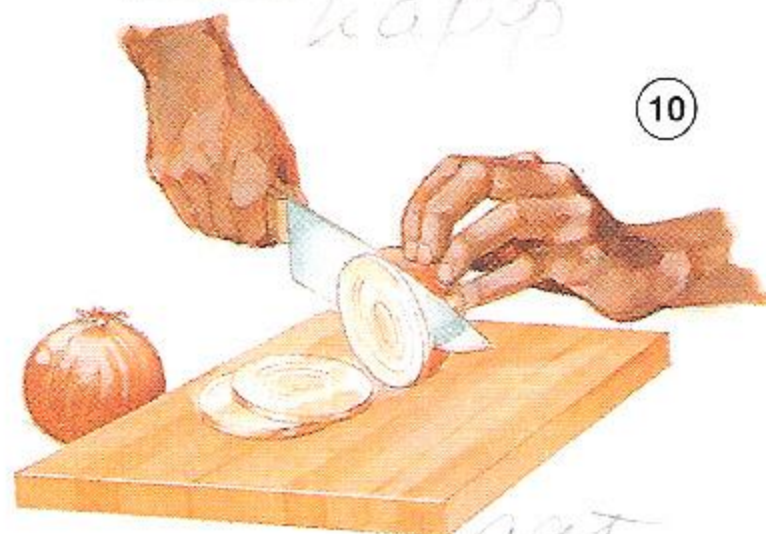

slice



chop

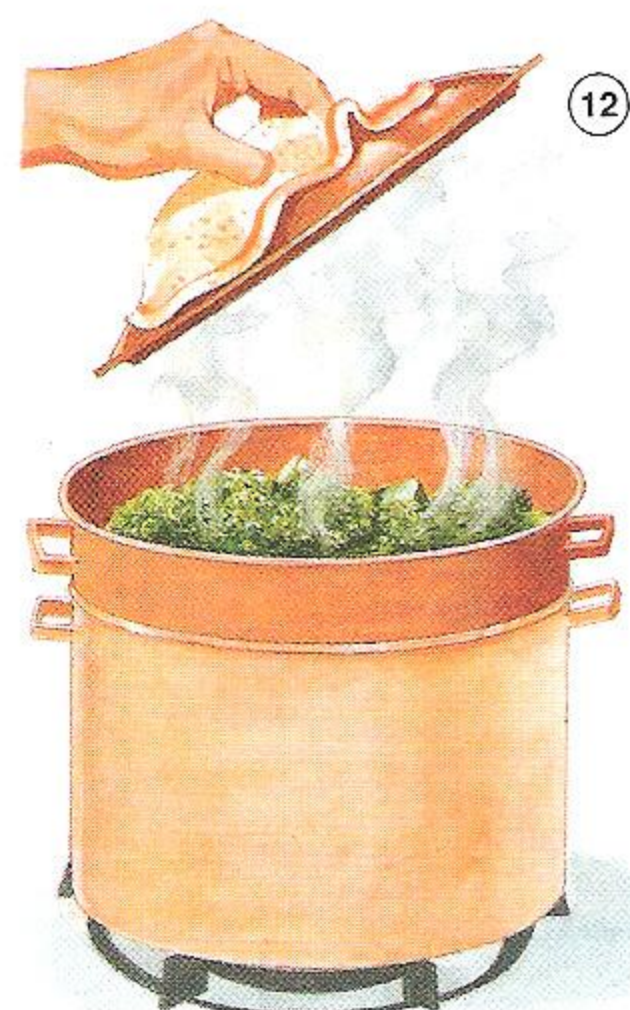

1. stir
2. grate
3. open
4. pour
5. peel
6. carve

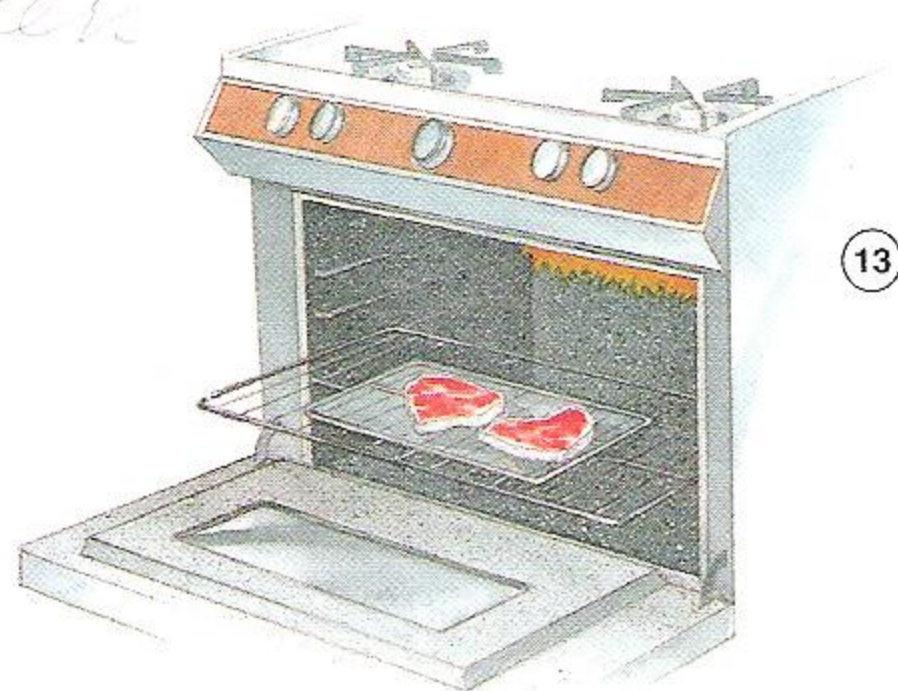

7. break
8. beat
9. cut
10. slice
11. chop

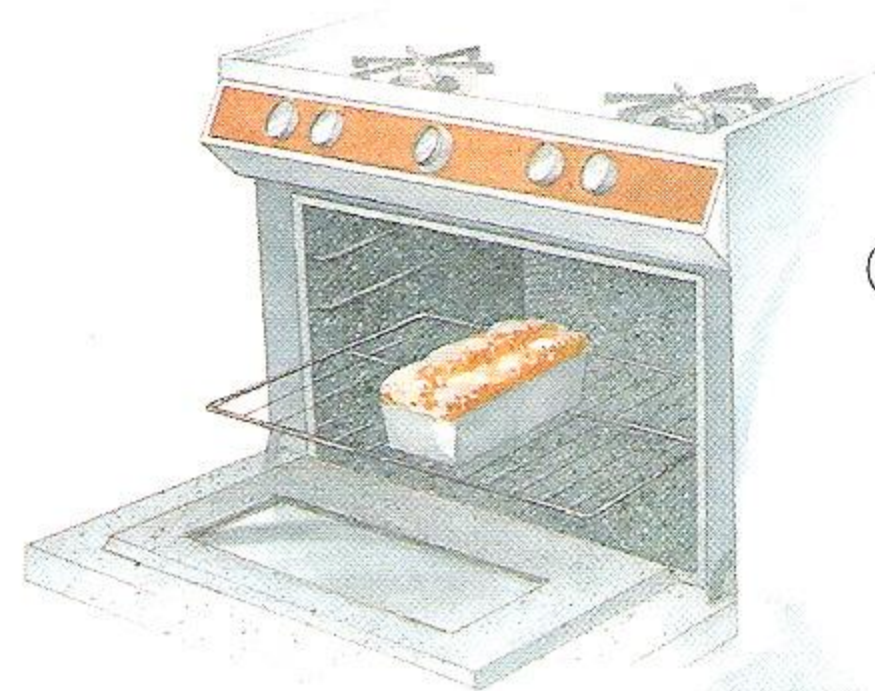

12. steam
13. broil
14. bake
15. fry
16. boil

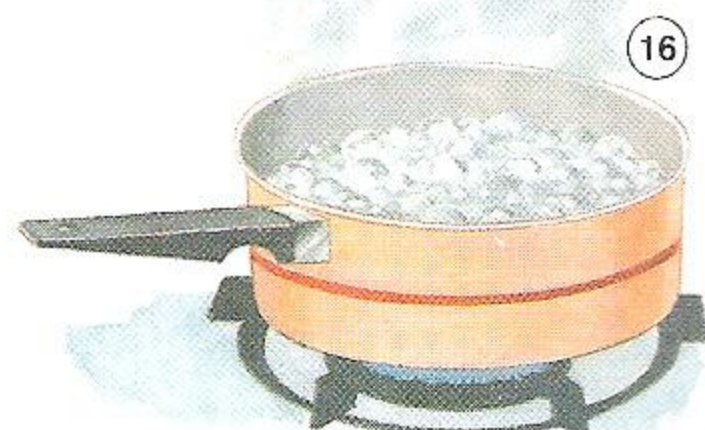

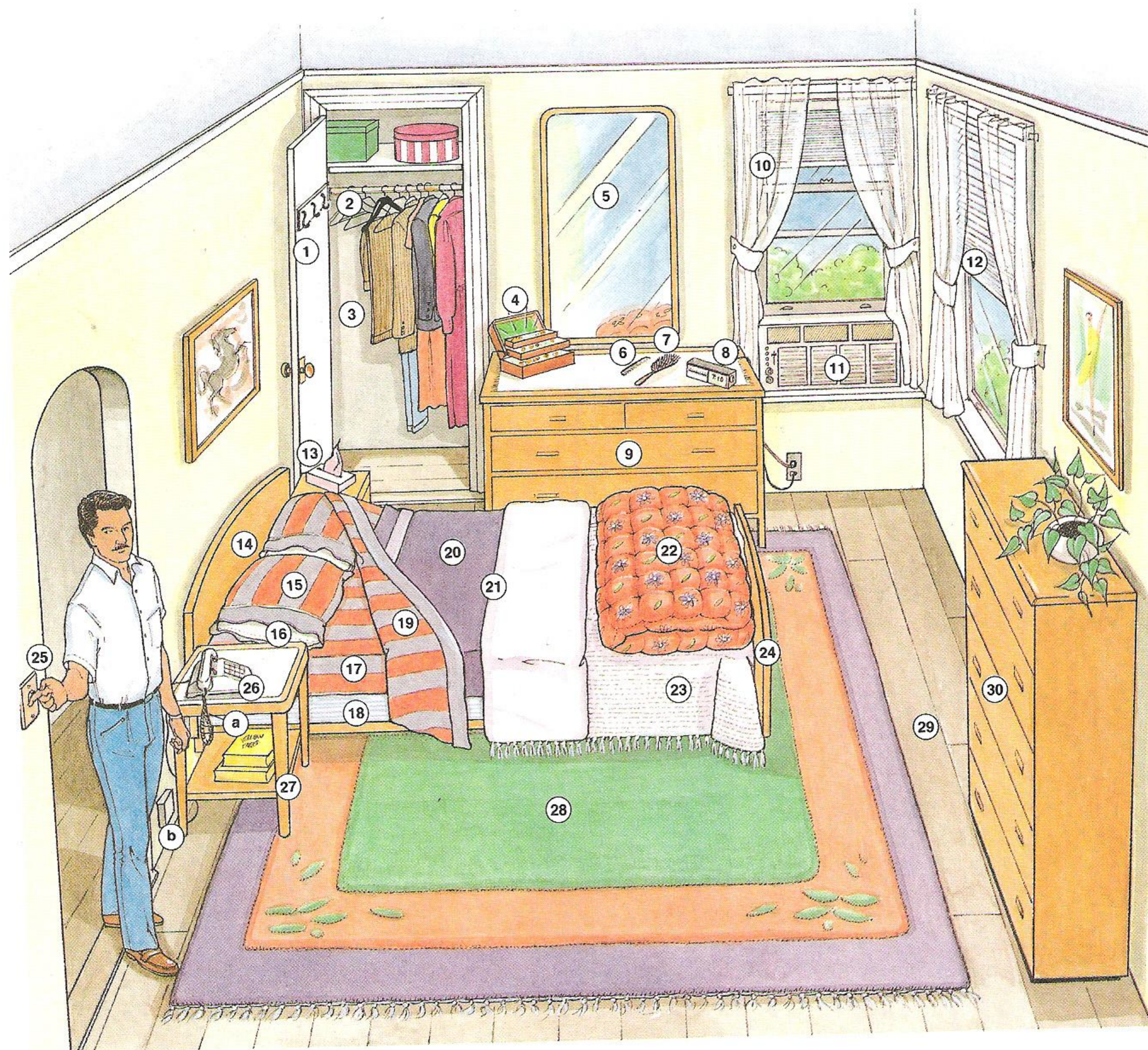

- 1. hook
- 2. hanger
- 3. closet
- 4. jewelry box
- 5. mirror
- 6. comb
- 7. hairbrush
- 8. alarm clock
- 9. bureau
- 10. curtain

- 11. air conditioner
- 12. blinds
- 13. tissues
- 14. headboard
- 15. pillowcase
- 16. pillow
- 17. mattress
- 18. box spring
- 19. (flat) sheet
- 20. blanket
- 21. bed
- 22. comforter

- 23. bedspread
- 24. footboard
- 25. light switch
- 26. phone
 - a. cord
 - b. jack
- 27. night table
- 28. rug
- 29. floor
- 30. chest of drawers



- | | | |
|-------------------|-----------------------|--------------------|
| 1. shade | 12. disposable diaper | 23. walker |
| 2. mobile | 13. cloth diaper | 24. swing |
| 3. teddy bear | 14. stroller | 25. doll house |
| 4. crib | 15. smoke detector | 26. cradle |
| 5. bumper | 16. rocking chair | 27. stuffed animal |
| 6. baby lotion | 17. bottle | 28. doll |
| 7. baby powder | 18. nipple | 29. toy chest |
| 8. baby wipes | 19. stretchie | 30. playpen |
| 9. changing table | 20. bib | 31. puzzle |
| 10. cotton swab | 21. rattle | 32. block |
| 11. safety pin | 22. pacifier | 33. potty |



1. curtain rod
2. curtain rings
3. shower cap
4. shower head
5. shower curtain
6. soap dish
7. sponge
8. shampoo
9. drain
10. stopper
11. bathtub

12. bath mat
13. wastepaper basket
14. medicine chest
15. soap
16. toothpaste
17. hot water faucet
18. cold water faucet
19. sink
20. nailbrush
21. toothbrush
22. washcloth

23. hand towel
24. bath towel
25. towel rack
26. hair dryer
27. tile
28. hamper
29. toilet
30. toilet paper
31. toilet brush
32. scale

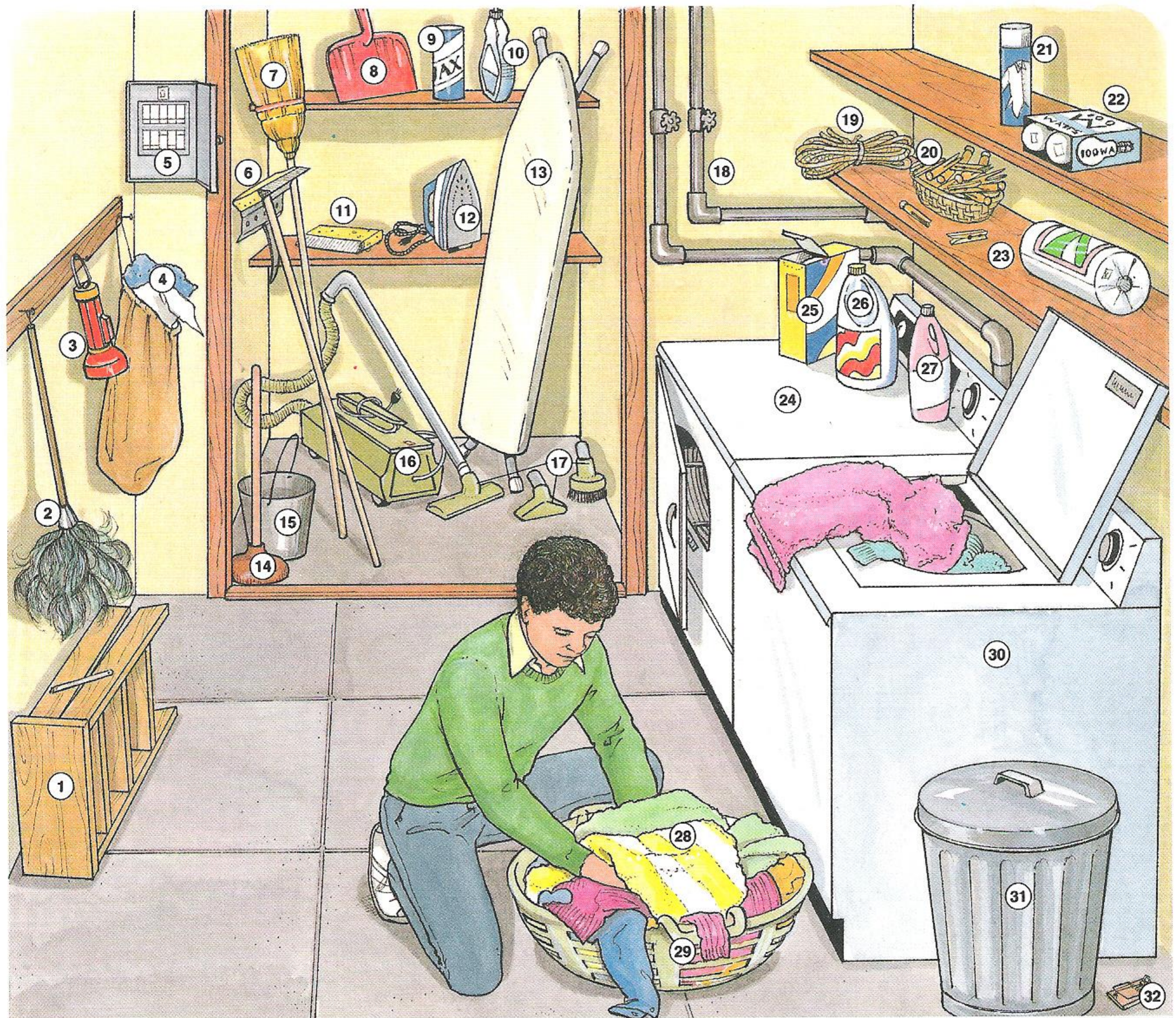

1. stepladder
2. feather duster
3. flashlight
4. rags
5. circuit breaker
6. (sponge) mop
7. broom
8. dustpan
9. cleanser
10. window cleaner
11. (mop) refill

12. iron
13. ironing board
14. plunger
15. bucket
16. vacuum cleaner
17. attachments
18. pipe
19. clothesline
20. clothespins
21. spray starch
22. lightbulb

23. paper towels
24. dryer
25. laundry detergent
26. bleach
27. fabric softener
28. laundry
29. laundry basket
30. washing machine
31. garbage can
32. mousetrap

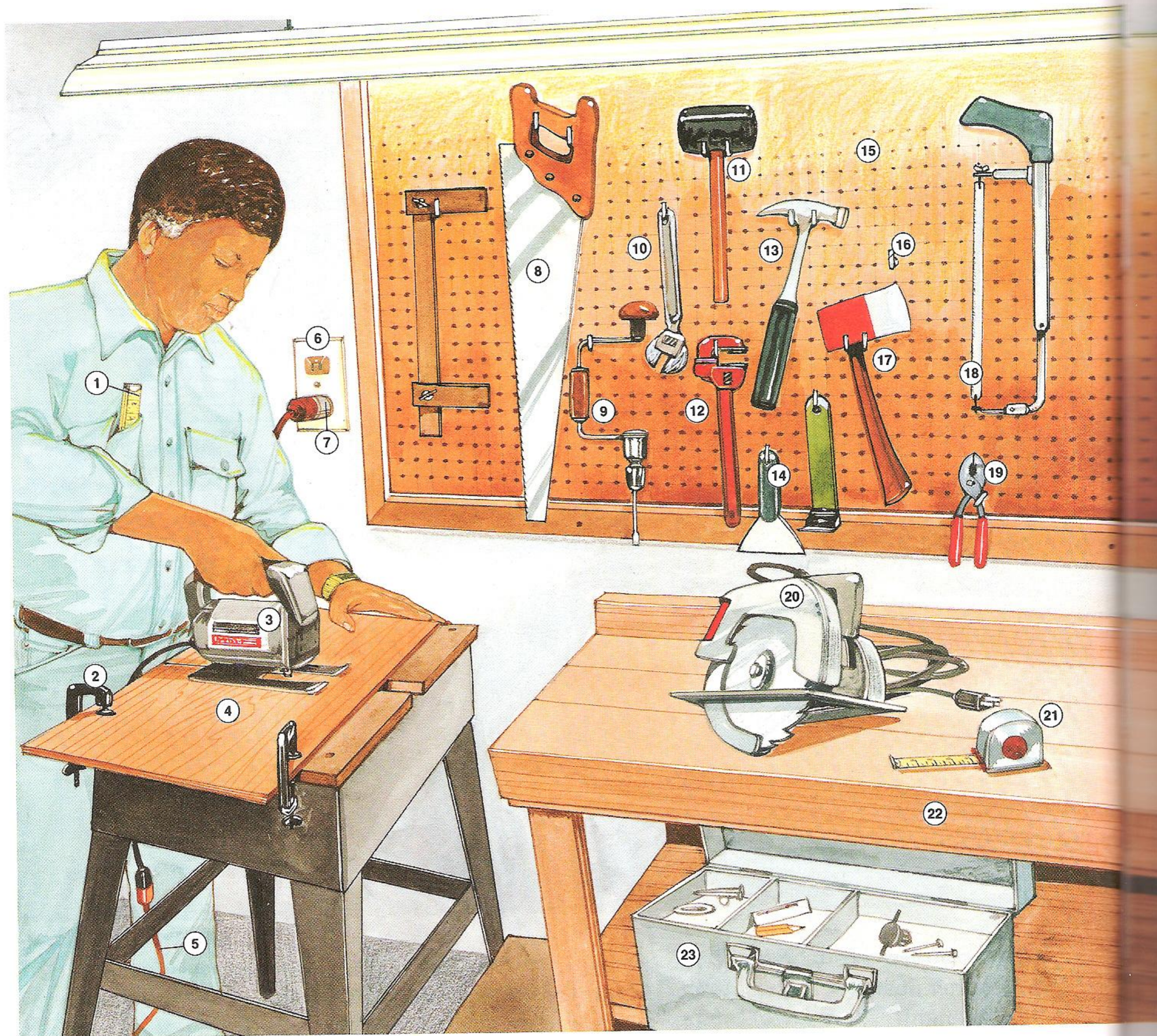

1. carpenter's rule
2. C-clamp
3. jigsaw
4. wood
5. extension cord
6. outlet
7. grounding plug
8. saw

9. brace
10. wrench
11. mallet
12. monkey wrench
13. hammer
14. scraper
15. pegboard
16. hook

17. hatchet
18. hacksaw
19. pliers
20. circular saw
21. tape measure
22. workbench
23. toolbox

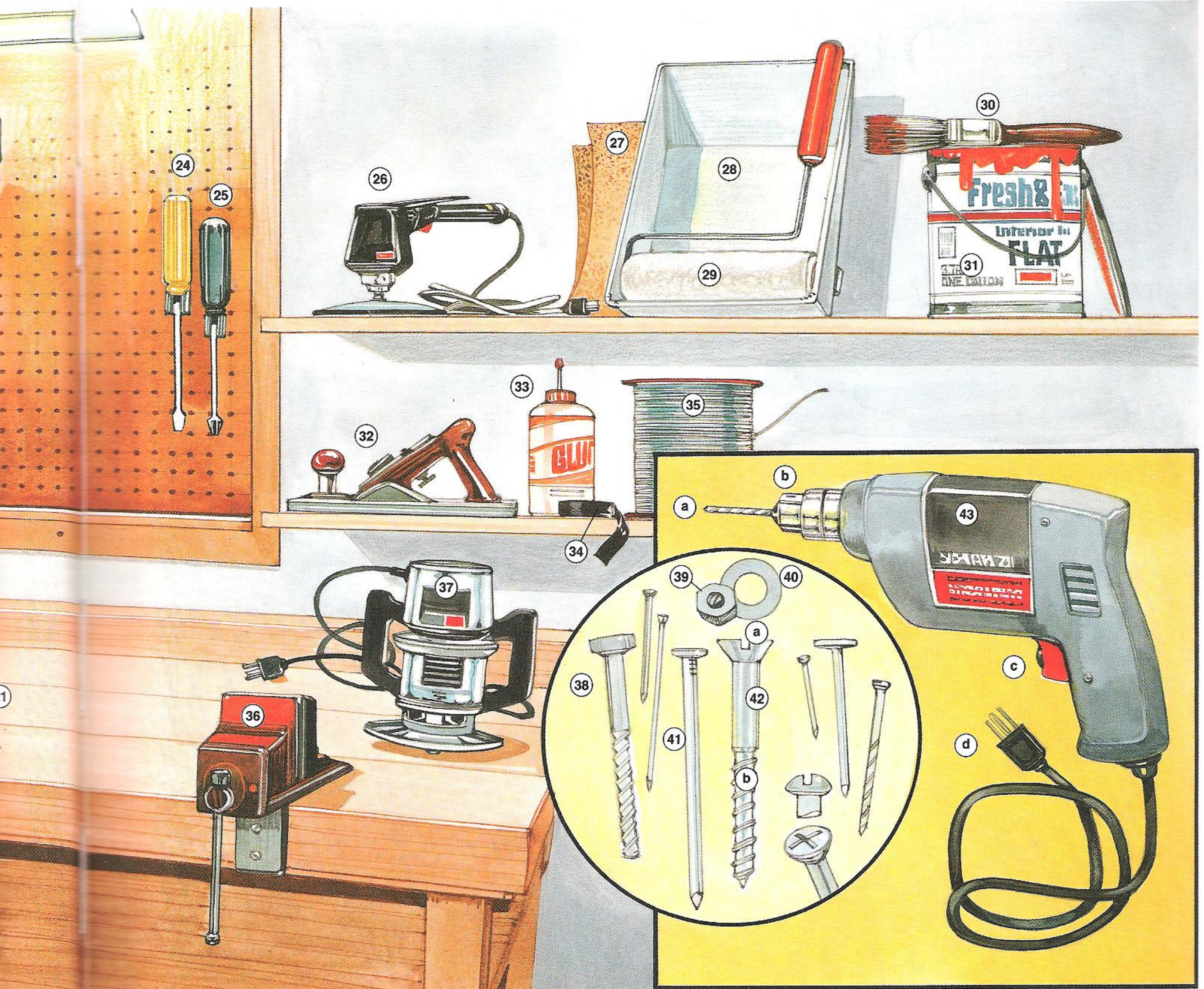

- 24. screwdriver
- 25. Phillips screwdriver
- 26. power sander
- 27. sandpaper
- 28. pan
- 29. roller
- 30. paintbrush
- 31. paint
- 32. wood plane

- 33. glue
- 34. electrical tape
- 35. wire
- 36. vise
- 37. router
- 38. bolt
- 39. nut
- 40. washer
- 41. nail

- 42. screw
 - a. head
 - b. thread
- 43. electric drill
 - a. bit
 - b. shank
 - c. switch
 - d. plug



1



2



3

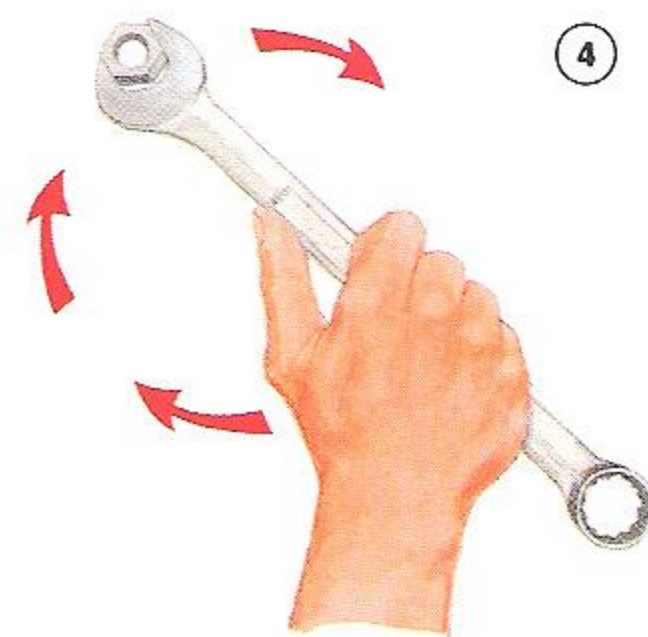

4

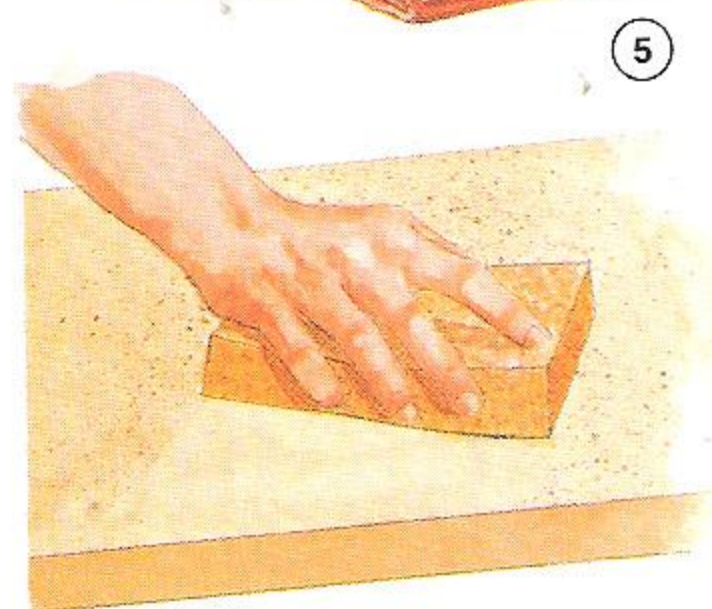

5



6

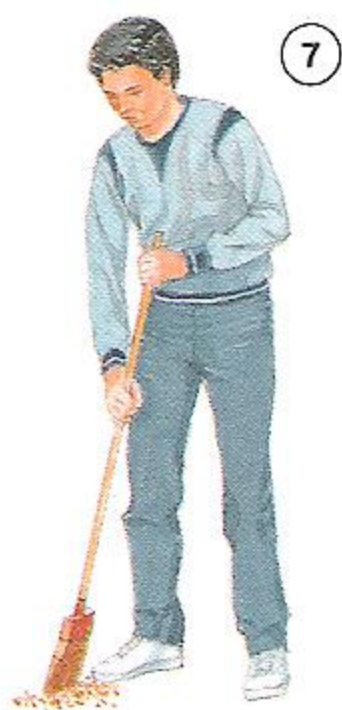

7



8



9

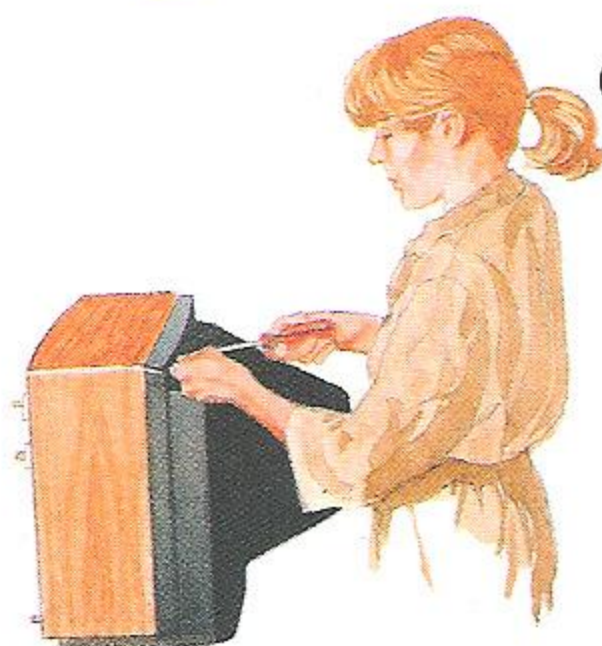

10



11

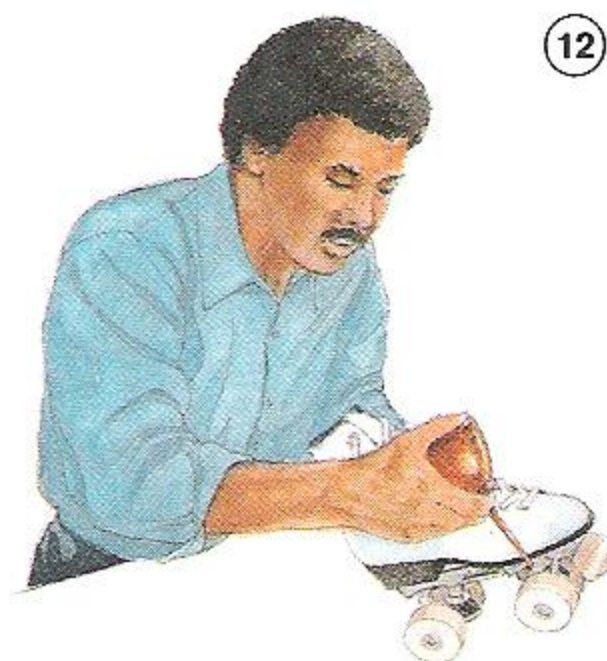

12



13



14



15

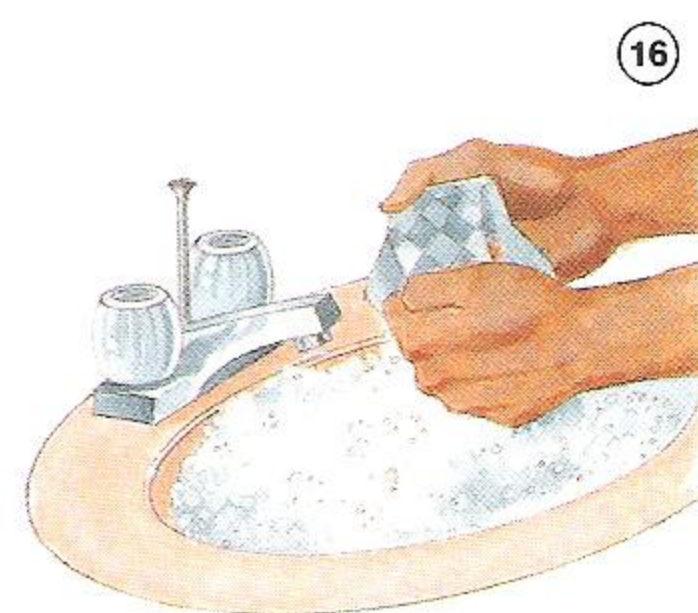

16

1. fold
2. scrub
3. polish
4. tighten
5. wipe
6. hang

7. sweep
8. make (the bed)
9. dry
10. repair
11. iron

12. oil
13. change (the sheets)
14. vacuum
15. dust
16. wash

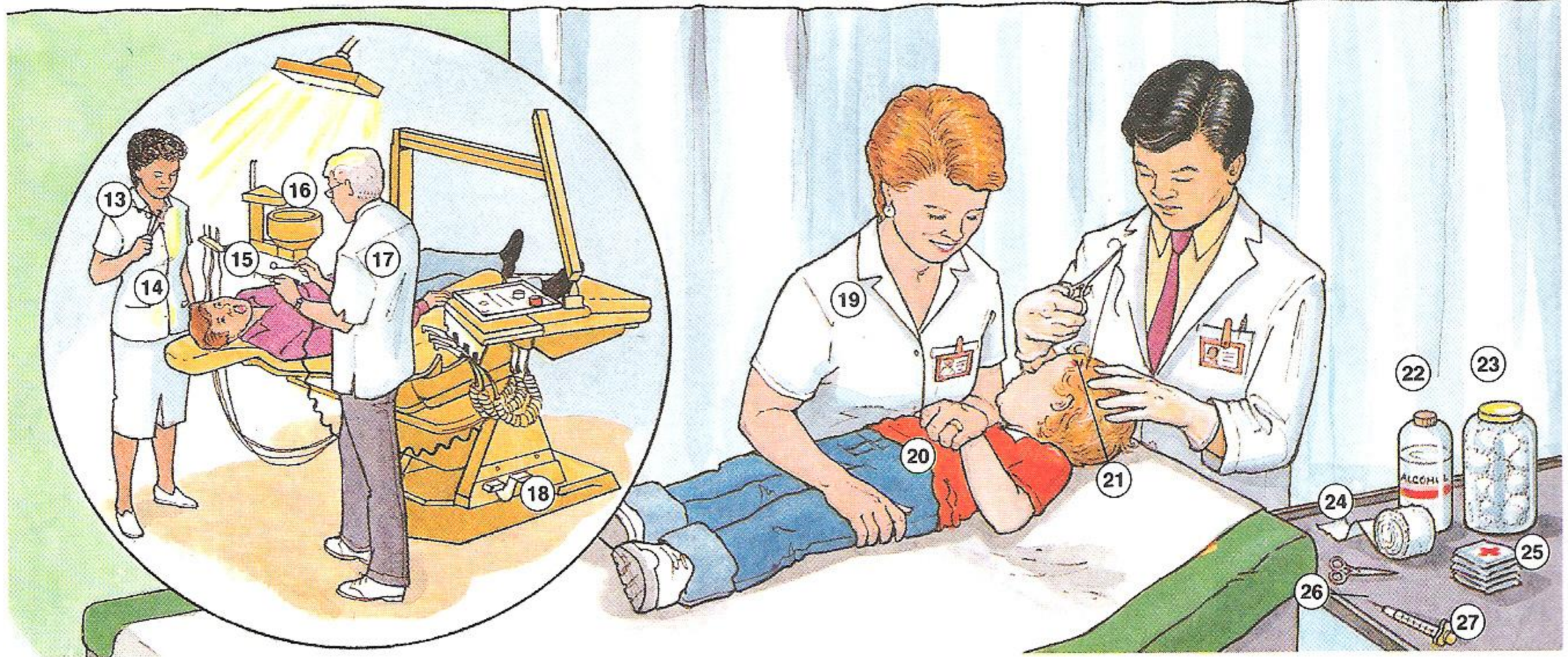
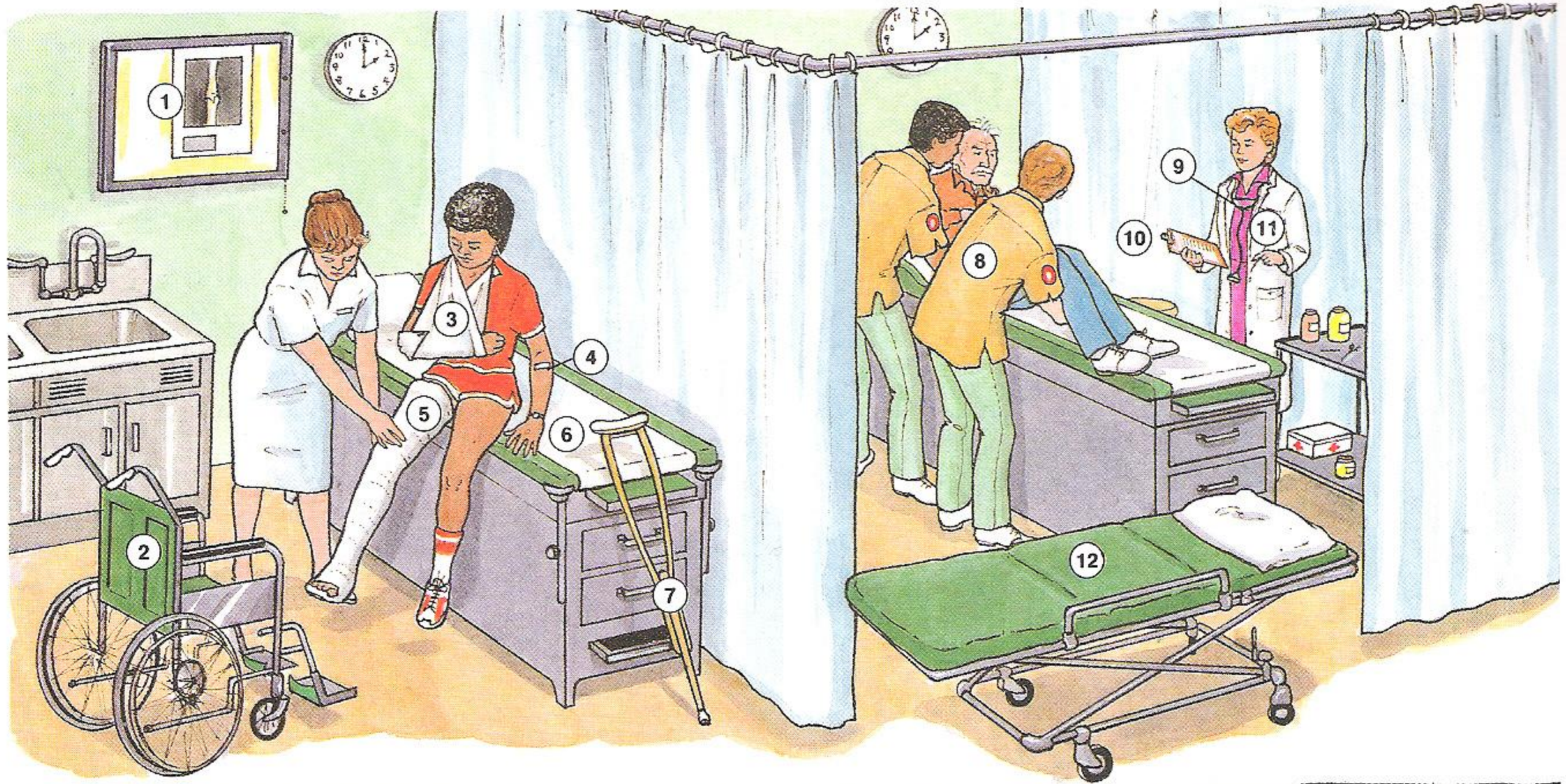

1. X ray
2. wheelchair
3. sling
4. Band-Aid
5. cast
6. examining table
7. crutch
8. attendant
9. stethoscope

10. chart
11. doctor
12. stretcher
13. instruments
14. oral hygienist
15. drill
16. basin
17. dentist
18. pedal

19. nurse
20. patient
21. stitches
22. alcohol
23. cotton balls
24. (gauze) bandage
25. gauze pads
26. needle
27. syringe

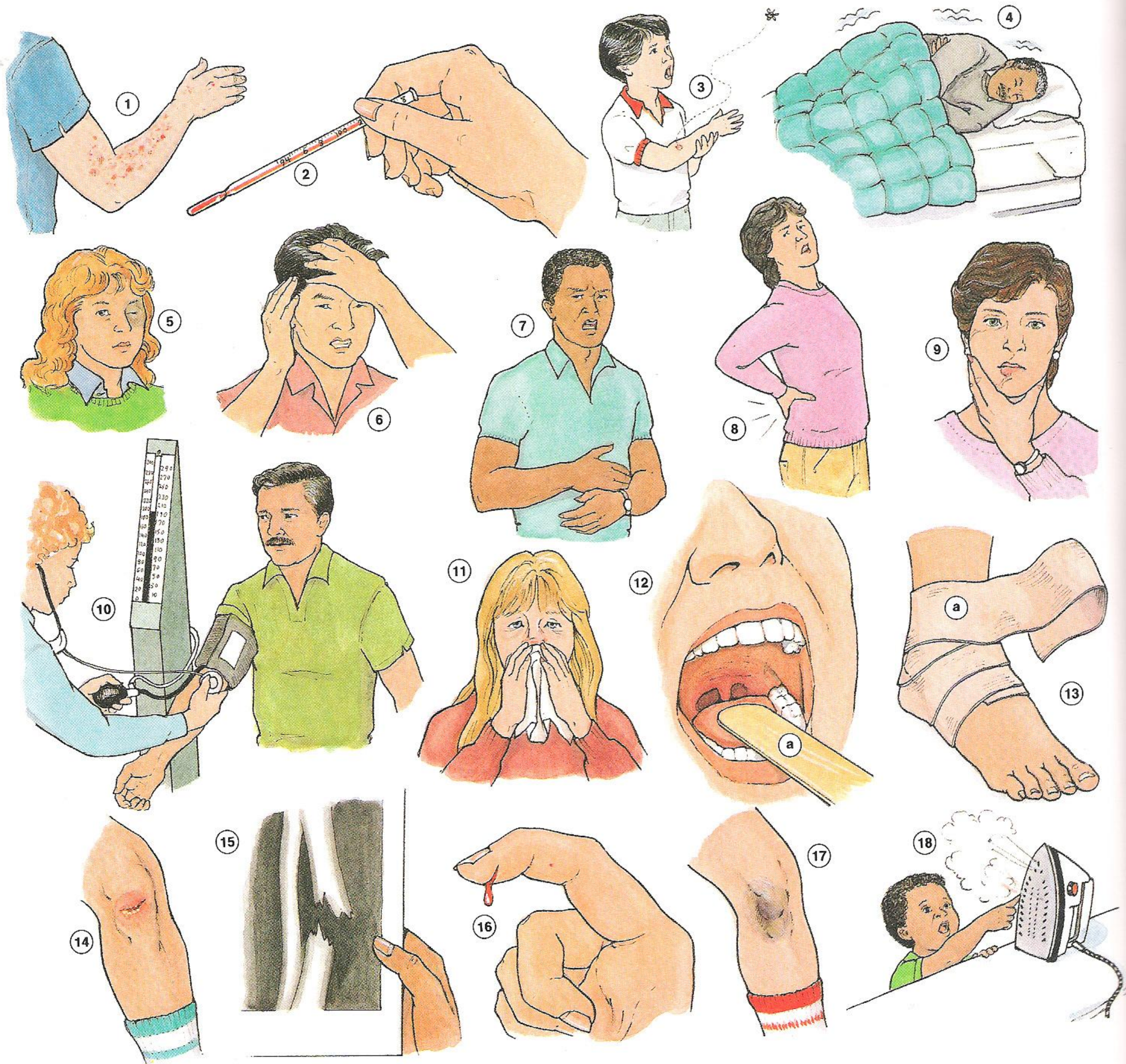

- 1. rash
- 2. fever
- 3. insect bite
- 4. chills
- 5. black eye
- 6. headache

- 7. stomachache
- 8. backache
- 9. toothache
- 10. high blood pressure
- 11. cold
- 12. sore throat
- a. tongue depressor

- 13. sprain
- a. stretch bandage
- 14. infection
- 15. broken bone
- 16. cut
- 17. bruise
- 18. burn

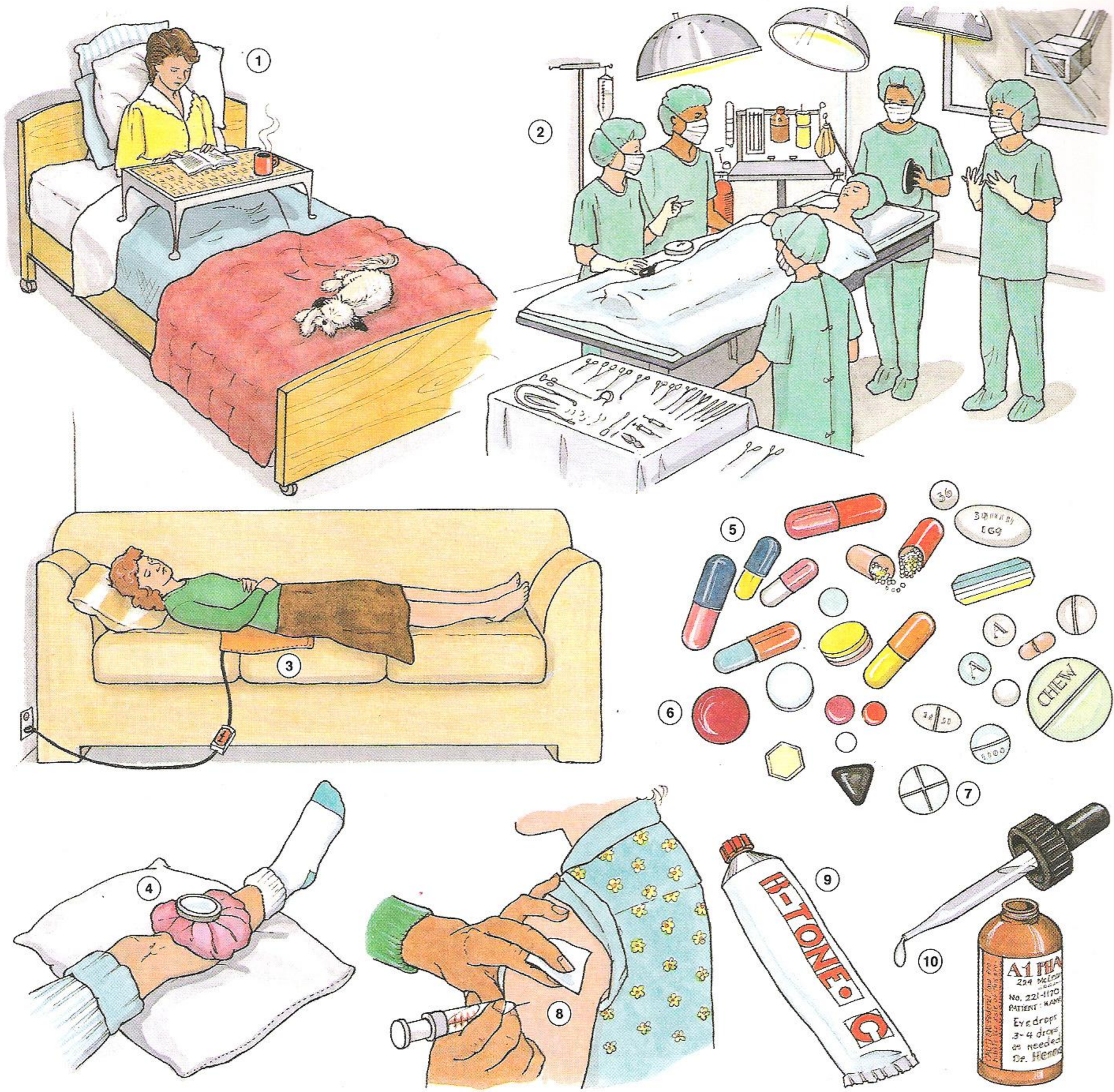

1. bed rest
2. surgery
3. heating pad
4. ice pack

- Medicine**
5. capsule
 6. tablet
 7. pill
 8. injection
 9. ointment
 10. eye drops



- 1. ladder
- 2. fire engine
- 3. fire truck
- 4. fire escape
- 5. fire
- 6. ambulance

- 7. paramedic
- 8. hose
- 9. fire hydrant
- 10. fire fighter
- 11. fire extinguisher
- 12. helmet

- 13. coat
- 14. axe
- 15. smoke
- 16. water
- 17. nozzle

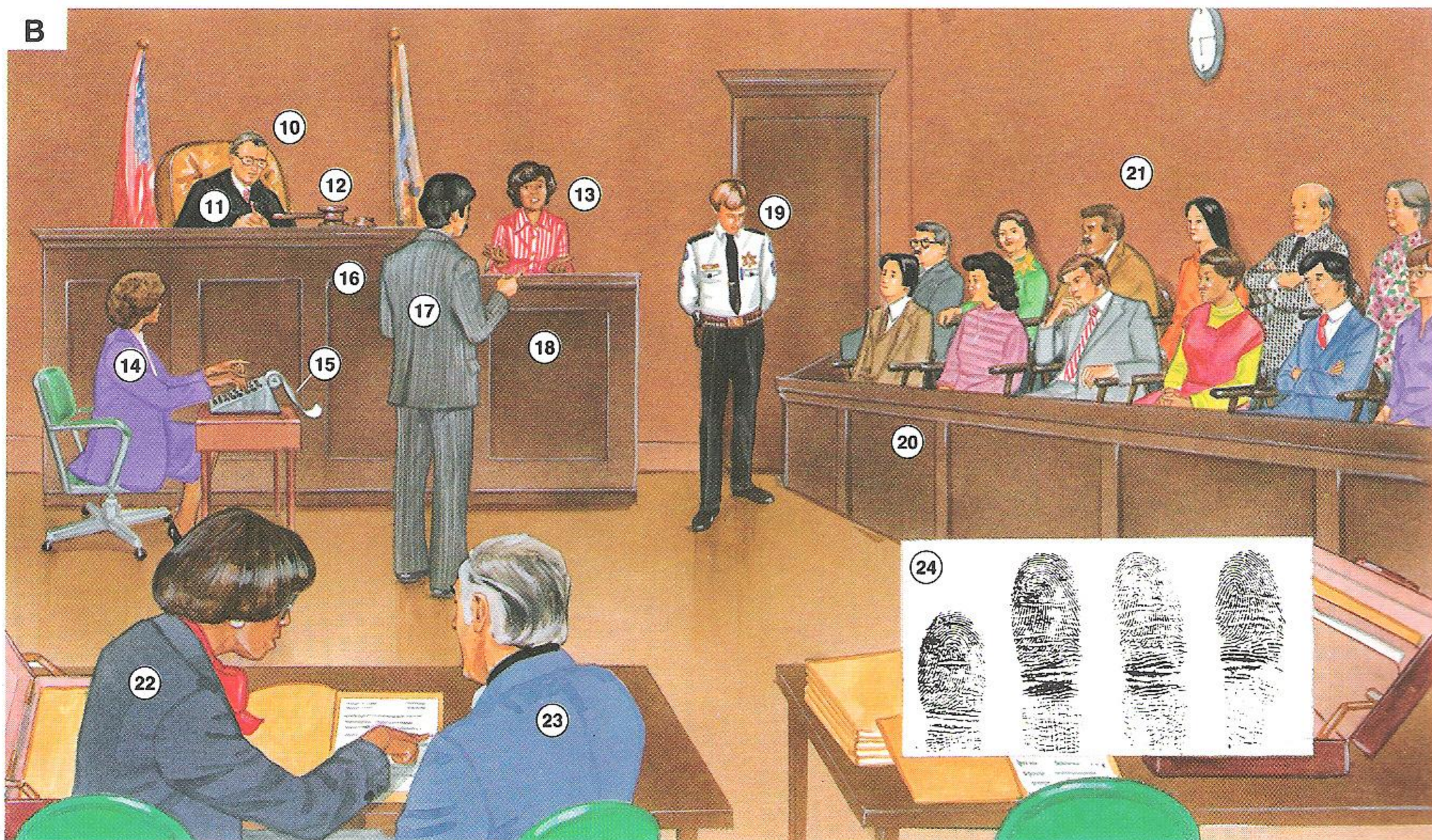
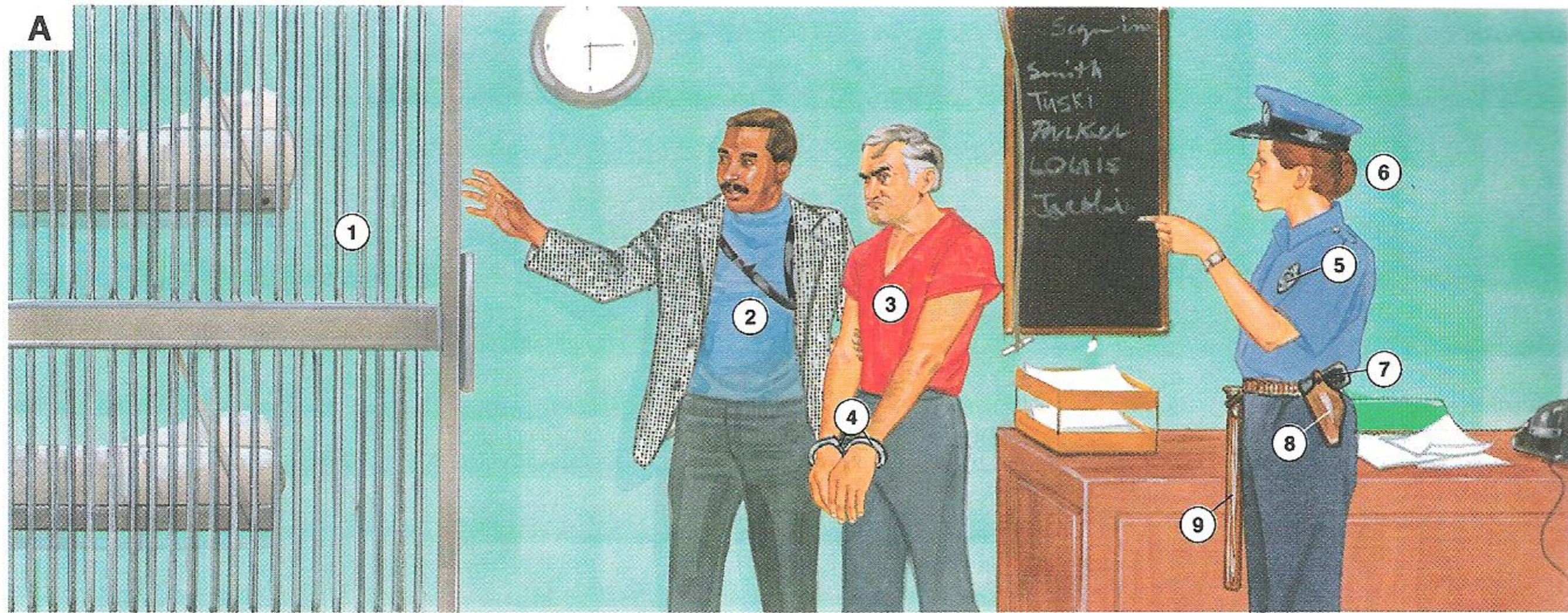

A. Police Station

- 1. jail
- 2. detective
- 3. suspect
- 4. handcuffs
- 5. badge
- 6. police officer
- 7. gun
- 8. holster

9. nightstick

B. Court

- 10. judge
- 11. robes
- 12. gavel
- 13. witness
- 14. court reporter
- 15. transcript

- 16. bench
- 17. prosecuting attorney
- 18. witness stand
- 19. court officer
- 20. jury box
- 21. jury
- 22. defense attorney
- 23. defendant
- 24. fingerprints

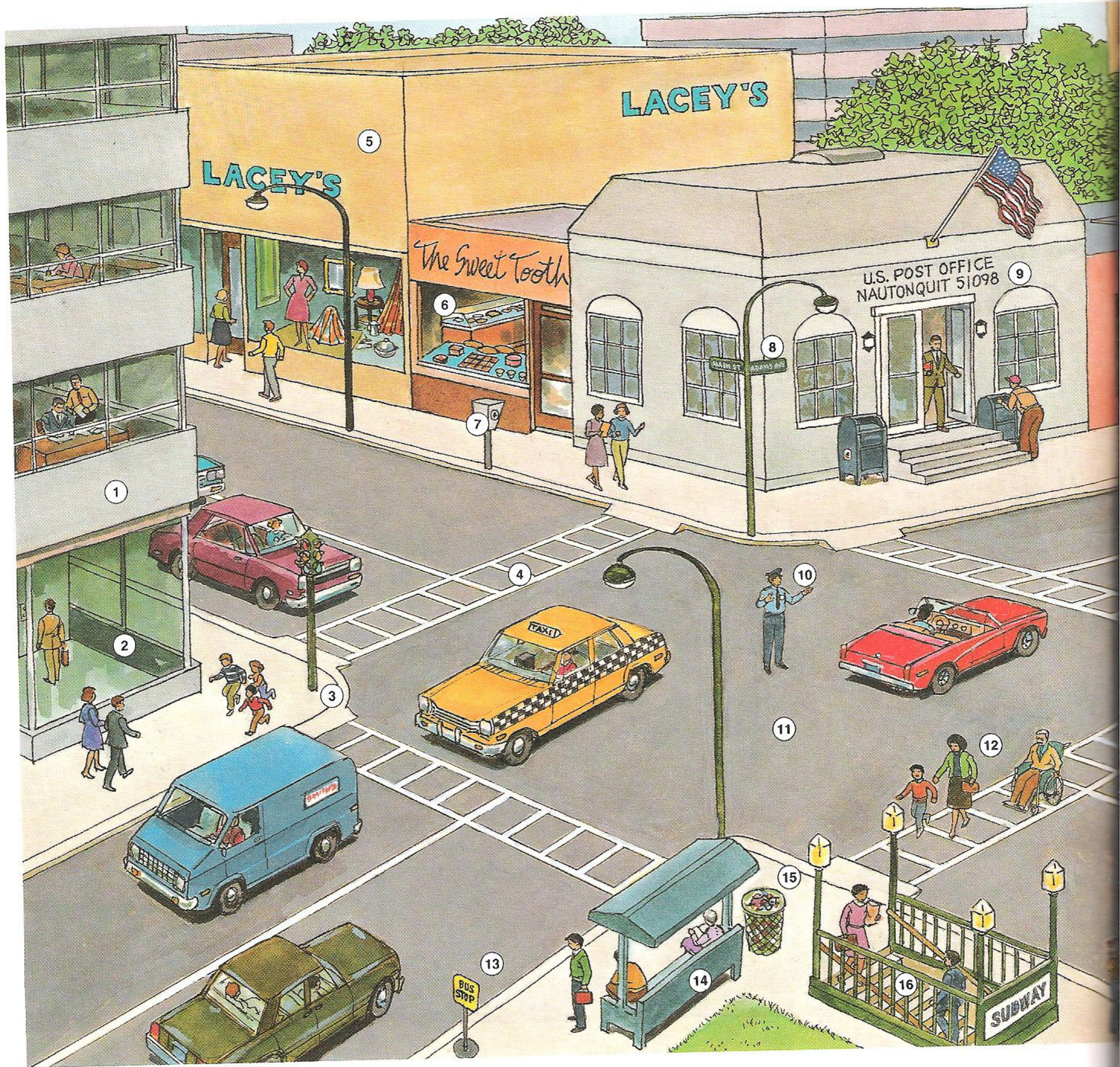

- 1. office building
- 2. lobby
- 3. corner
- 4. crosswalk
- 5. department store
- 6. bakery

- 7. public telephone
- 8. street sign
- 9. post office
- 10. traffic cop
- 11. intersection

- 12. pedestrian
- 13. bus stop
- 14. bench
- 15. trash basket
- 16. subway station

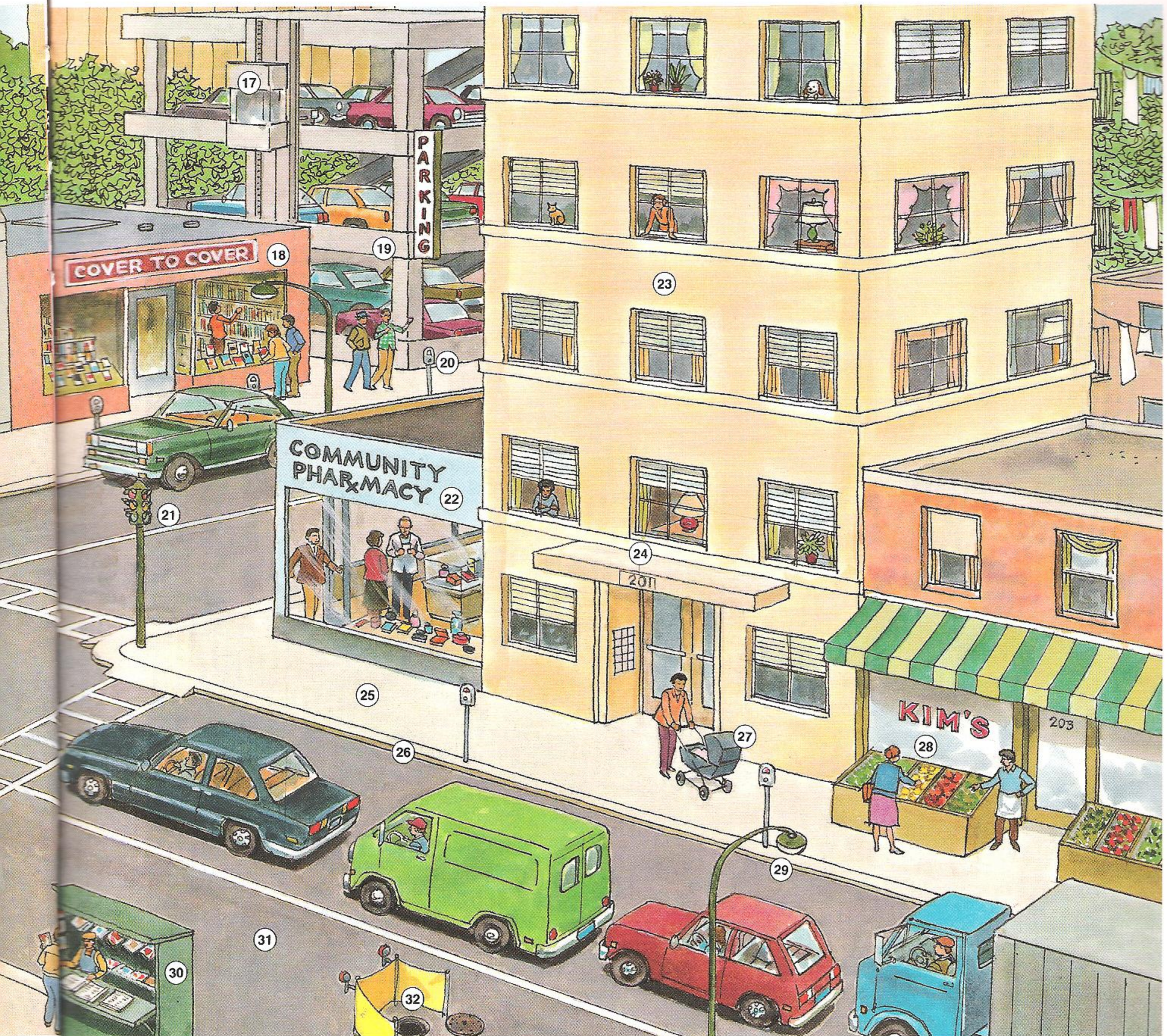

- 17. elevator
- 18. bookstore
- 19. parking garage
- 20. parking meter
- 21. traffic light
- 22. drugstore

- 23. apartment house
- 24. building number
- 25. sidewalk
- 26. curb
- 27. baby carriage

- 28. fruit and vegetable market
- 29. streetlight
- 30. newsstand
- 31. street
- 32. manhole



A. Delivering Mail

- 1. mailbox
- 2. mail
- 3. letter carrier
- 4. mailbag
- 5. mail truck
- 6. U.S. mailbox
- 7. letter
- 8. return address

- 9. postmark
- 10. stamp
- 11. address
- 12. zip code

B. The Post Office

- 13. mail slot
- 14. postal worker
- 15. window

C. Types of Mail

- 16. (airmail) envelope
- 17. postcard
- 18. money order
- 19. package
- 20. string
- 21. label
- 22. tape
- 23. Express Mail (package)



- | | | |
|------------------|-------------------------|---------------------------|
| 1. library clerk | 10. subject | 19. globe |
| 2. checkout desk | 11. row | 20. atlas |
| 3. library card | 12. call slip | 21. reference section |
| 4. card catalog | 13. microfilm | 22. information desk |
| 5. drawer | 14. microfilm reader | 23. (reference) librarian |
| 6. call card | 15. periodicals section | 24. dictionary |
| 7. call number | 16. magazine | 25. encyclopedia |
| 8. author | 17. rack | 26. shelf |
| 9. title | 18. photocopier | |

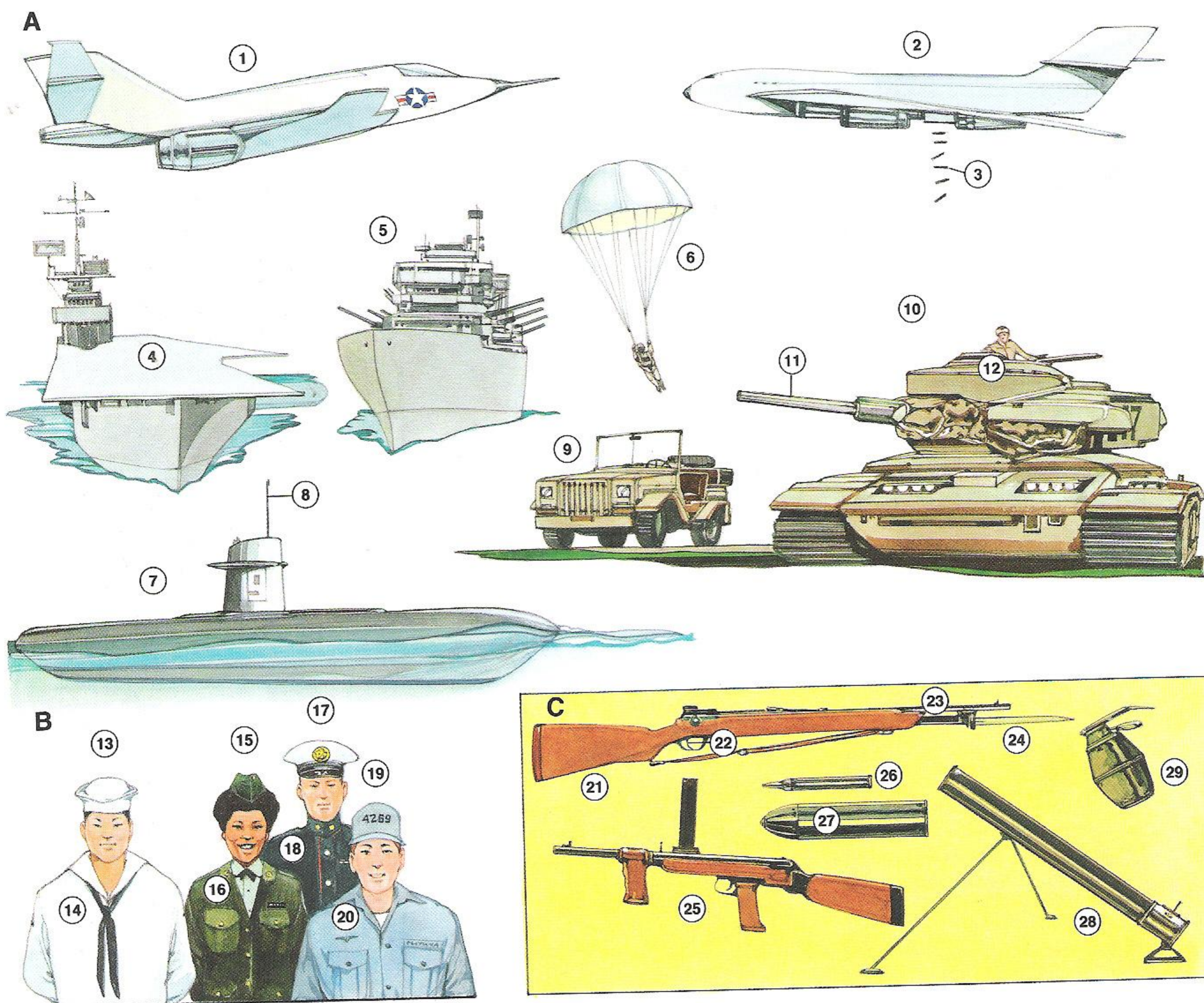

A. Vehicles and Equipment

- 1. fighter plane
- 2. bomber
- 3. bomb
- 4. aircraft carrier
- 5. battleship
- 6. parachute
- 7. submarine
- 8. periscope
- 9. jeep
- 10. tank
- 11. cannon
- 12. gun turret

B. Personnel

- 13. Navy
- 14. sailor
- 15. Army
- 16. soldier
- 17. Marines
- 18. marine
- 19. Air Force
- 20. airman

C. Weapons and Ammunition

- 21. rifle
- 22. trigger
- 23. barrel
- 24. bayonet
- 25. machine gun
- 26. bullet
- 27. shell
- 28. mortar
- 29. hand grenade



1. street cleaner
2. tow truck
3. fuel truck
4. pickup truck
5. snow plow
6. garbage truck

7. sanitation worker
8. lunch truck
9. panel truck
10. delivery person
11. moving van
12. mover

13. cement truck
14. dump truck
15. tractor trailer
16. truck driver
17. transporter
18. flatbed

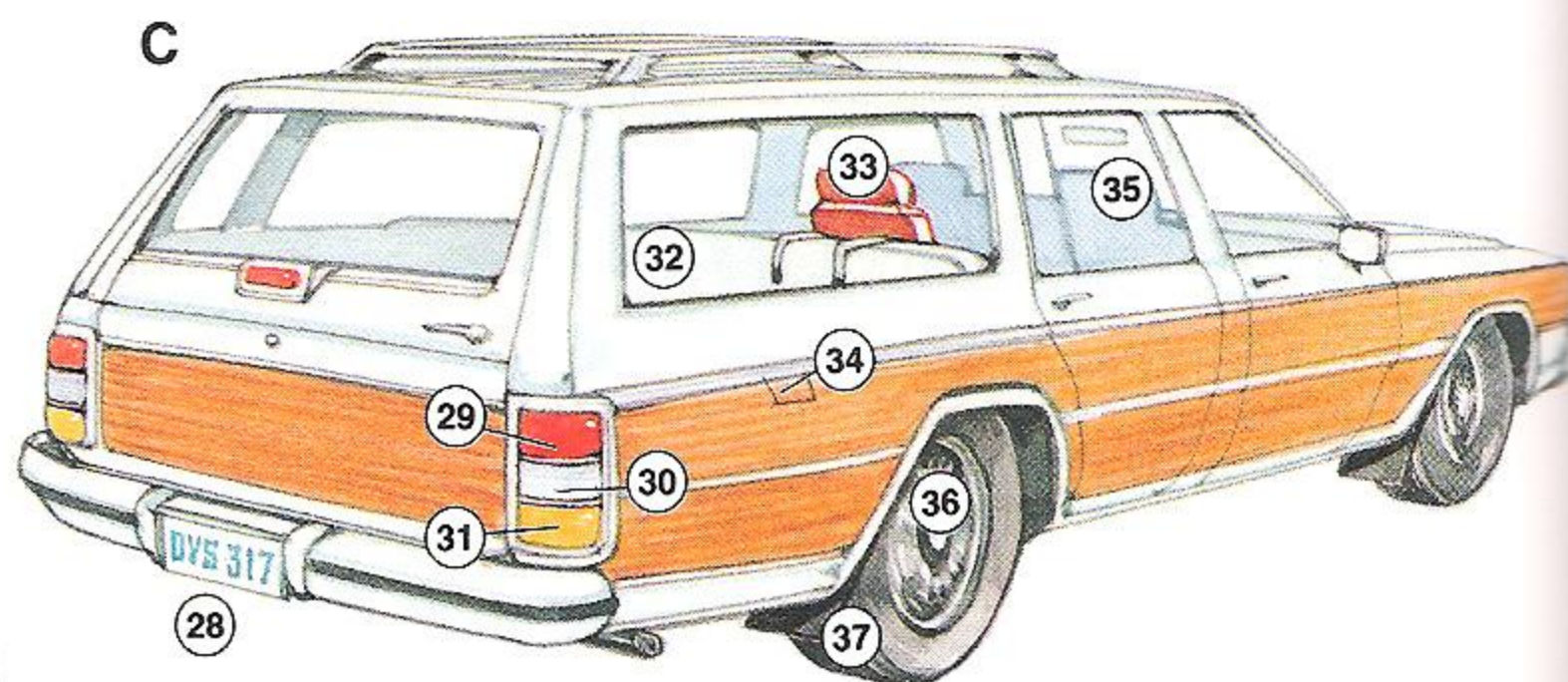
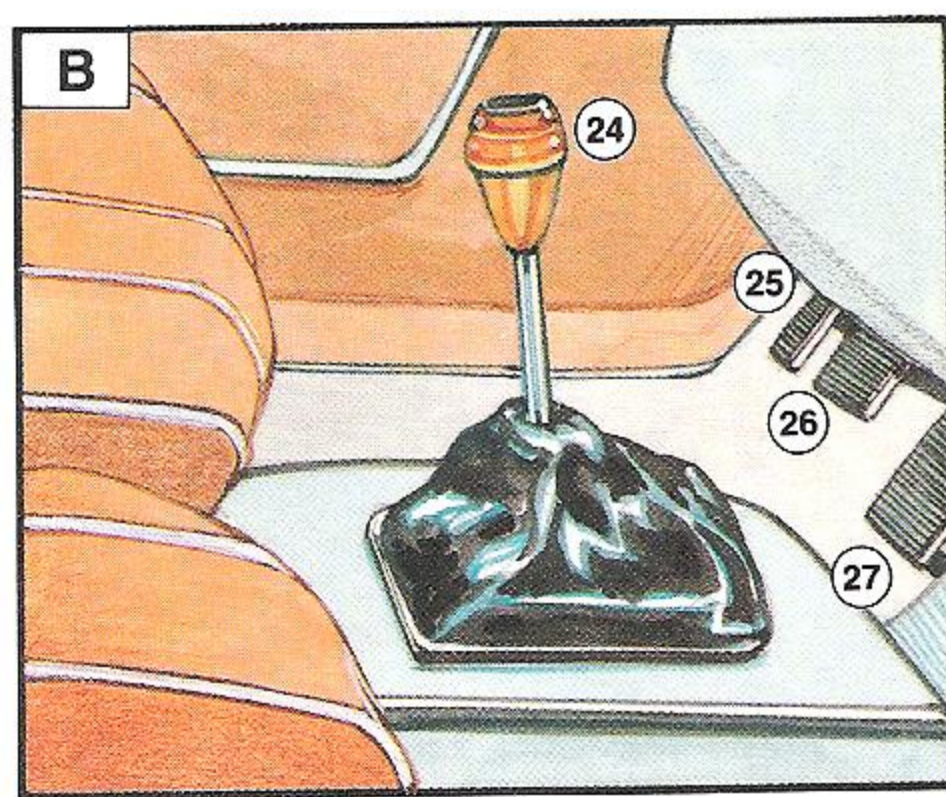
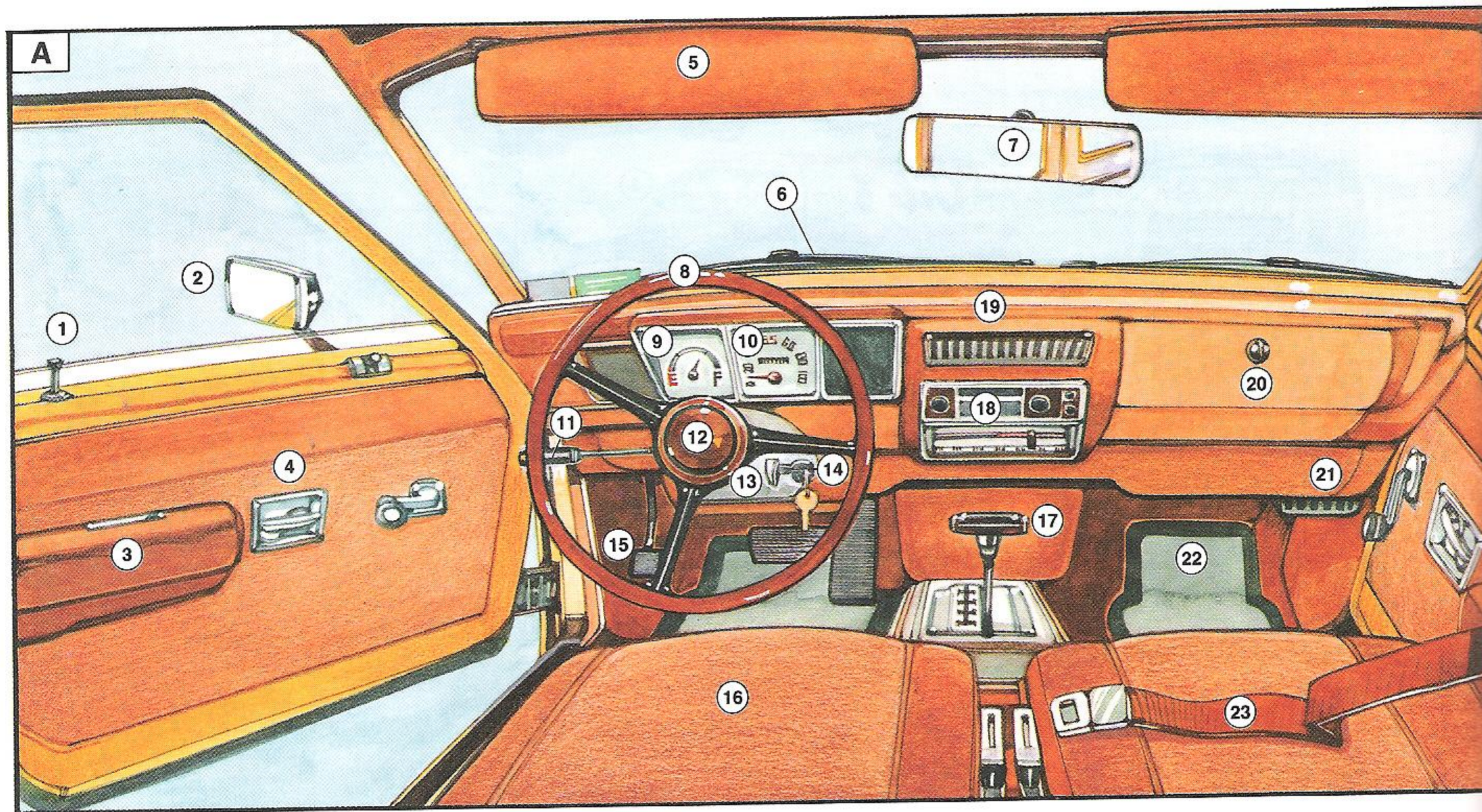

A. Automatic Transmission

- 1. door lock
- 2. side mirror
- 3. armrest
- 4. door handle
- 5. visor
- 6. windshield wiper
- 7. rearview mirror
- 8. steering wheel
- 9. gas gauge
- 10. speedometer
- 11. turn signal lever
- 12. horn
- 13. column

- 14. ignition
- 15. emergency brake
- 16. bucket seat
- 17. gearshift
- 18. radio
- 19. dashboard
- 20. glove compartment
- 21. vent
- 22. mat
- 23. seat belt

B. Manual Transmission

- 24. stick shift
- 25. clutch

- 26. brake
- 27. accelerator

C. Station Wagon

- 28. license plate
- 29. brake light
- 30. backup light
- 31. taillight
- 32. backseat
- 33. child's seat
- 34. gas tank
- 35. headrest
- 36. hubcap
- 37. tire

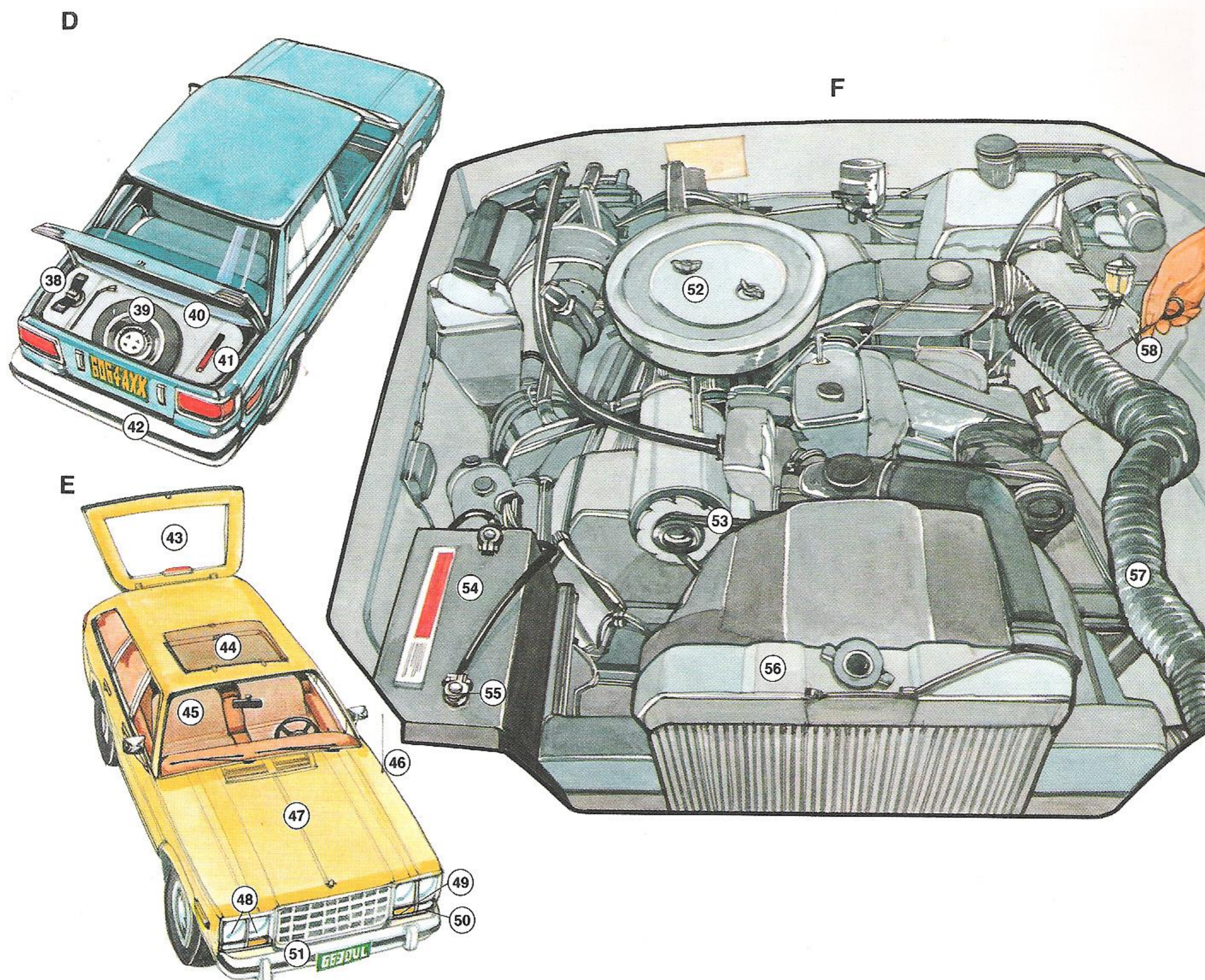
**D. (Two-door) Sedan**

- 38. jack
- 39. spare tire
- 40. trunk
- 41. flare
- 42. rear bumper

E. Four-door Hatchback

- 43. hatchback
- 44. sunroof
- 45. windshield
- 46. antenna
- 47. hood
- 48. headlights
- 49. parking lights
- 50. turn signal (lights)
- 51. front bumper

F. Engine

- 52. air filter
- 53. fan belt
- 54. battery
- 55. terminal
- 56. radiator
- 57. hose
- 58. dipstick

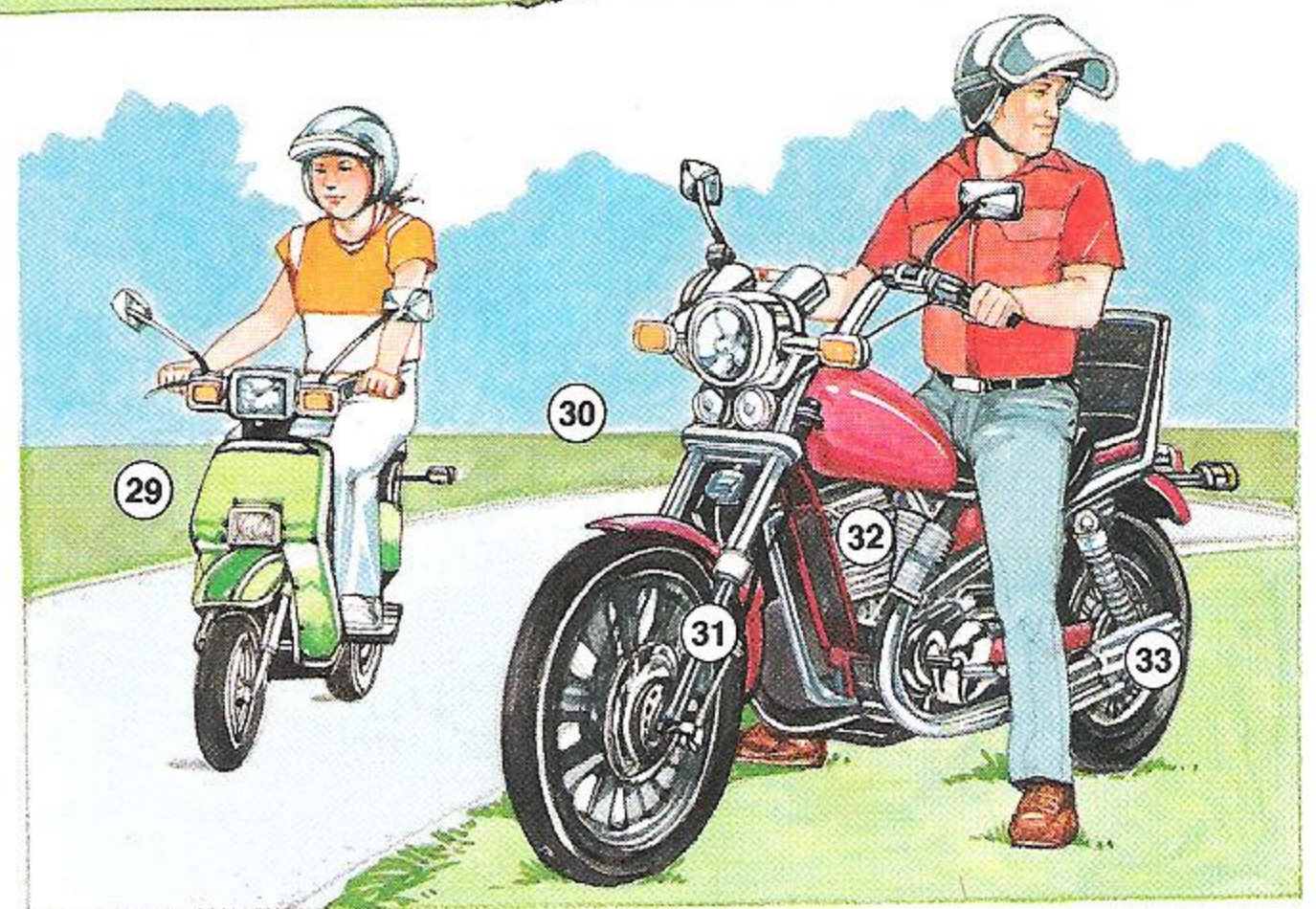
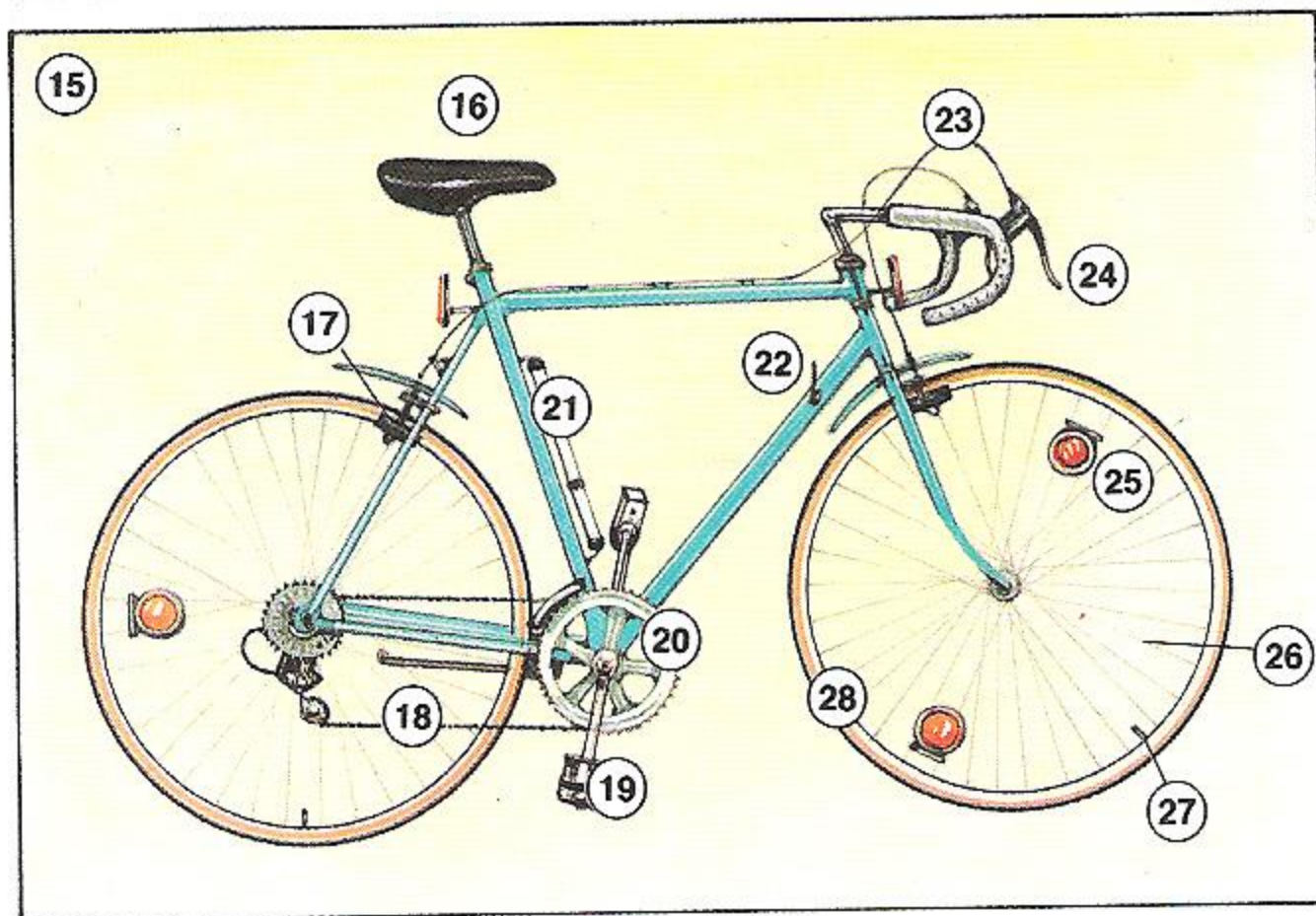
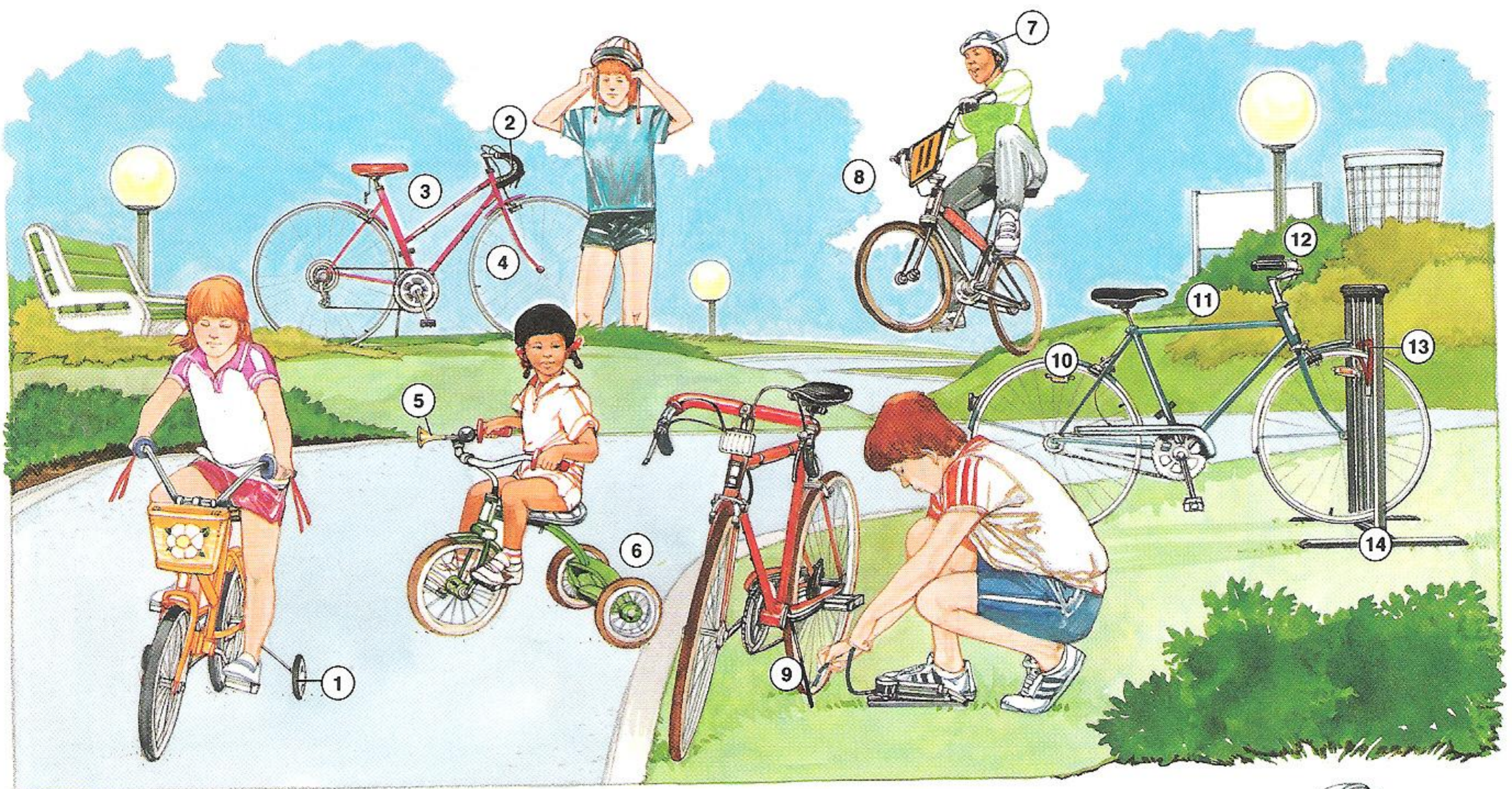

1. training wheels
2. (racing) handlebars
3. girl's frame
4. wheel
5. horn
6. tricycle
7. helmet
8. dirt bike
9. kickstand
10. fender
11. boy's frame

12. touring handlebars
13. lock
14. bike stand
15. bicycle
16. seat
17. brake
18. chain
19. pedal
20. sprocket
21. pump
22. gear changer

23. cable
24. hand brake
25. reflector
26. spoke
27. valve
28. tire
29. motor scooter
30. motorcycle
31. shock absorbers
32. engine
33. exhaust pipe



1. interstate highway
2. exit ramp
3. overpass
4. cloverleaf
5. left lane
6. center lane
7. right lane
8. speed limit sign
9. hitchhiker

10. trailer
11. service area
12. attendant
13. air pump
14. gas pump
15. passenger car
16. camper
17. sports car
18. center divider

19. motorcycle
20. bus
21. entrance ramp
22. shoulder
23. road sign
24. exit sign
25. truck
26. van
27. tollbooth

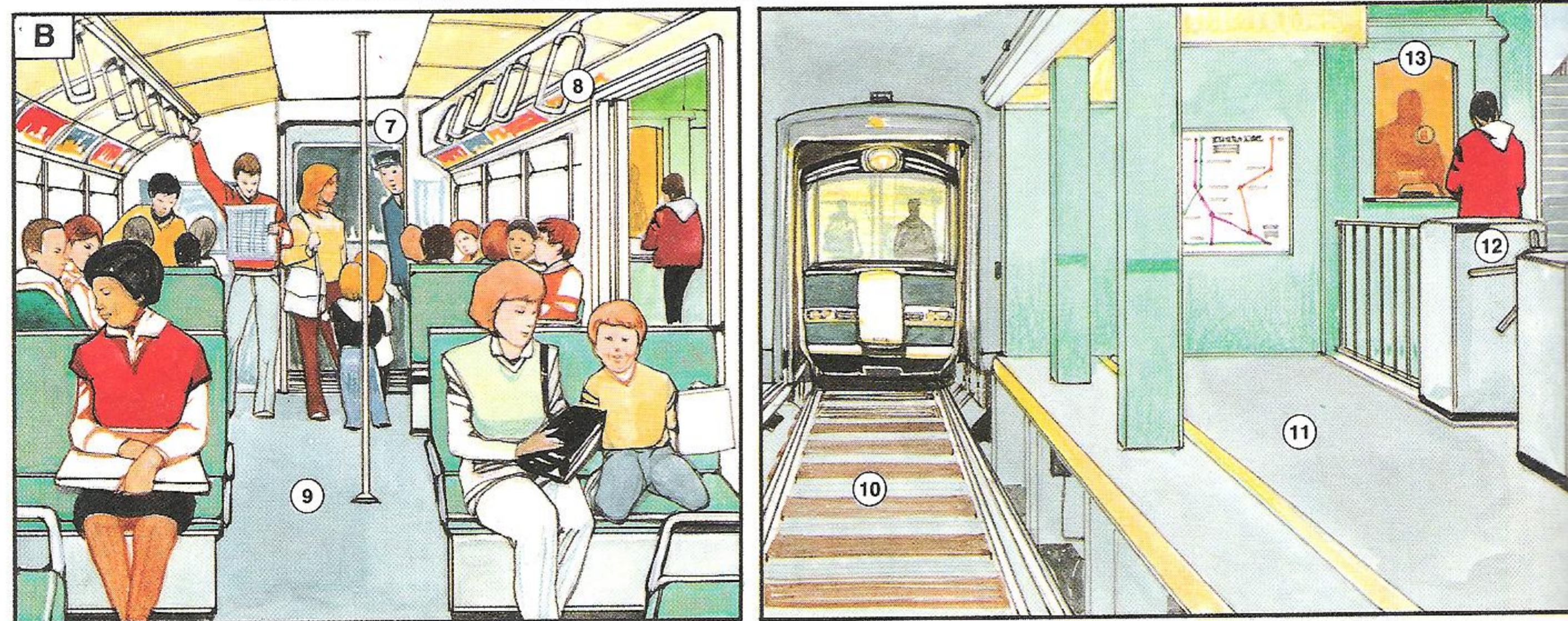
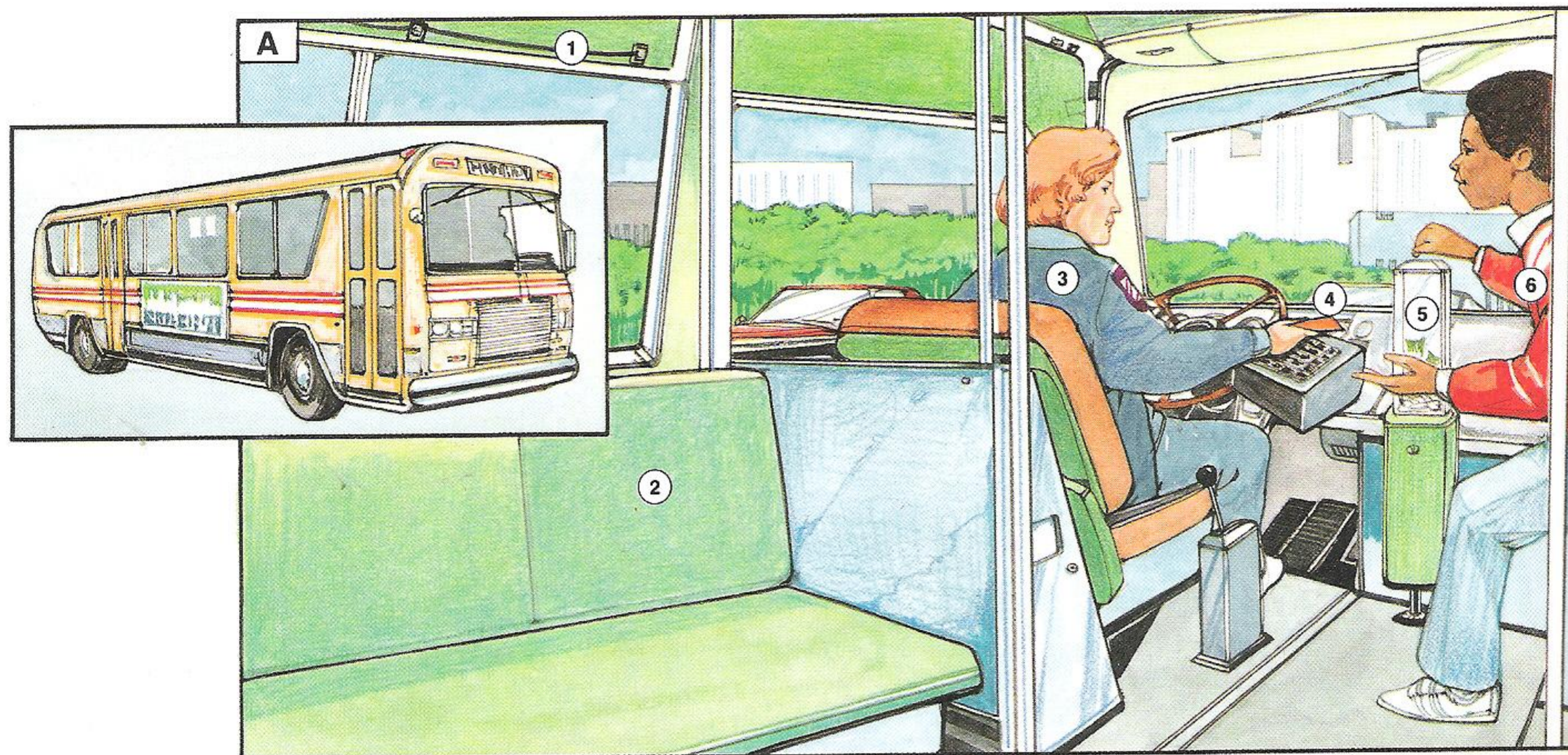

A. Bus

- 1. cord
- 2. seat
- 3. bus driver
- 4. transfer
- 5. fare box
- 6. rider

B. Subway

- 7. conductor
- 8. strap
- 9. car
- 10. track
- 11. platform
- 12. turnstile
- 13. token booth

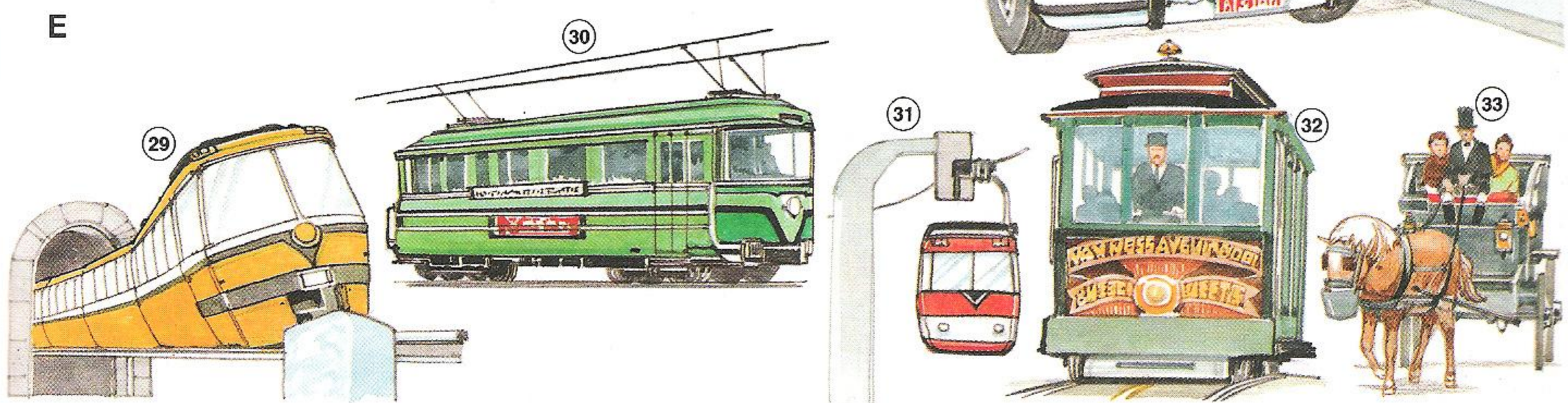
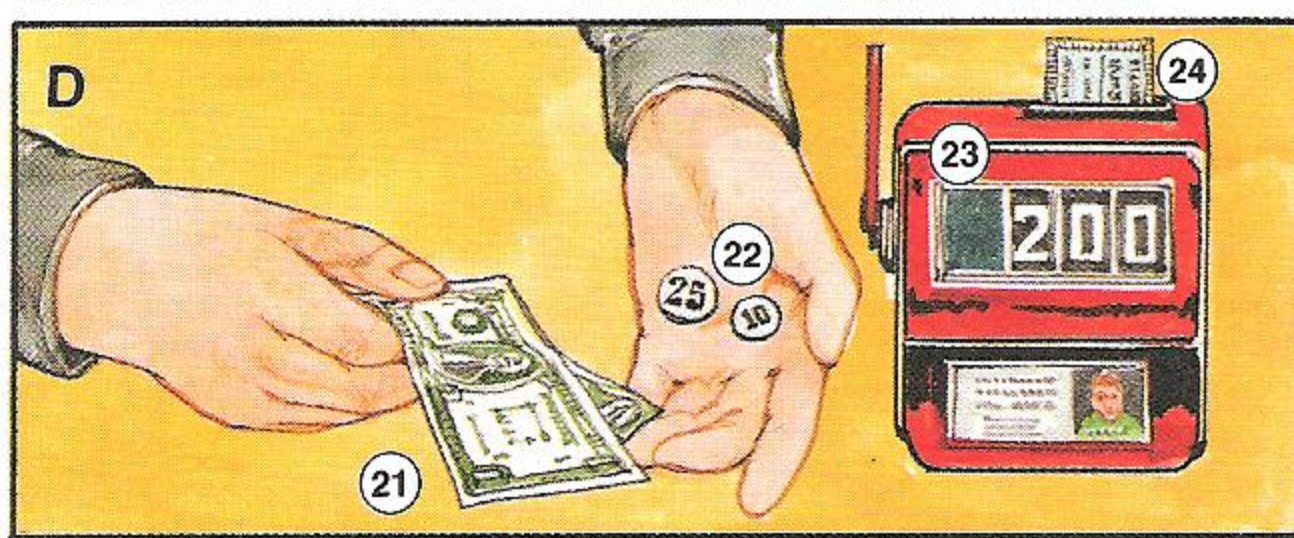

- C. Train**
 14. commuter train
 15. engineer
 16. ticket
 17. commuter
 18. station
 19. ticket window
 20. timetable

- D. Taxi**
 21. fare
 22. tip
 23. meter
 24. receipt
 25. passenger
 26. cab driver
 27. taxicab
 28. taxi stand

- E. Other Forms of Transportation**
 29. monorail
 30. streetcar
 31. aerial tramway
 32. cable car
 33. horse-drawn carriage

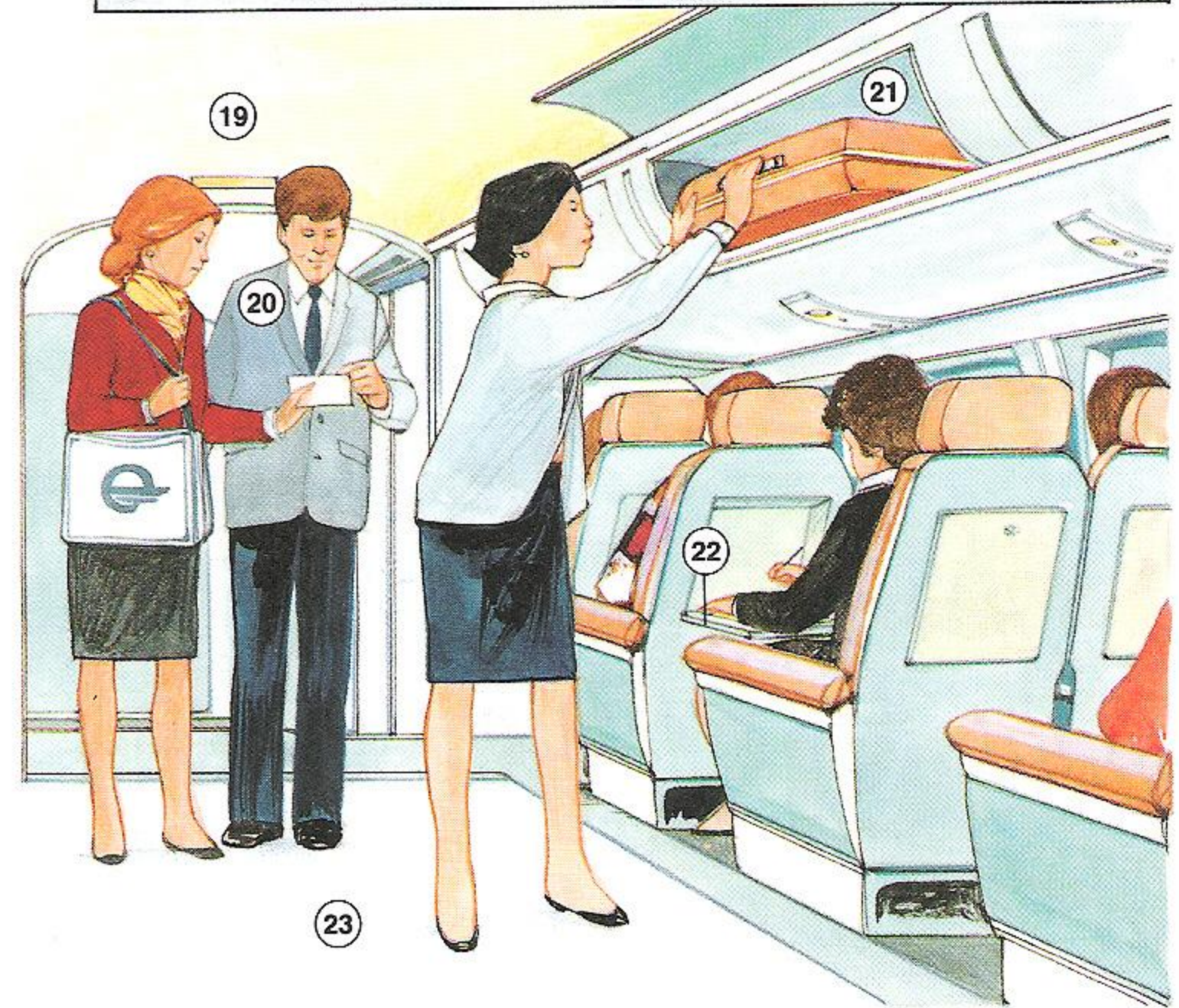
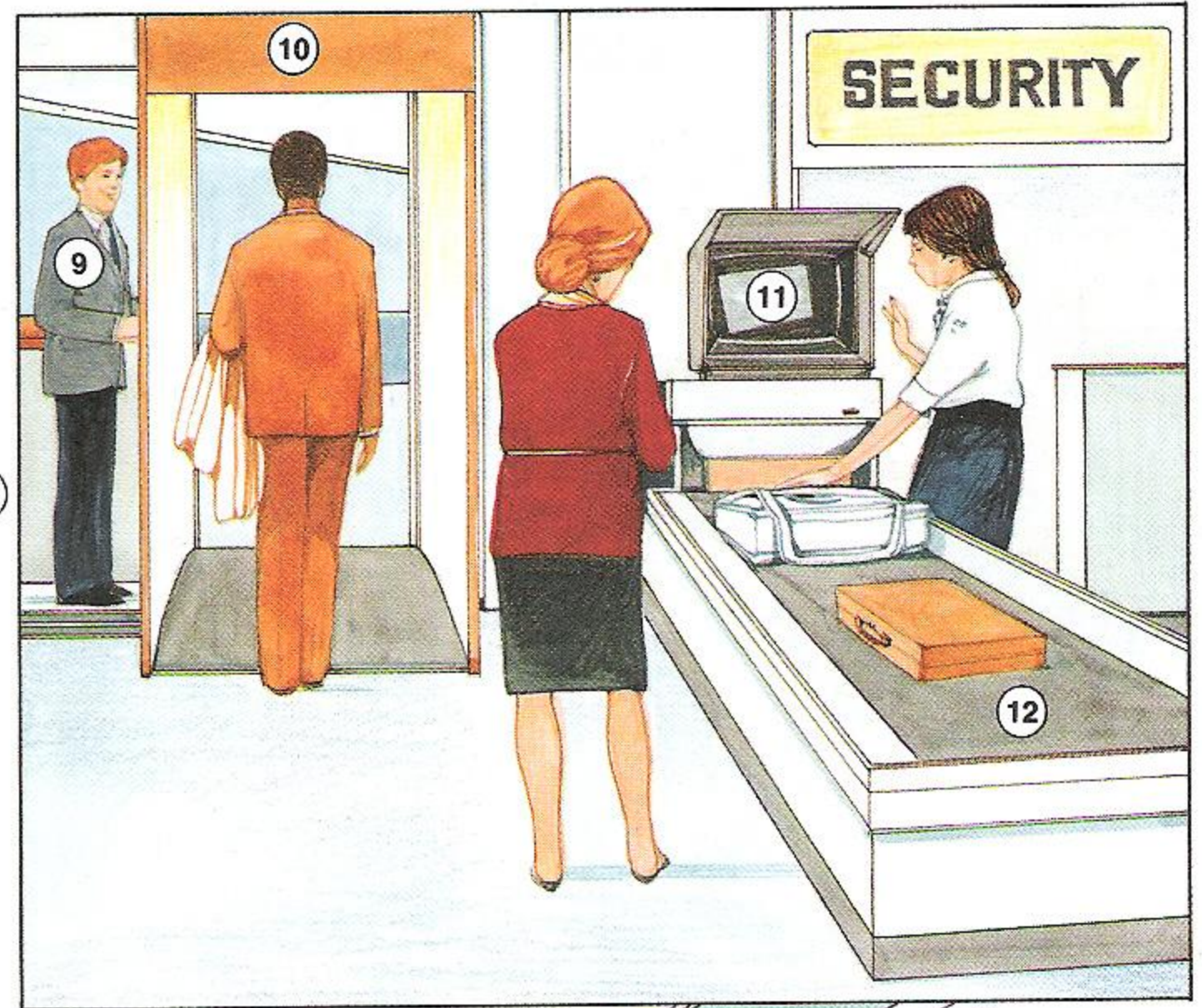
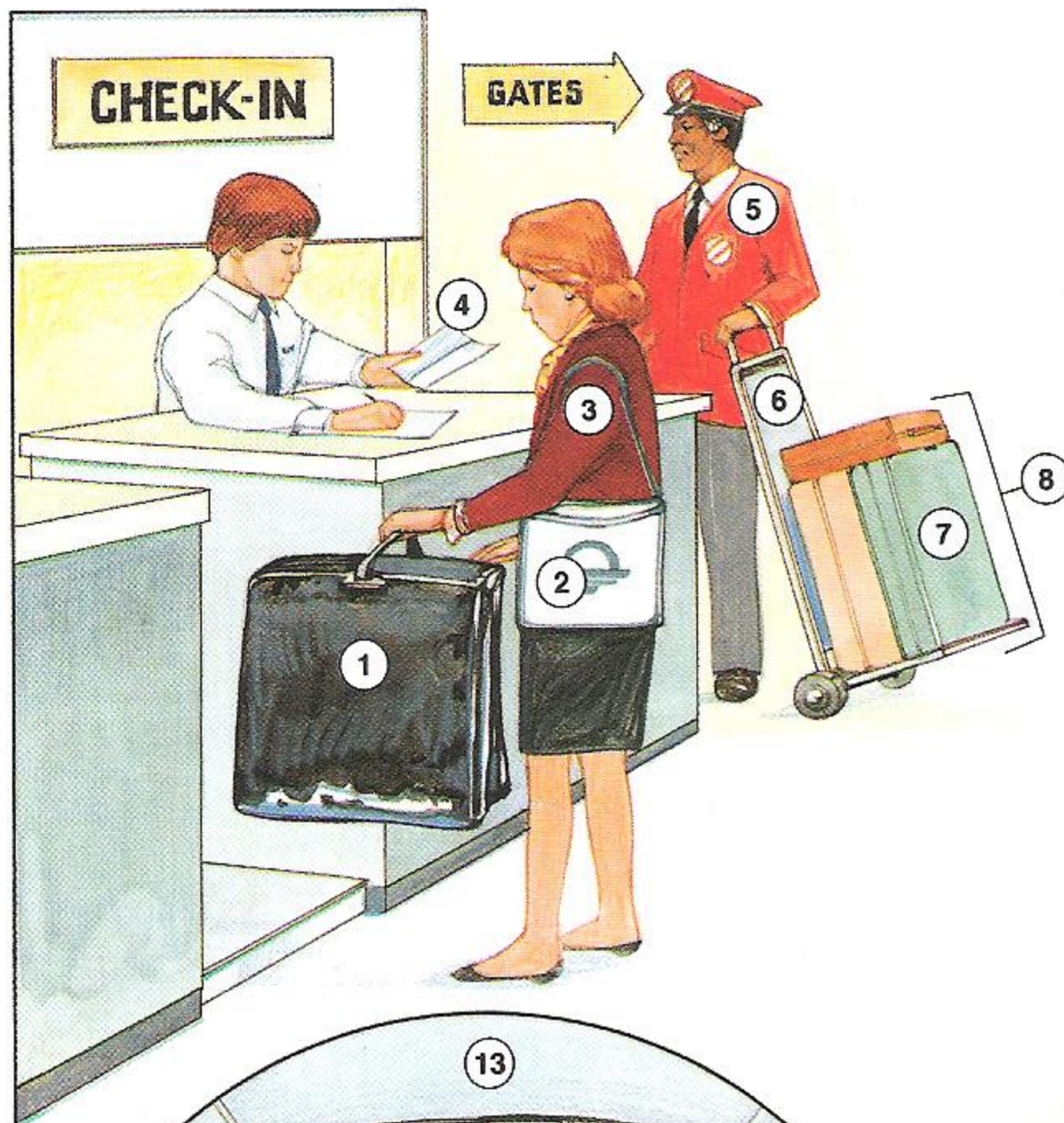

Airport Check-In

- 1. garment bag
- 2. carry-on bag
- 3. traveler
- 4. ticket
- 5. porter
- 6. dolly
- 7. suitcase
- 8. baggage

Security

- 9. security guard
- 10. metal detector
- 11. X-ray screener
- 12. conveyor belt

Boarding

- 13. cockpit
- 14. instruments
- 15. pilot
- 16. copilot
- 17. flight engineer
- 18. boarding pass
- 19. cabin
- 20. flight attendant
- 21. luggage compartment
- 22. tray table
- 23. aisle

A

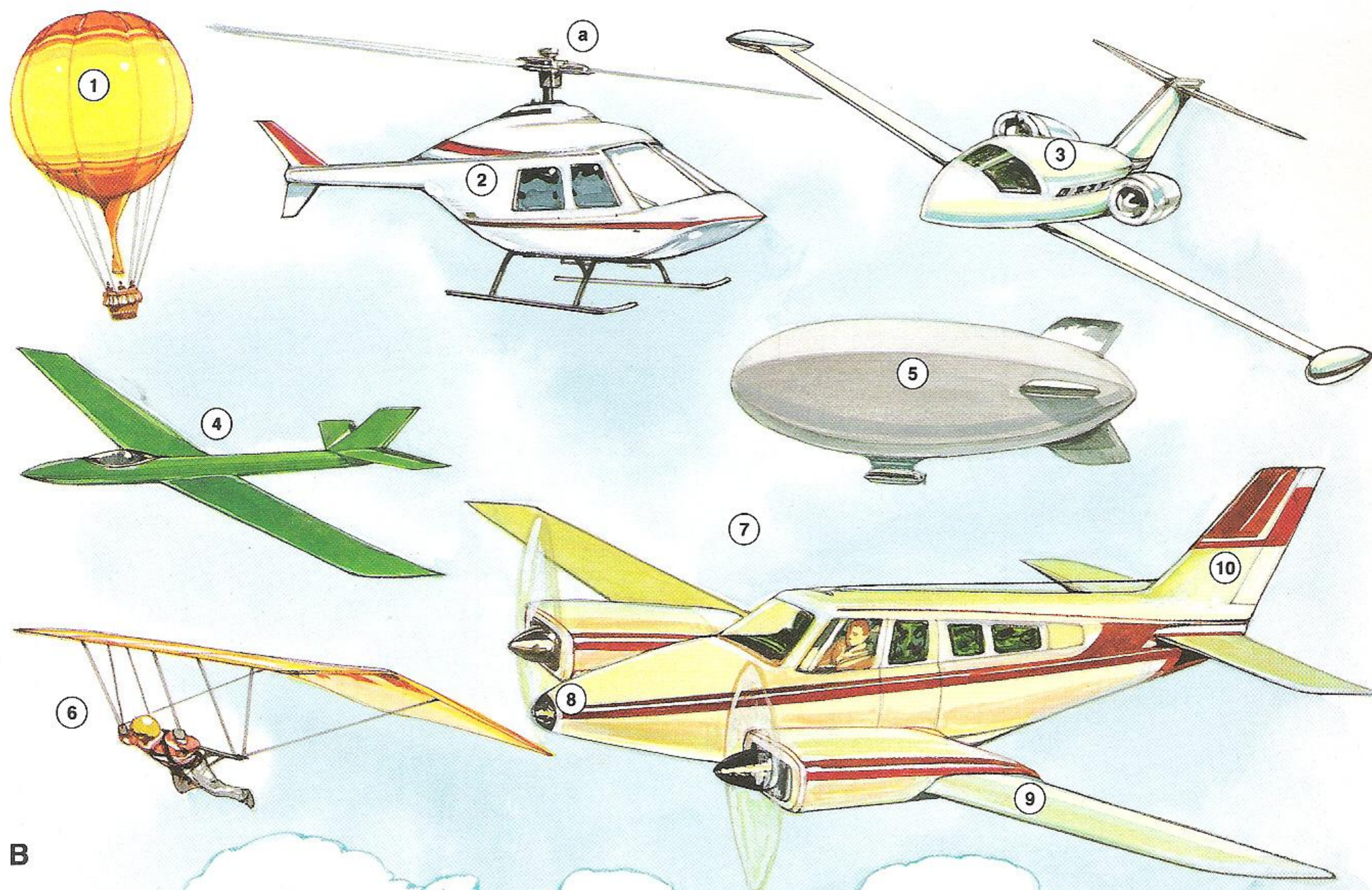

B

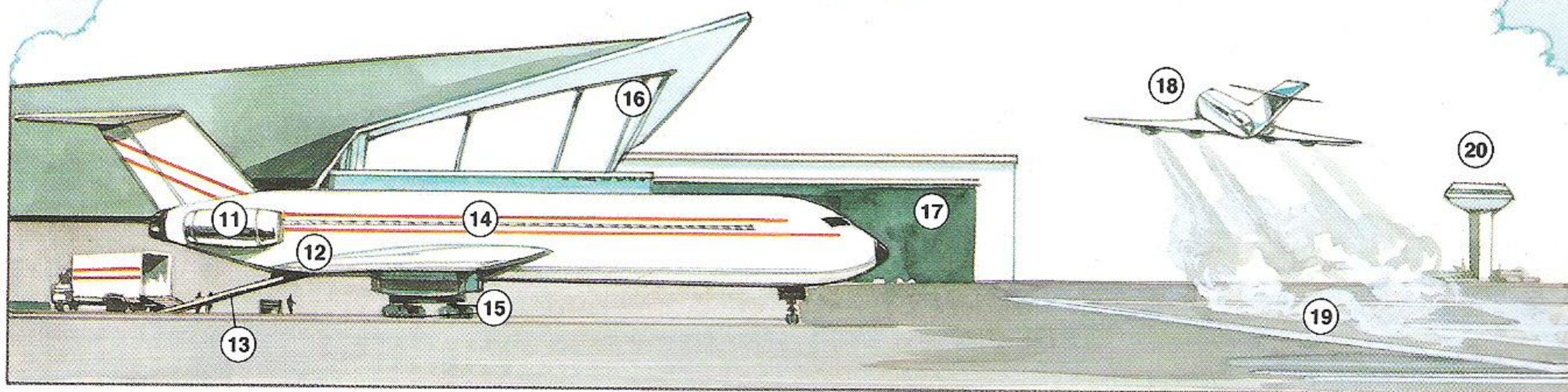
**A. Aircraft Types**

1. hot air balloon
2. helicopter
 - a. rotor
3. private jet
4. glider

5. blimp
6. hang glider
7. propeller plane
8. nose
9. wing
10. tail

B. Takeoff

11. jet engine
12. cargo area
13. cargo door
14. fuselage
15. landing gear
16. terminal building
17. hangar
18. (jet) plane
19. runway
20. control tower



- | | | |
|--------------------|----------------|-----------------|
| 1. fishing boat | 11. stern | 21. porthole |
| 2. fisherman | 12. barge | 22. deck |
| 3. pier | 13. tugboat | 23. windlass |
| 4. forklift | 14. lighthouse | 24. anchor |
| 5. bow | 15. tanker | 25. line |
| 6. crane | 16. buoy | 26. bollard |
| 7. container | 17. ferry | 27. ocean liner |
| 8. hold | 18. smokestack | 28. dock |
| 9. (container)ship | 19. lifeboat | 29. terminal |
| 10. cargo | 20. gangway | |



- 1. life jacket
- 2. canoe
- 3. paddle
- 4. sailboat
- 5. rudder
- 6. centerboard
- 7. boom
- 8. mast

- 9. sail
- 10. water-skier
- 11. towrope
- 12. outboard motor
- 13. motorboat
- 14. windsurfer
- 15. sailboard
- 16. cabin cruiser

- 17. kayak
- 18. dinghy
- 19. mooring
- 20. inflatable raft
- 21. oarlock
- 22. oar
- 23. rowboat



Flowers

- 1. tulip
a. stem
- 2. pansy
- 3. lily
- 4. (chrysanthe)mum
- 5. daisy
- 6. marigold
- 7. petunia
- 8. daffodil
a. bulb
- 9. crocus
- 10. hyacinth

- 11. iris
- 12. orchid
- 13. zinnia
- 14. gardenia
- 15. poinsettia
- 16. violet
- 17. buttercup
- 18. rose
a. bud
b. petal
c. thorn
- 19. sunflower

Grasses and Grains

- 20. sugarcane
- 21. rice
- 22. wheat
- 23. oats
- 24. corn



Trees

- 25. redwood
- 26. palm
- 27. eucalyptus
- 28. dogwood
- 29. magnolia
- 30. poplar
- 31. willow
- 32. birch
- 33. oak
 - a. twig
 - b. acorn

- 34. pine
 - a. needle
 - b. cone
- 35. tree
 - a. branch
 - b. trunk
 - c. bark
 - d. root
- 36. elm
 - a. leaf
- 37. holly
 - a. leaf
- 38. maple
 - a. leaf

Other Plants

- 39. house plants
- 40. cactus
- 41. bushes
- 42. vine

Poisonous Plants

- 43. poison oak
- 44. poison sumac
- 45. poison ivy



- 1. snail
 - a. shell
 - b. antenna
- 2. oyster
- 3. mussel
- 4. slug

- 5. squid
- 6. octopus
- 7. starfish
- 8. shrimp
- 9. crab
- 10. scallop

- 11. worm
- 12. jellyfish
 - a. tentacle
- 13. lobster
 - a. claw

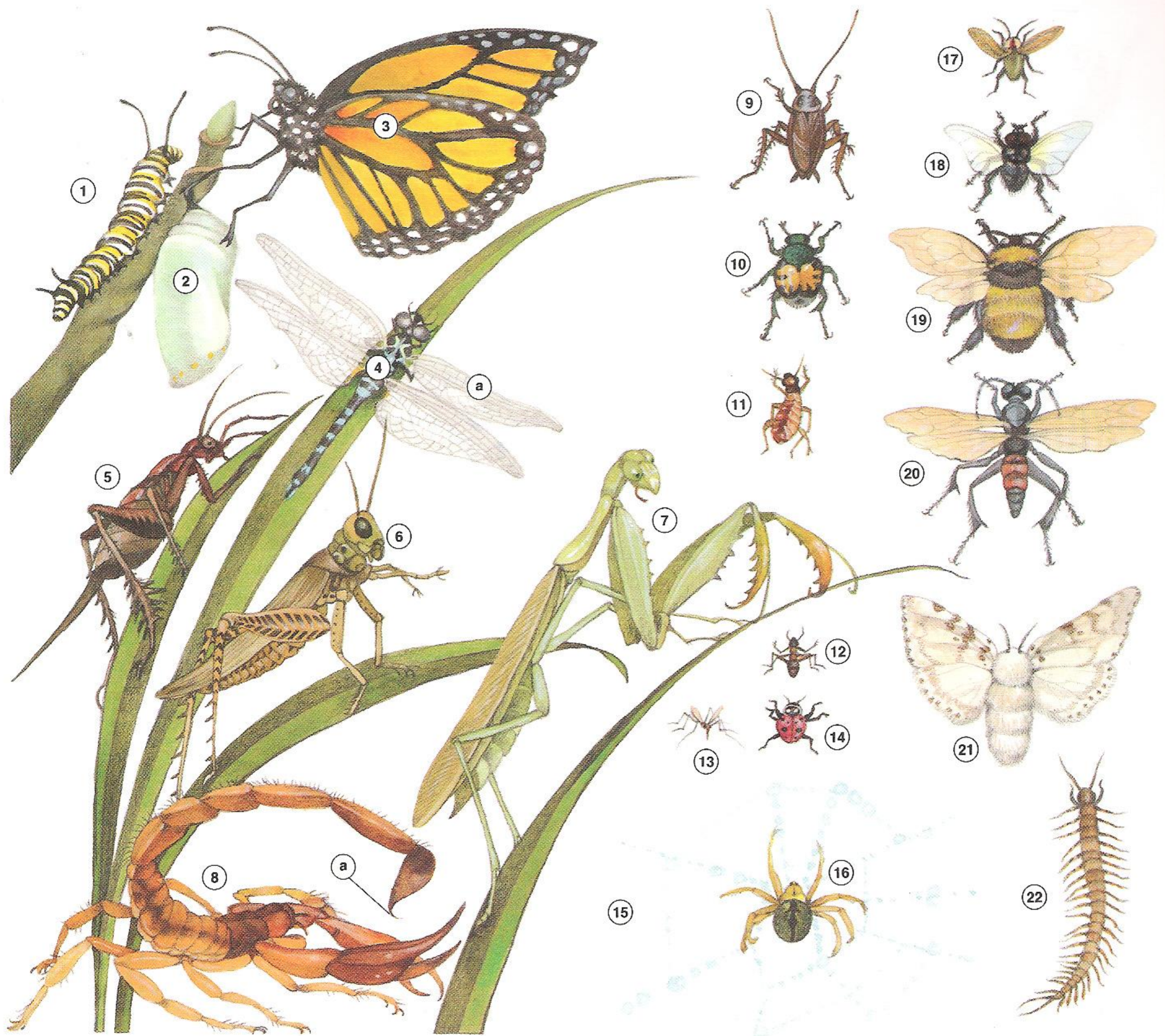

- 1. caterpillar
- 2. cocoon
- 3. butterfly
- 4. dragonfly
- a. wing
- 5. cricket
- 6. grasshopper
- 7. mantis

- 8. scorpion
- a. sting
- 9. cockroach
- 10. beetle
- 11. termite
- 12. ant
- 13. mosquito
- 14. ladybug

- 15. web
- 16. spider
- 17. firefly
- 18. fly
- 19. bee
- 20. wasp
- 21. moth
- 22. centipede



- | | | |
|----------------|----------------|----------------|
| 1. pigeon | 10. sparrow | 22. chick |
| a. wing | 11. cardinal | 23. chicken |
| 2. hummingbird | 12. ostrich | 24. pelican |
| 3. crow | 13. egg | a. bill |
| a. beak | 14. canary | 25. duck |
| 4. sea gull | 15. parakeet | 26. goose |
| 5. eagle | 16. parrot | 27. penguin |
| 6. owl | 17. woodpecker | 28. swan |
| 7. hawk | 18. peacock | 29. flamingo |
| a. feather | 19. pheasant | 30. stork |
| 8. blue jay | 20. turkey | 31. nest |
| 9. robin | 21. rooster | 32. roadrunner |

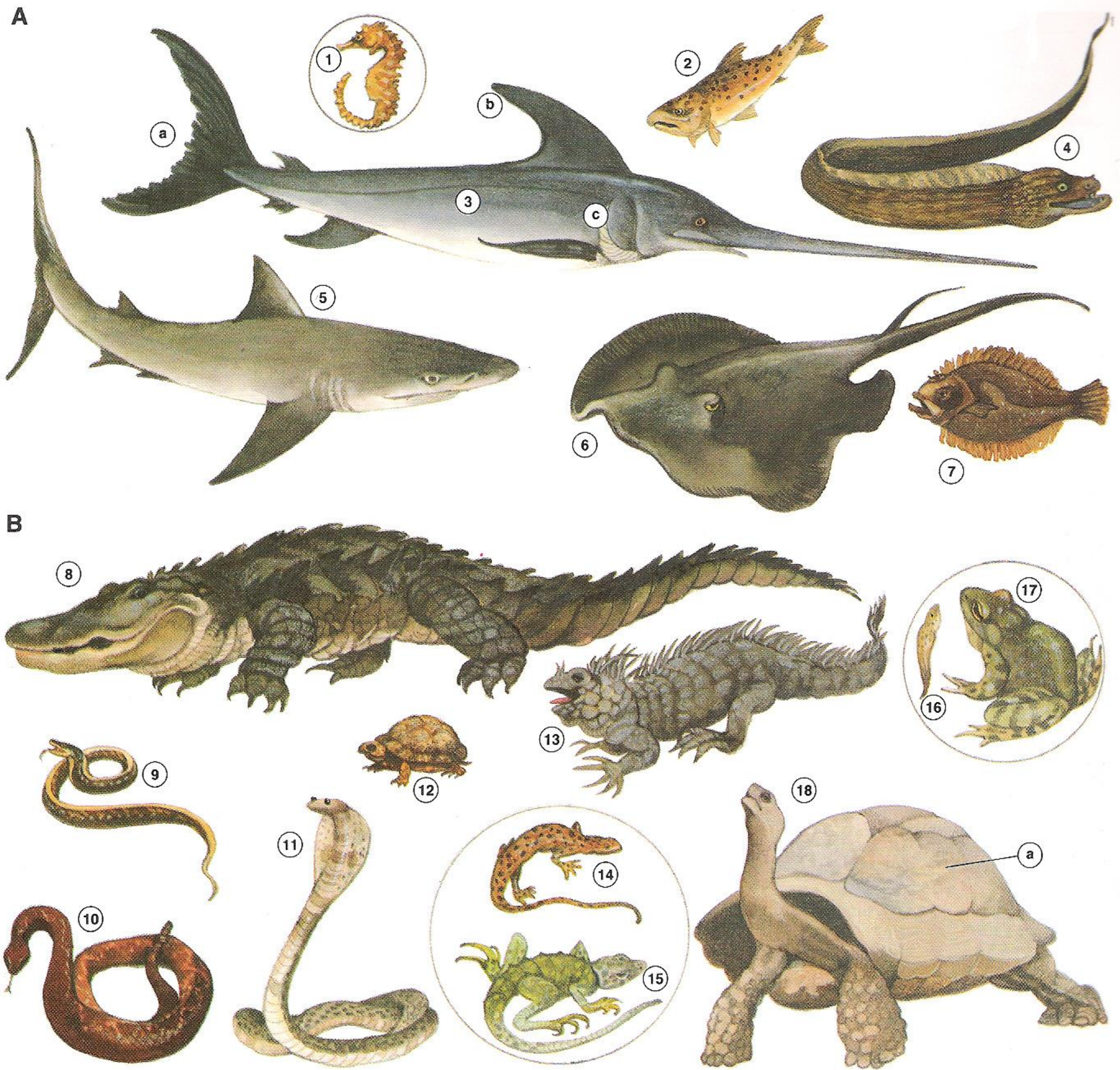

A. Fish

- 1. sea horse
- 2. trout
- 3. swordfish
- a. tail
- b. fin
- c. gill
- 4. eel
- 5. shark

6. stingray

7. flounder

B. Amphibians and Reptiles

- 8. alligator
- 9. (garter) snake
- 10. rattlesnake
- 11. cobra

12. turtle

13. iguana

14. salamander

15. lizard

16. tadpole

17. frog

18. tortoise

 a. shell

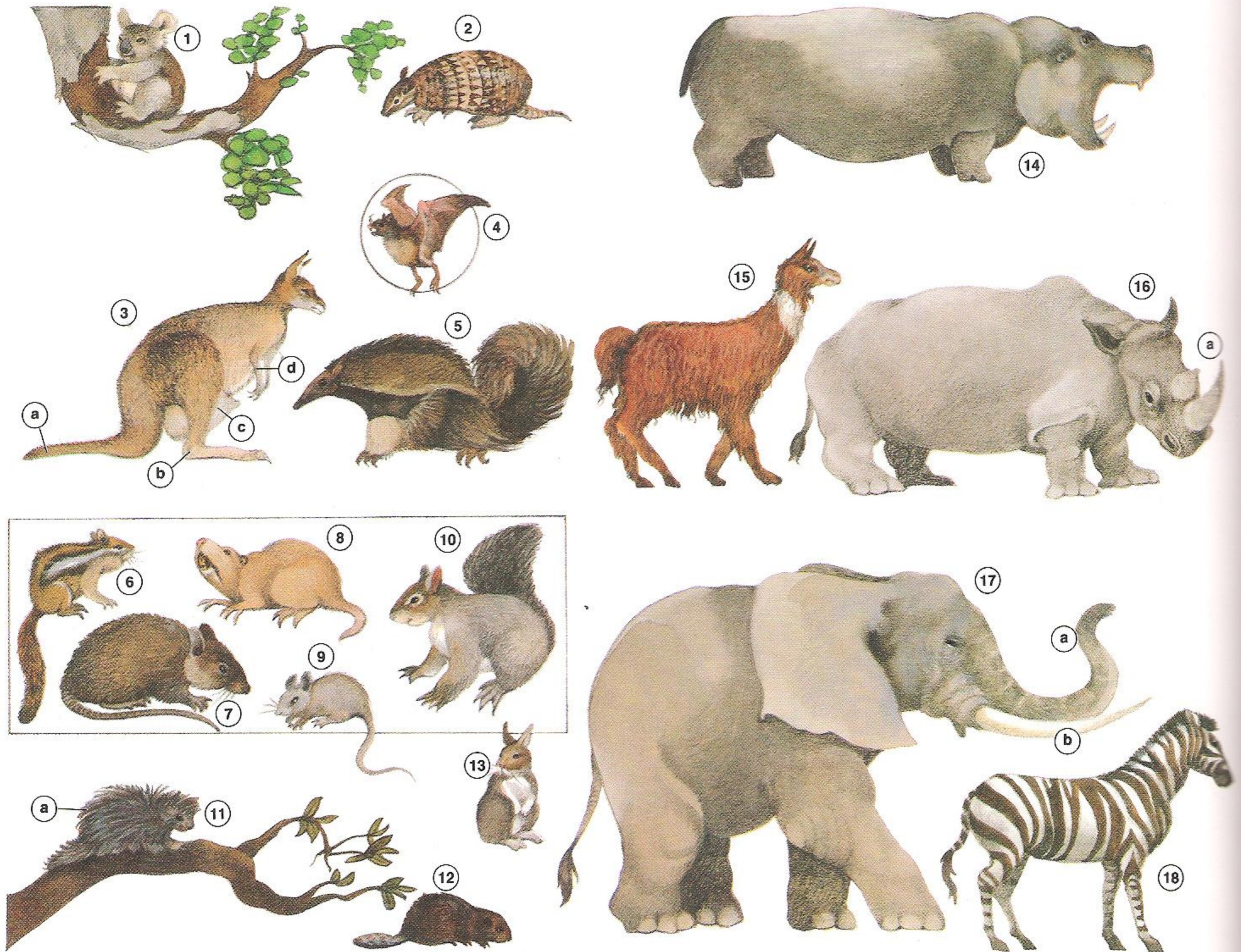

Pouched, Toothless, or Flying Mammals

- 1. koala
- 2. armadillo
- 3. kangaroo
 - a. tail
 - b. hind legs
 - c. pouch
 - d. forelegs
- 4. bat
- 5. anteater

Rodents

- 6. chipmunk
- 7. rat
- 8. gopher
- 9. mouse
- 10. squirrel
- 11. porcupine
 - a. quill
- 12. beaver
- 13. rabbit

Hoofed Mammals

- 14. hippopotamus
- 15. llama
- 16. rhinoceros
 - a. horn
- 17. elephant
 - a. trunk
 - b. tusk
- 18. zebra

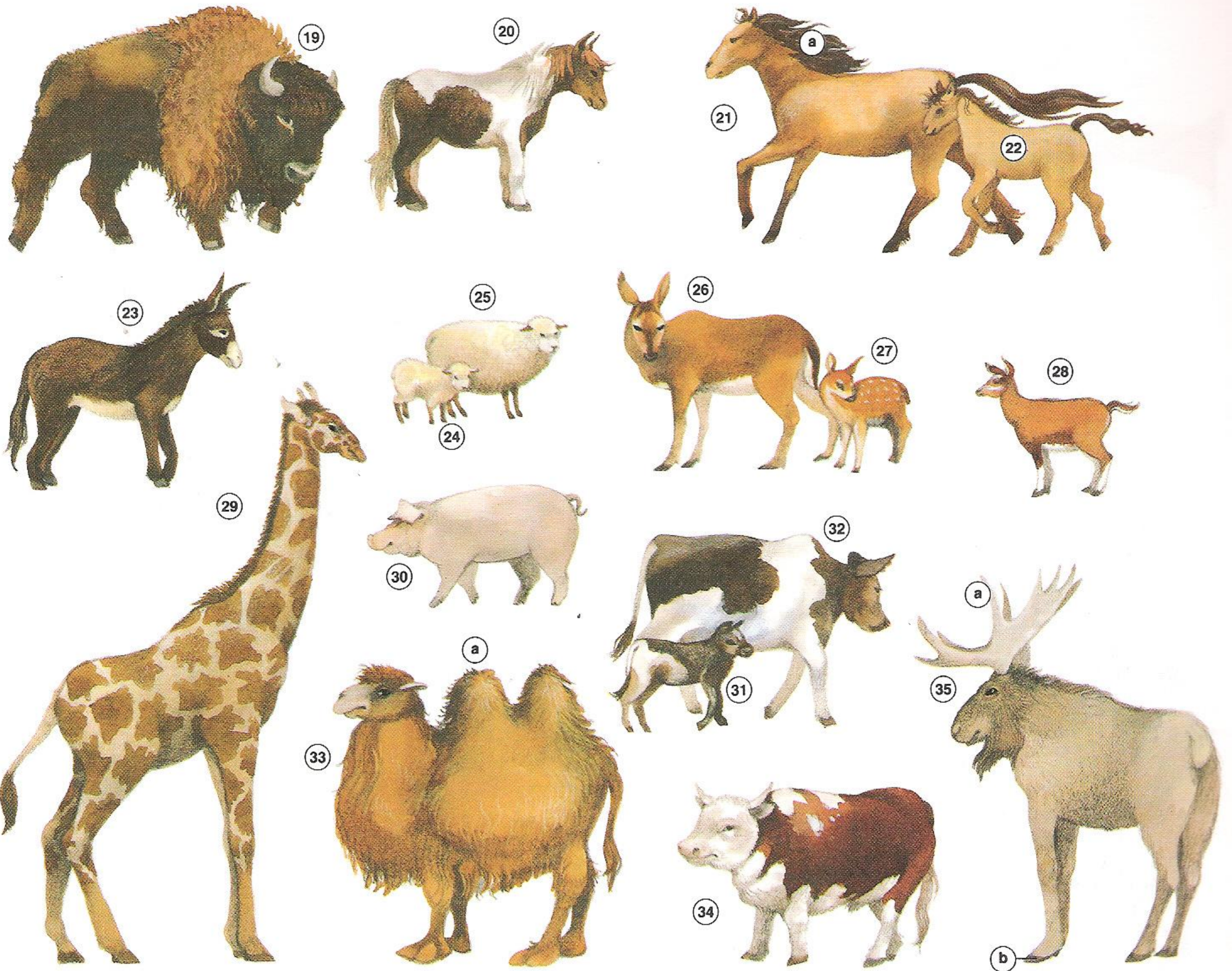

- 19. bison
- 20. pony
- 21. horse
- a. mane
- 22. foal
- 23. donkey
- 24. lamb

- 25. sheep
- 26. deer
- 27. fawn
- 28. goat
- 29. giraffe
- 30. hog
- 31. calf

- 32. cow
- 33. camel
- a. hump
- 34. bull
- 35. moose
- a. antler
- b. hoof



- 1. leopard
- 2. tiger
- a. claw
- 3. lion
- 4. cat

- 5. kitten
- 6. fox
- 7. raccoon
- 8. skunk

- Aquatic Mammals**
- 9. whale
 - 10. otter
 - 11. walrus
 - 12. seal
 - a. flipper
 - 13. dolphin



Primates

- 14. monkey
- 15. gibbon
- 16. chimpanzee
- 17. gorilla
- 18. orangutan
- 19. baboon

Bears

- 20. panda
- 21. black bear
- 22. polar bear
- 23. grizzly bear

Dogs

- 24. spaniel
- 25. terrier
- 26. retriever
- 27. puppy
- 28. shepherd
- 29. wolf
- a. paw
- 30. hyena



Continents

- 1. North America
- 2. South America
- 3. Europe
- 4. Africa
- 5. Asia
- 6. Australia
- 7. Antarctica

Oceans

- 8. Arctic
- 9. North Pacific
- 10. South Pacific
- 11. North Atlantic
- 12. South Atlantic
- 13. Indian
- 14. Antarctic

Seas, Gulfs, and Bays

- 15. Beaufort Sea
- 16. Baffin Bay
- 17. Gulf of Alaska
- 18. Hudson Bay
- 19. Gulf of Mexico

- 20. Caribbean Sea
- 21. North Sea
- 22. Baltic Sea
- 23. Barents Sea
- 24. Mediterranean Sea
- 25. Gulf of Guinea
- 26. Black Sea
- 27. Caspian Sea
- 28. Persian Gulf
- 29. Red Sea

- 30. Arabian Sea
- 31. Kara Sea
- 32. Bay of Bengal
- 33. Laptev Sea
- 34. Bering Sea
- 35. Sea of Okhotsk
- 36. Sea of Japan
- 37. Yellow Sea
- 38. East China Sea
- 39. South China Sea

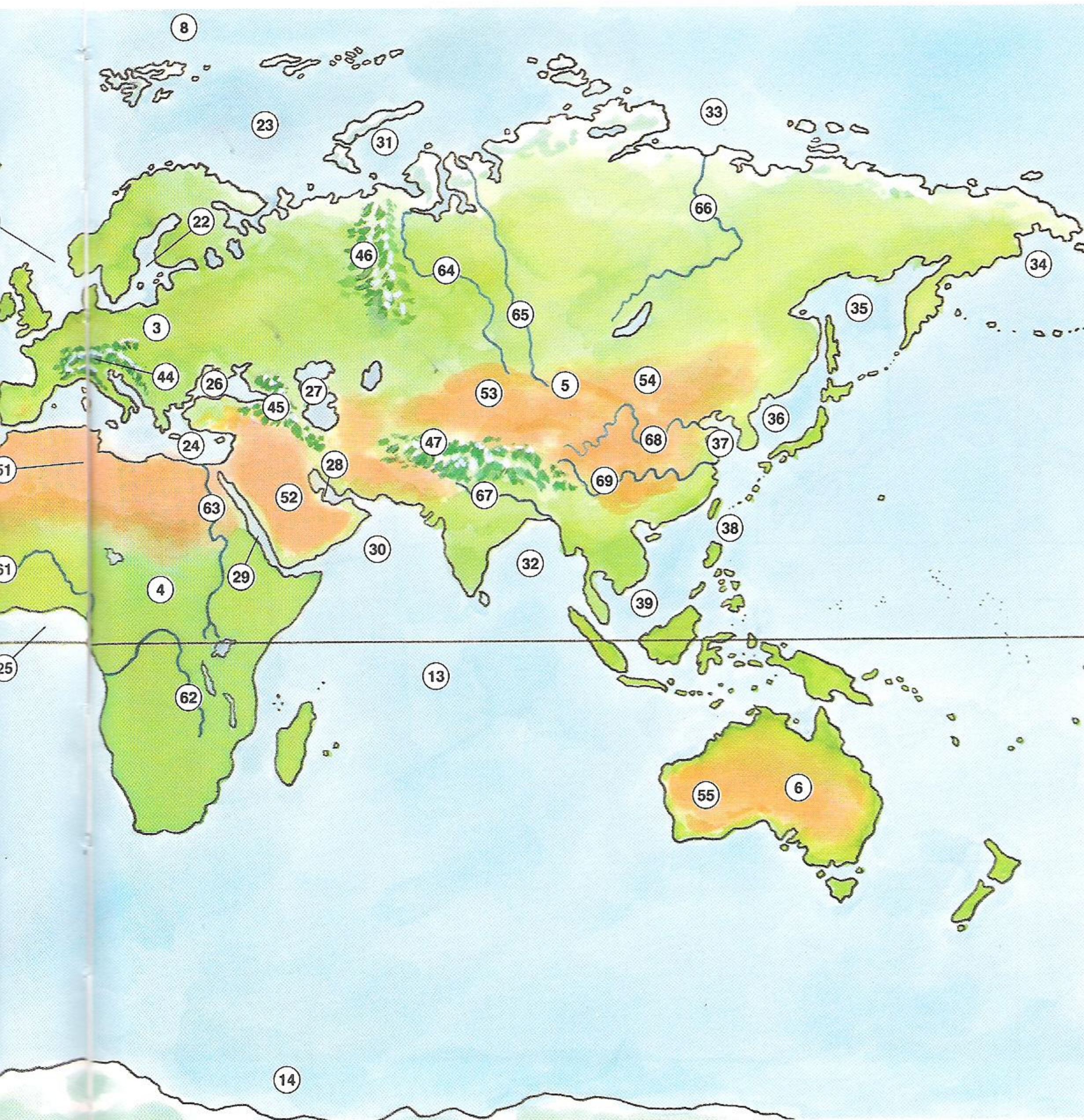

Mountain Ranges

- 40. Rocky Mountains
- 41. Appalachian Mountains
- 42. Sierra Madre
- 43. Andes
- 44. Alps
- 45. Caucasus
- 46. Urals
- 47. Himalayas

Deserts

- 48. Mojave
- 49. Painted
- 50. Atacama
- 51. Sahara
- 52. Rub' al Khali
- 53. Takla Makan
- 54. Gobi
- 55. Great Sandy

Rivers

- 56. Yukon
- 57. Rio Grande
- 58. Mississippi
- 59. Amazon
- 60. Paraná
- 61. Niger
- 62. Congo
- 63. Nile
- 64. Ob
- 65. Yenisey
- 66. Lena
- 67. Ganges
- 68. Huang
- 69. Yangtze

- 70. equator
- 71. north
- 72. south
- 73. east
- 74. west

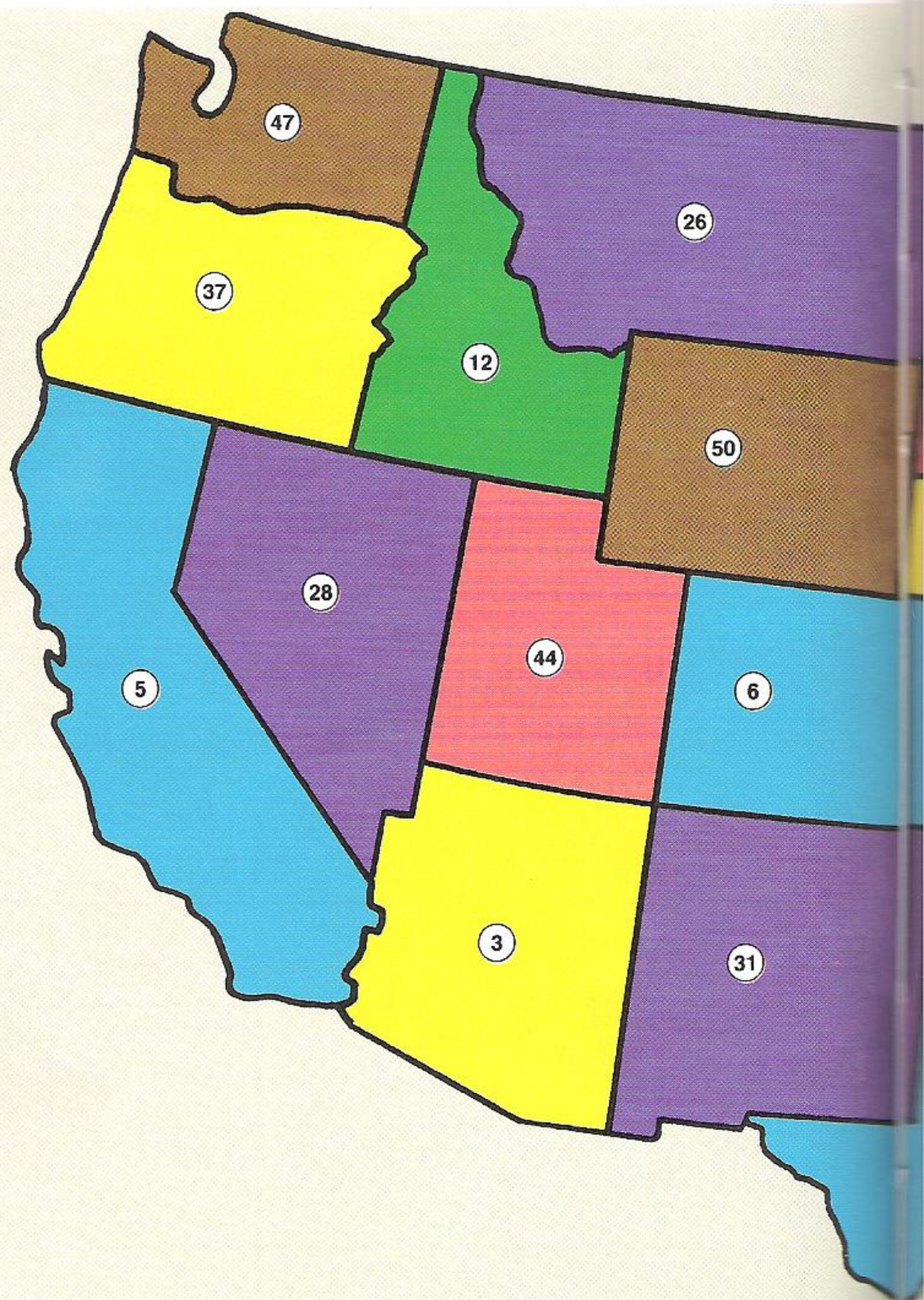
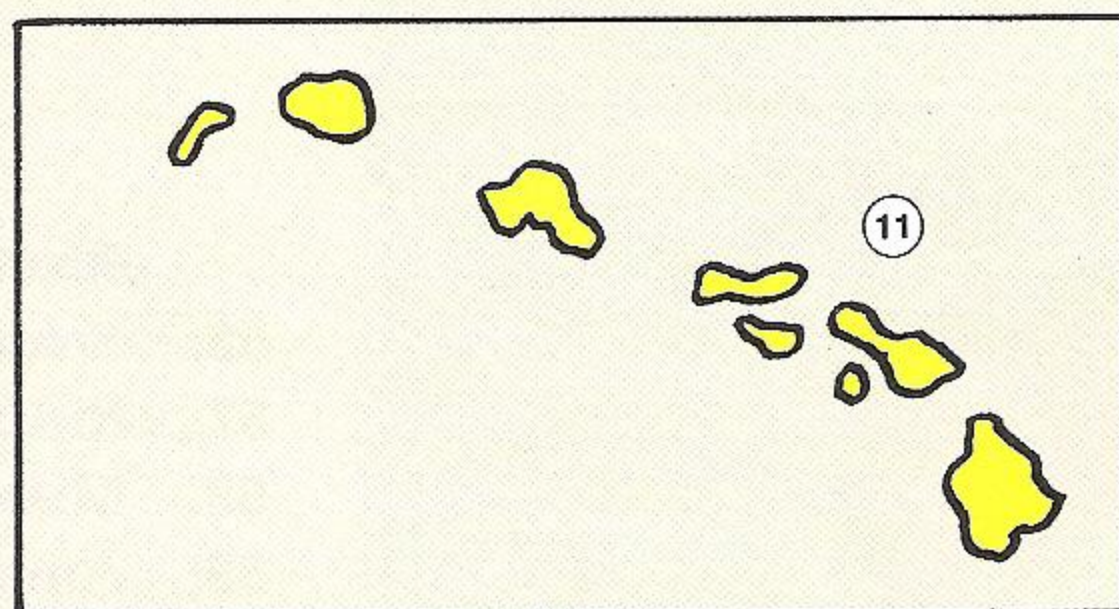
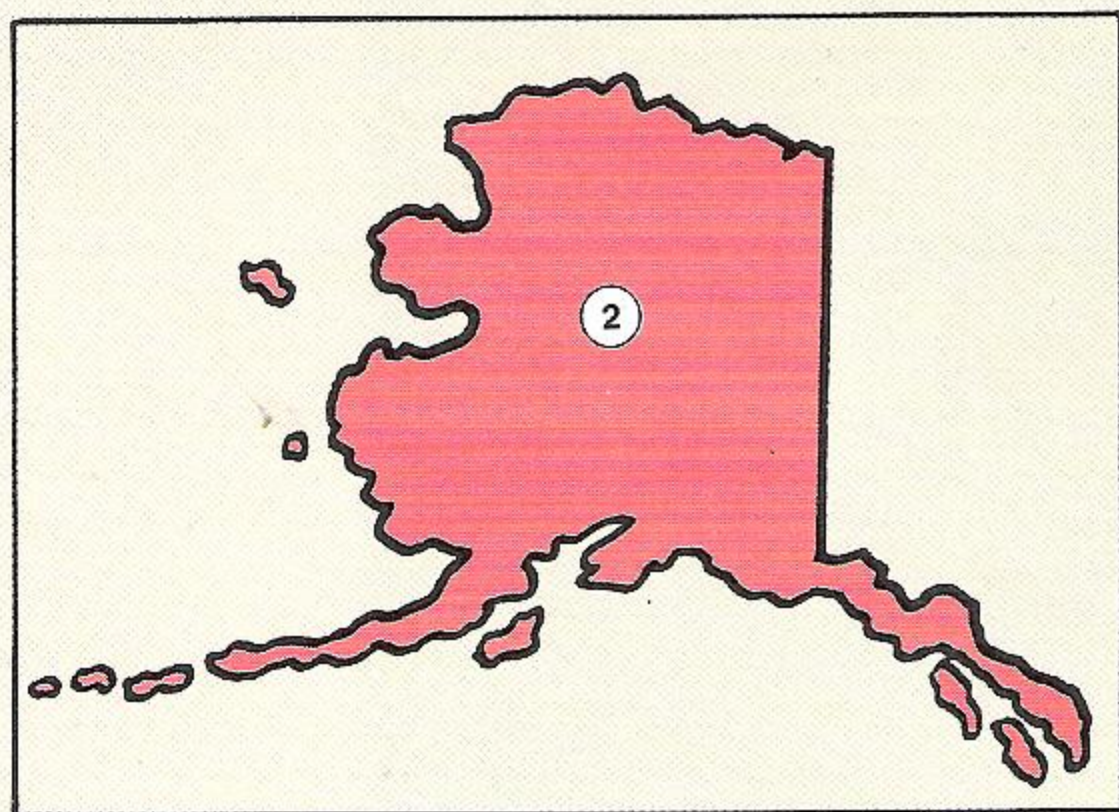

- 1. Alabama
- 2. Alaska
- 3. Arizona
- 4. Arkansas
- 5. California
- 6. Colorado
- 7. Connecticut
- 8. Delaware

- 9. Florida
- 10. Georgia
- 11. Hawaii
- 12. Idaho
- 13. Illinois
- 14. Indiana
- 15. Iowa
- 16. Kansas

- 17. Kentucky
- 18. Louisiana
- 19. Maine
- 20. Maryland
- 21. Massachusetts
- 22. Michigan
- 23. Minnesota
- 24. Mississippi

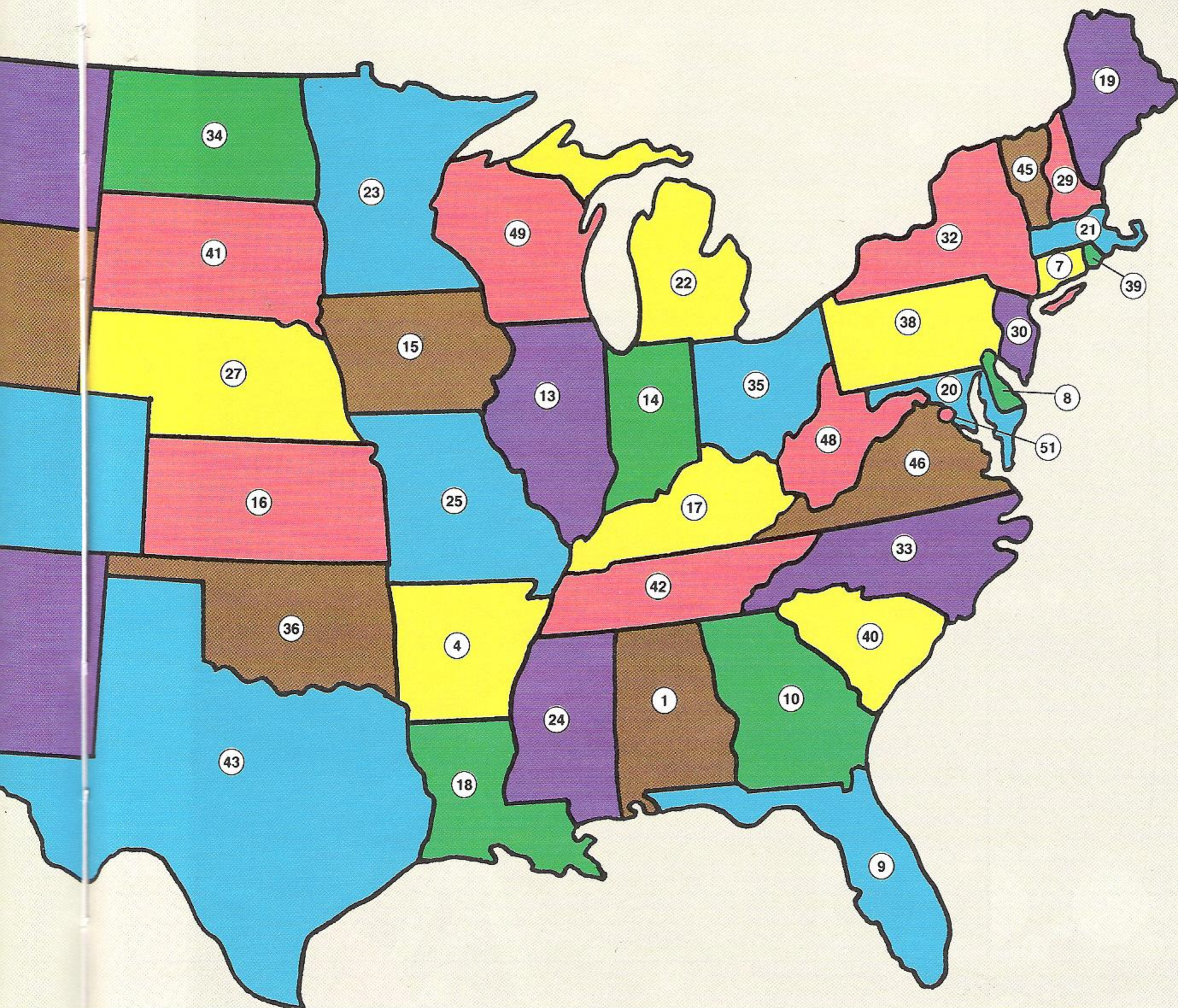

- | | | |
|--------------------|--------------------|--------------------------|
| 25. Missouri | 34. North Dakota | 43. Texas |
| 26. Montana | 35. Ohio | 44. Utah |
| 27. Nebraska | 36. Oklahoma | 45. Vermont |
| 28. Nevada | 37. Oregon | 46. Virginia |
| 29. New Hampshire | 38. Pennsylvania | 47. Washington |
| 30. New Jersey | 39. Rhode Island | 48. West Virginia |
| 31. New Mexico | 40. South Carolina | 49. Wisconsin |
| 32. New York | 41. South Dakota | 50. Wyoming |
| 33. North Carolina | 42. Tennessee | 51. District of Columbia |

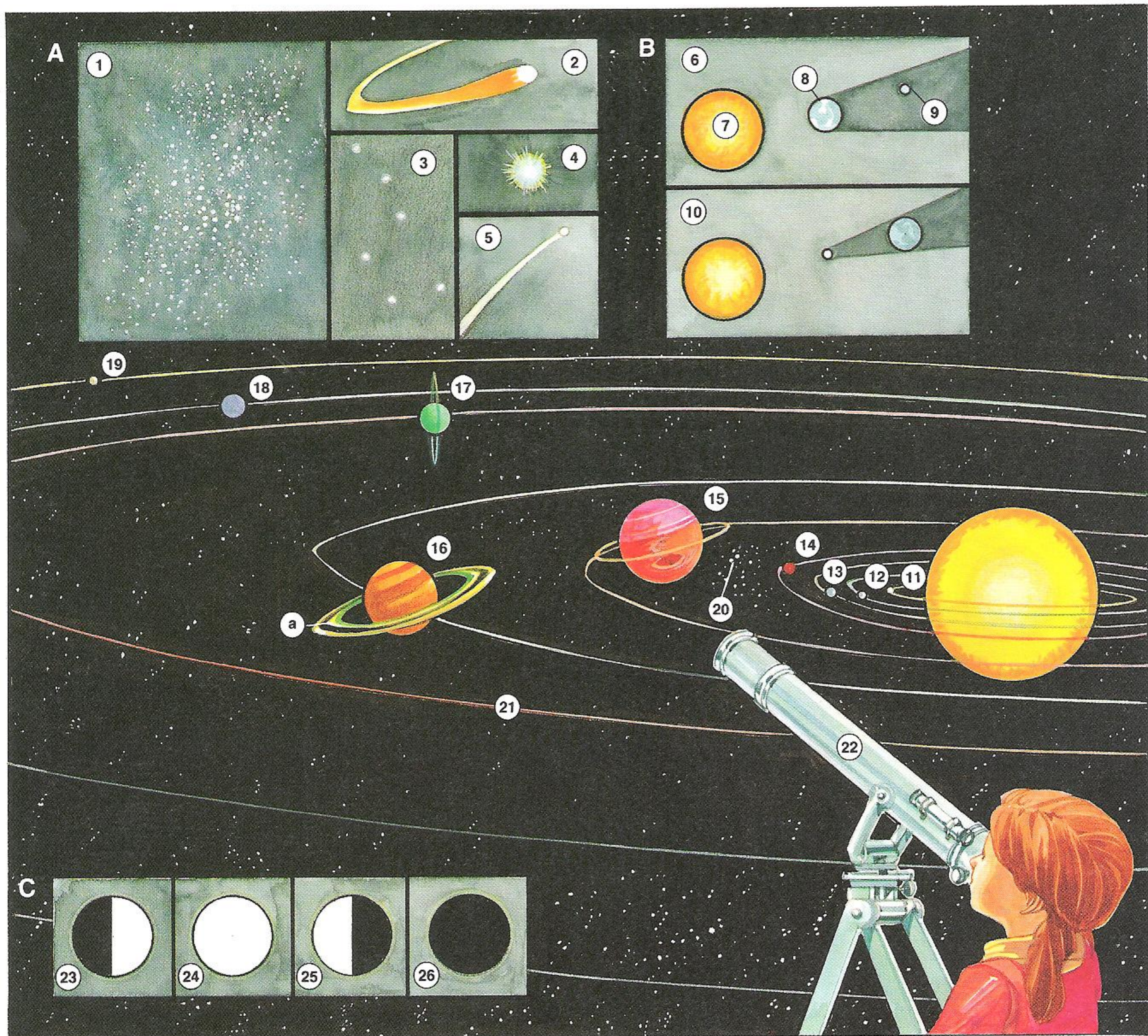

A. Outer Space

- 1. galaxy
- 2. comet
- 3. (Big Dipper) constellation
- 4. star
- 5. meteor

B. The Solar System

- 6. lunar eclipse
- 7. Sun
- 8. Earth

- 9. Moon
- 10. solar eclipse
- The Planets**
- 11. Mercury
- 12. Venus
- 13. Earth
- 14. Mars
- 15. Jupiter
- 16. Saturn
- a. ring
- 17. Uranus

- 18. Neptune
- 19. Pluto
- 20. asteroid
- 21. orbit
- 22. telescope

C. Phases of the Moon

- 23. first quarter
- 24. full moon
- 25. last quarter
- 26. new moon

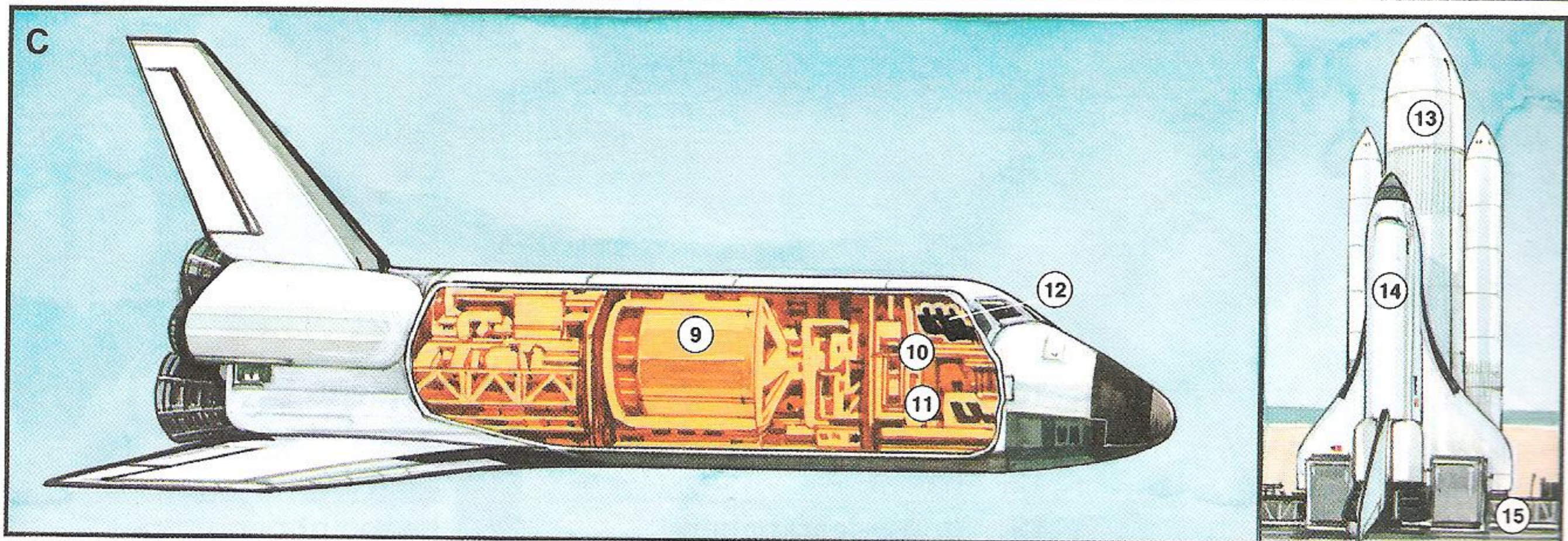
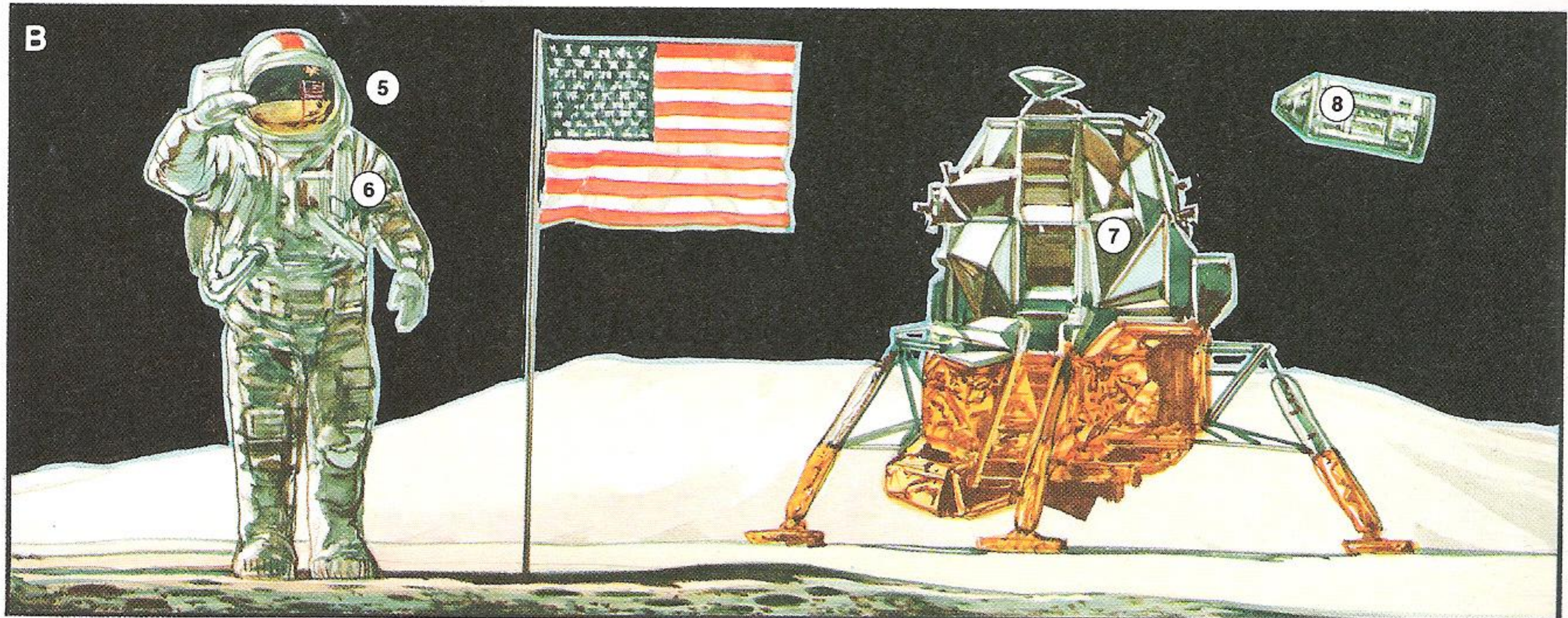
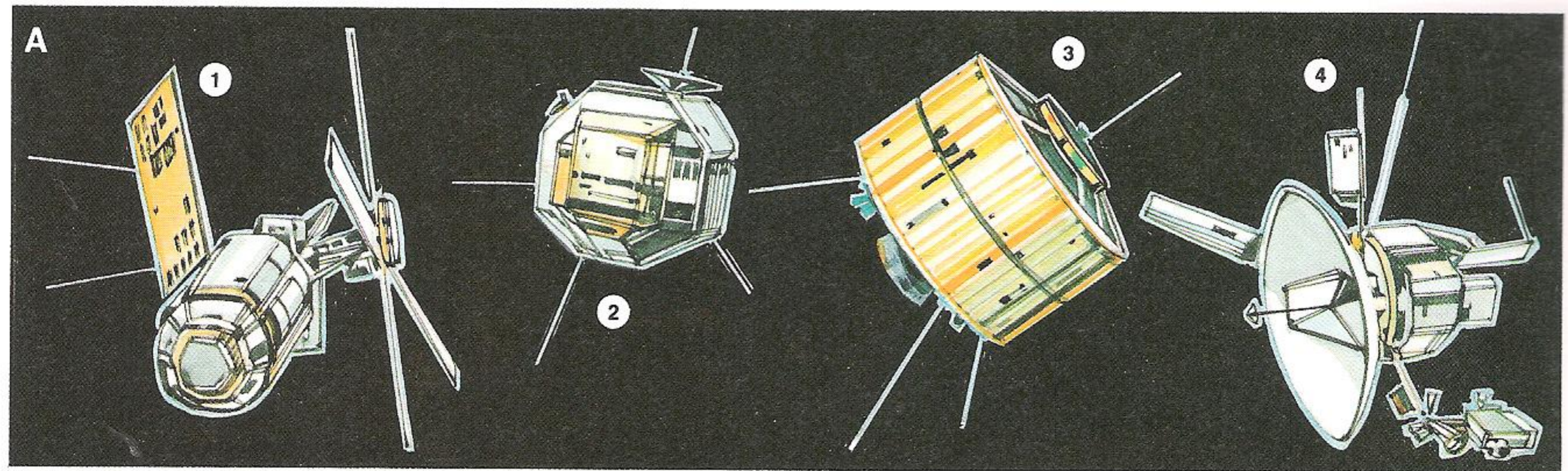

A. Spacecraft

1. space station
2. communication satellite
3. weather satellite
4. space probe

B. Landing on the Moon

5. astronaut
6. space suit
7. lunar module
8. command module

C. The Space Shuttle

9. cargo bay
10. flight deck
11. living quarters
12. crew
13. rocket
14. space shuttle
15. launchpad



- | | | |
|-------------------|------------------------|------------------------|
| 1. flag | 10. chalk | 19. student |
| 2. clock | 11. eraser | 20. pencil sharpener |
| 3. loudspeaker | 12. hall | 21. pencil eraser |
| 4. teacher | 13. (loose-leaf) paper | 22. ballpoint pen |
| 5. chalkboard | 14. ring binder | 23. ruler |
| 6. locker | 15. spiral notebook | 24. pencil |
| 7. bulletin board | 16. desk | 25. thumbtack |
| 8. computer | 17. glue | 26. (text)book |
| 9. chalk tray | 18. brush | 27. overhead projector |



1



2

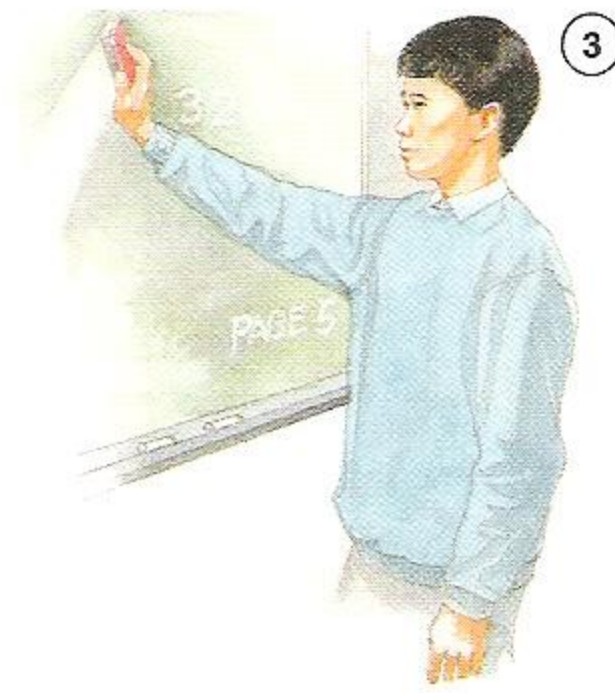

3

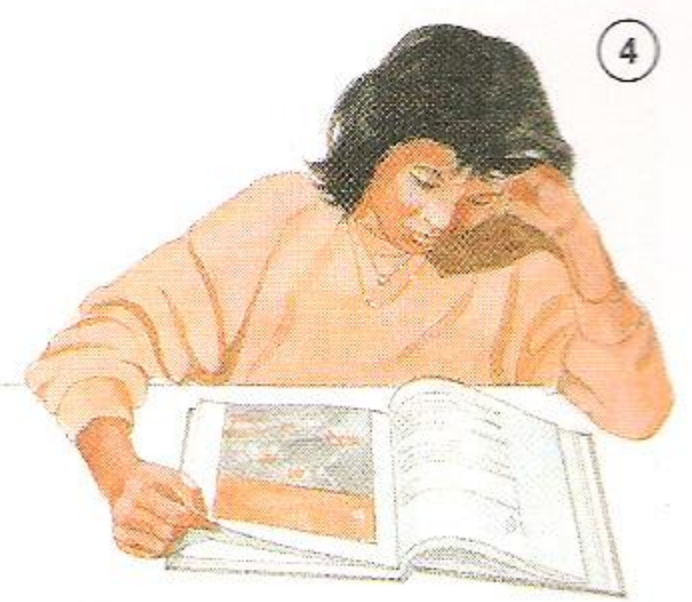

4



5



6

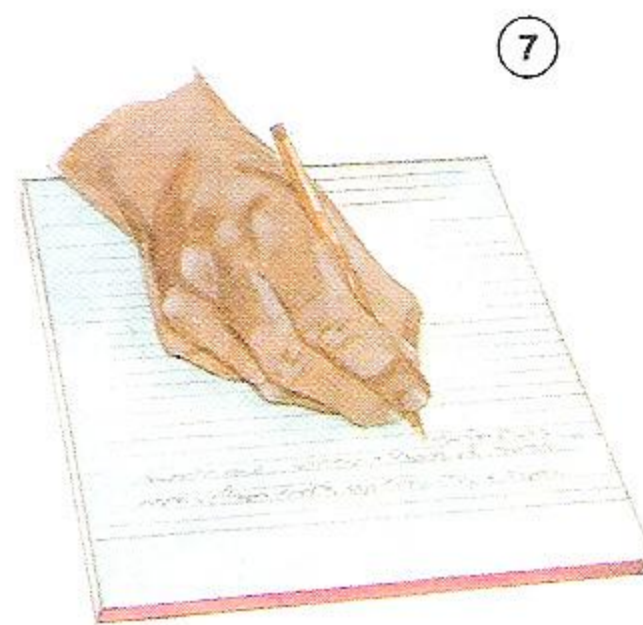

7



8

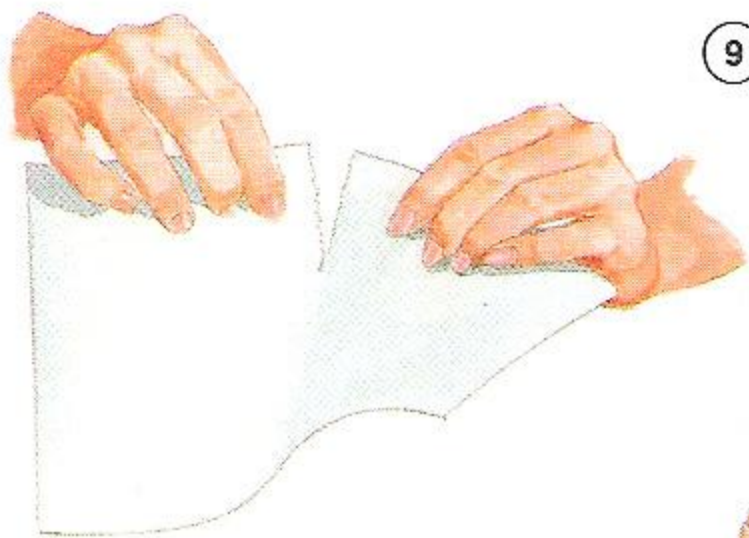

9

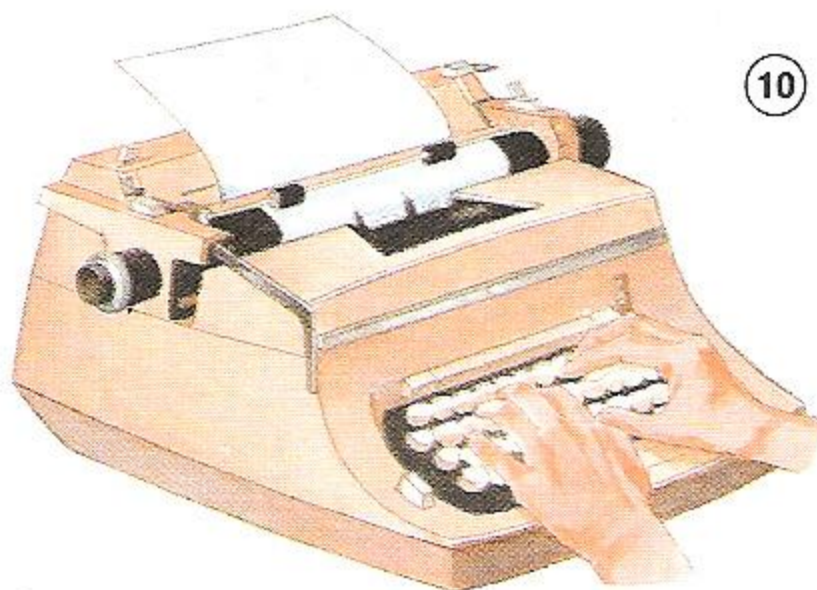

10

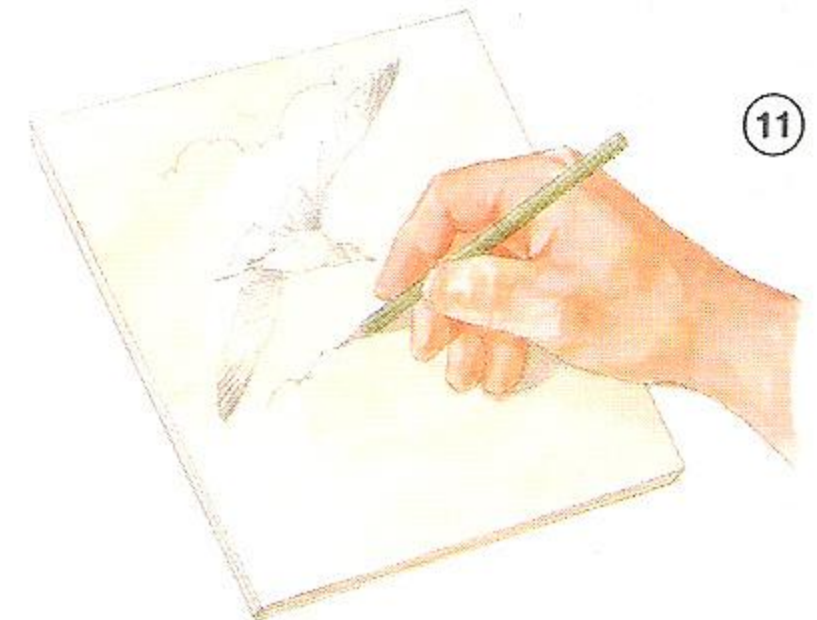

11



12



13



14

- 1. raise (one's hand)
- 2. touch
- 3. erase
- 4. read
- 5. close

- 6. listen
- 7. write
- 8. walk
- 9. tear
- 10. type

- 11. draw
- 12. tie
- 13. leave
- 14. enter

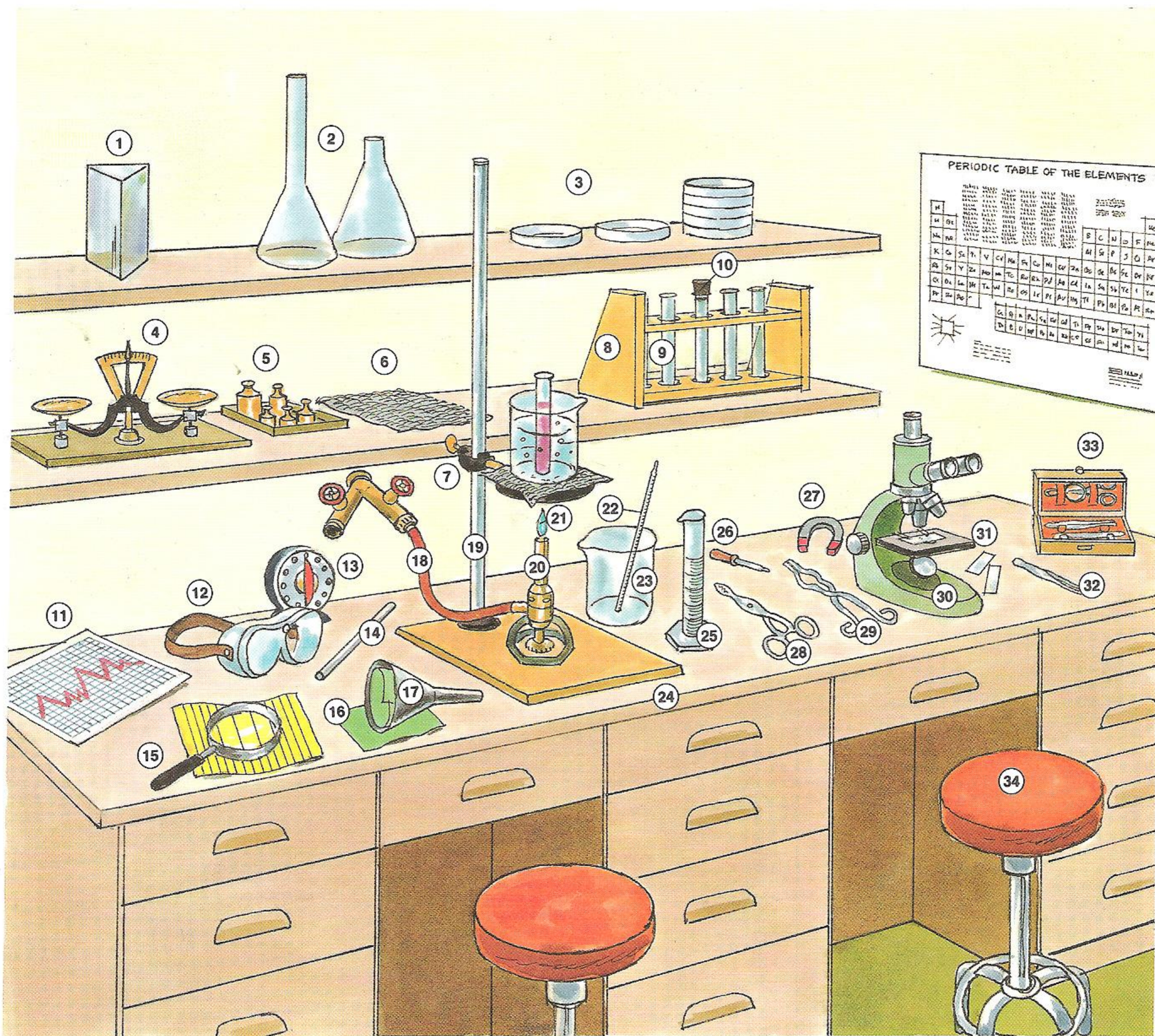

- | | | |
|---------------------|----------------------|------------------------|
| 1. prism | 13. timer | 25. graduated cylinder |
| 2. flask | 14. pipette | 26. medicine dropper |
| 3. petri dish | 15. magnifying glass | 27. magnet |
| 4. scale | 16. filter paper | 28. forceps |
| 5. weights | 17. funnel | 29. tongs |
| 6. wire mesh screen | 18. rubber tubing | 30. microscope |
| 7. clamp | 19. ring stand | 31. slide |
| 8. rack | 20. Bunsen burner | 32. tweezers |
| 9. test tube | 21. flame | 33. dissection kit |
| 10. stopper | 22. thermometer | 34. stool |
| 11. graph paper | 23. beaker | |
| 12. safety glasses | 24. bench | |

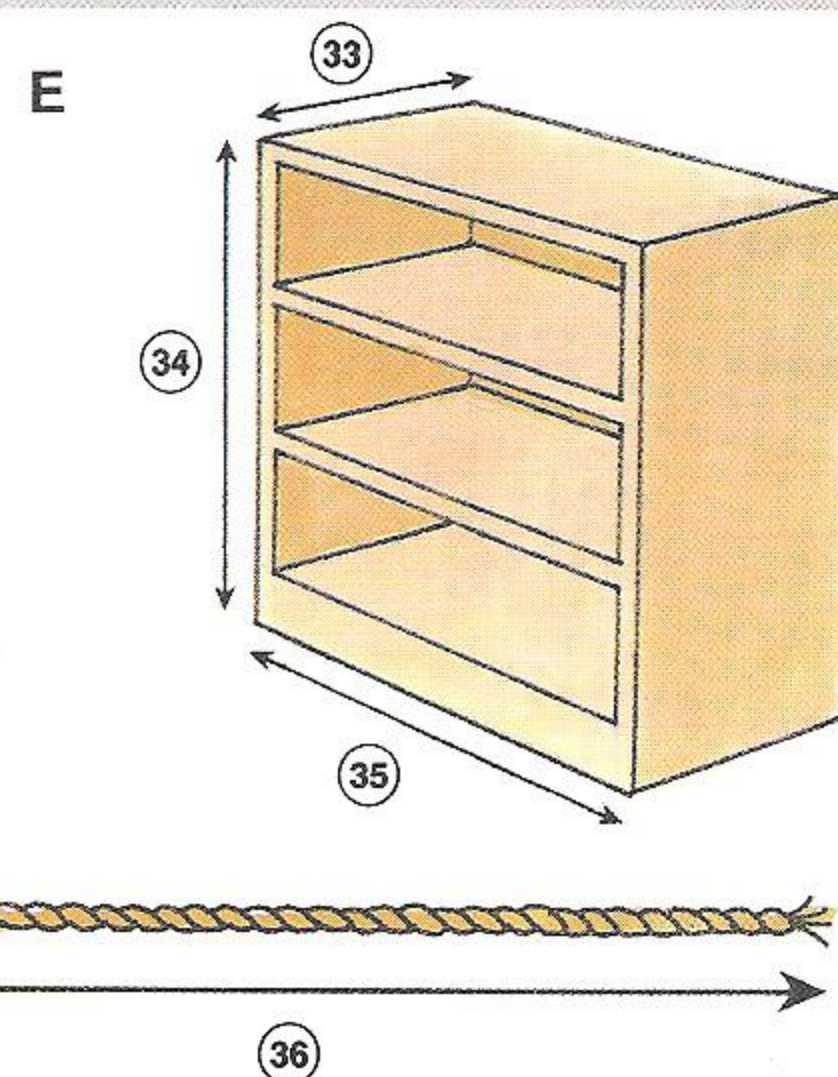
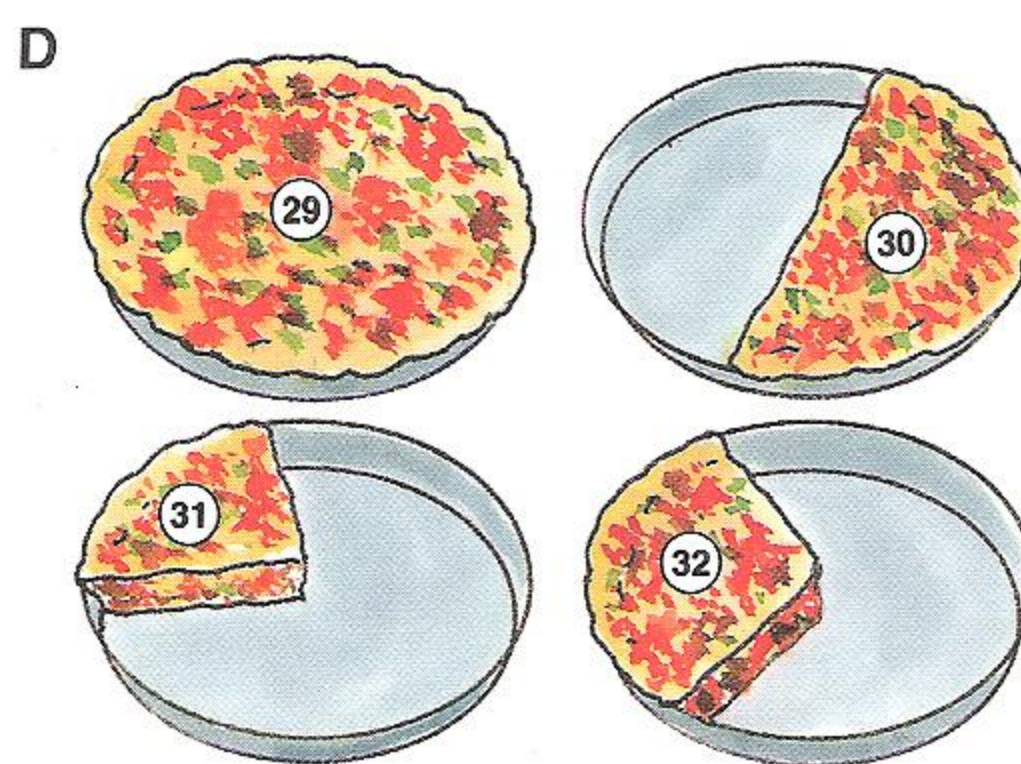
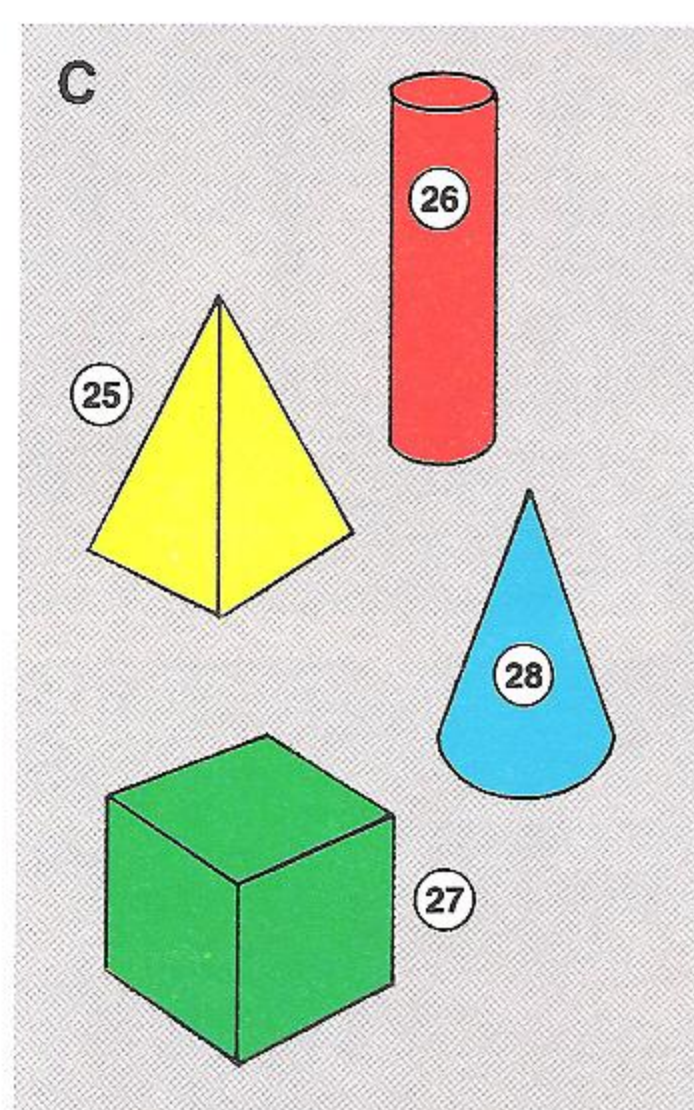
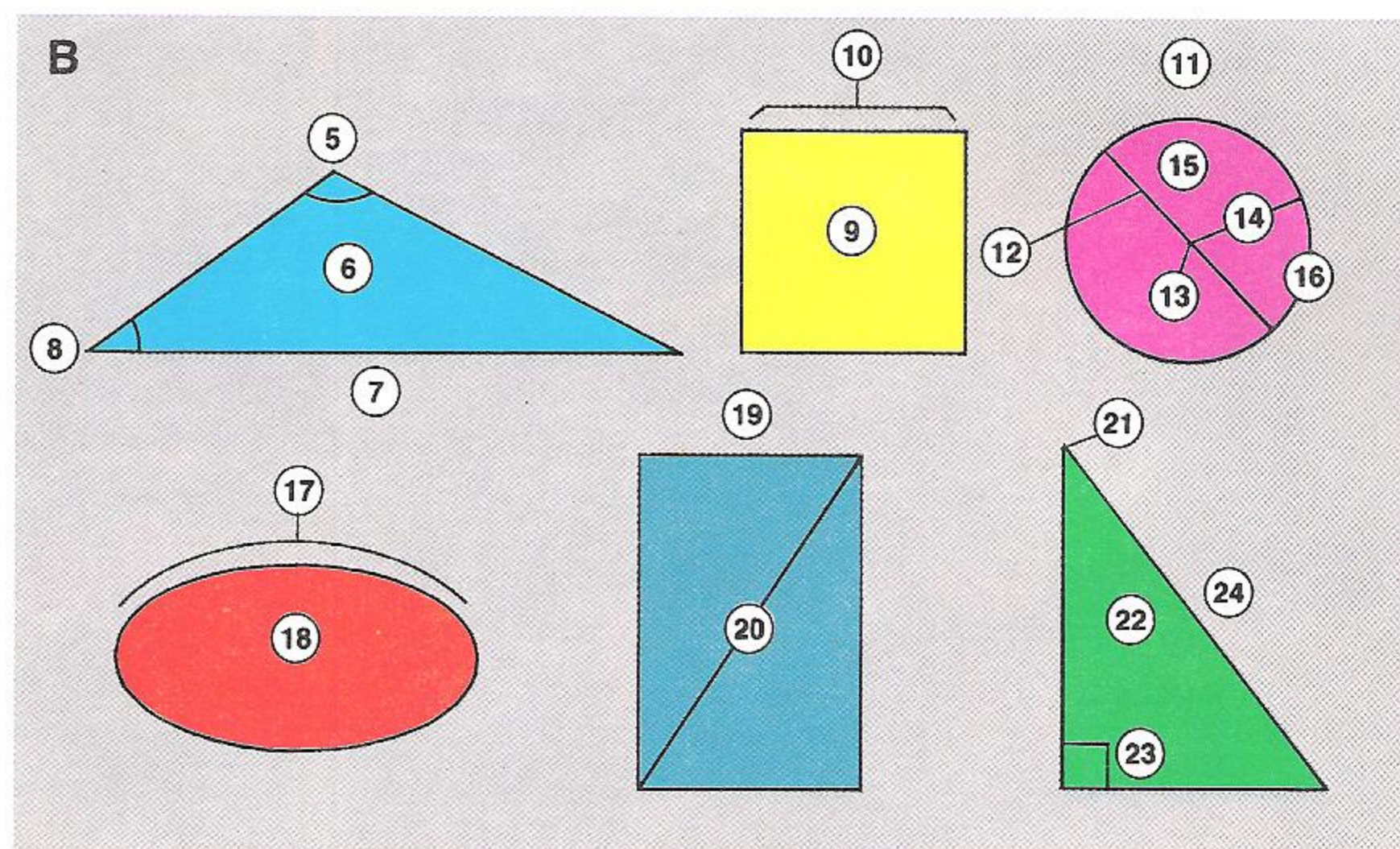
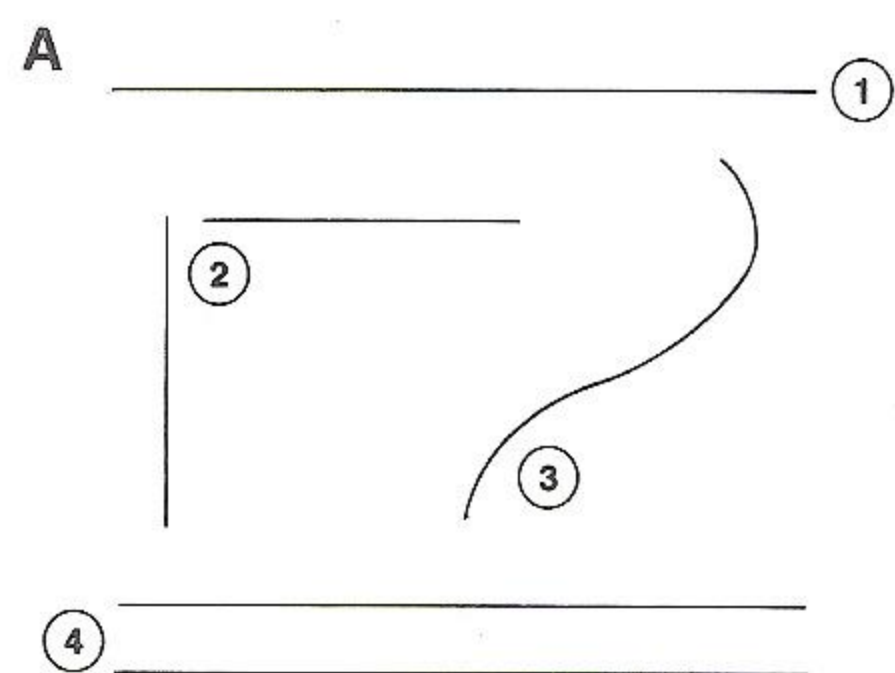

A. Lines

- 1. straight line
- 2. perpendicular lines
- 3. curve
- 4. parallel lines

B. Geometrical Figures

- 5. obtuse angle
- 6. triangle
- 7. base
- 8. acute angle
- 9. square
- 10. side
- 11. circle
- 12. diameter

- 13. center
- 14. radius
- 15. section
- 16. arc
- 17. circumference
- 18. oval
- 19. rectangle
- 20. diagonal
- 21. apex
- 22. right triangle
- 23. right angle
- 24. hypotenuse

C. Solid Figures

- 25. pyramid

- 26. cylinder
- 27. cube
- 28. cone

D. Fractions

- 29. whole
- 30. a half ($\frac{1}{2}$)
- 31. a quarter ($\frac{1}{4}$)
- 32. a third ($\frac{1}{3}$)

E. Measurement

- 33. depth
- 34. height
- 35. width
- 36. length

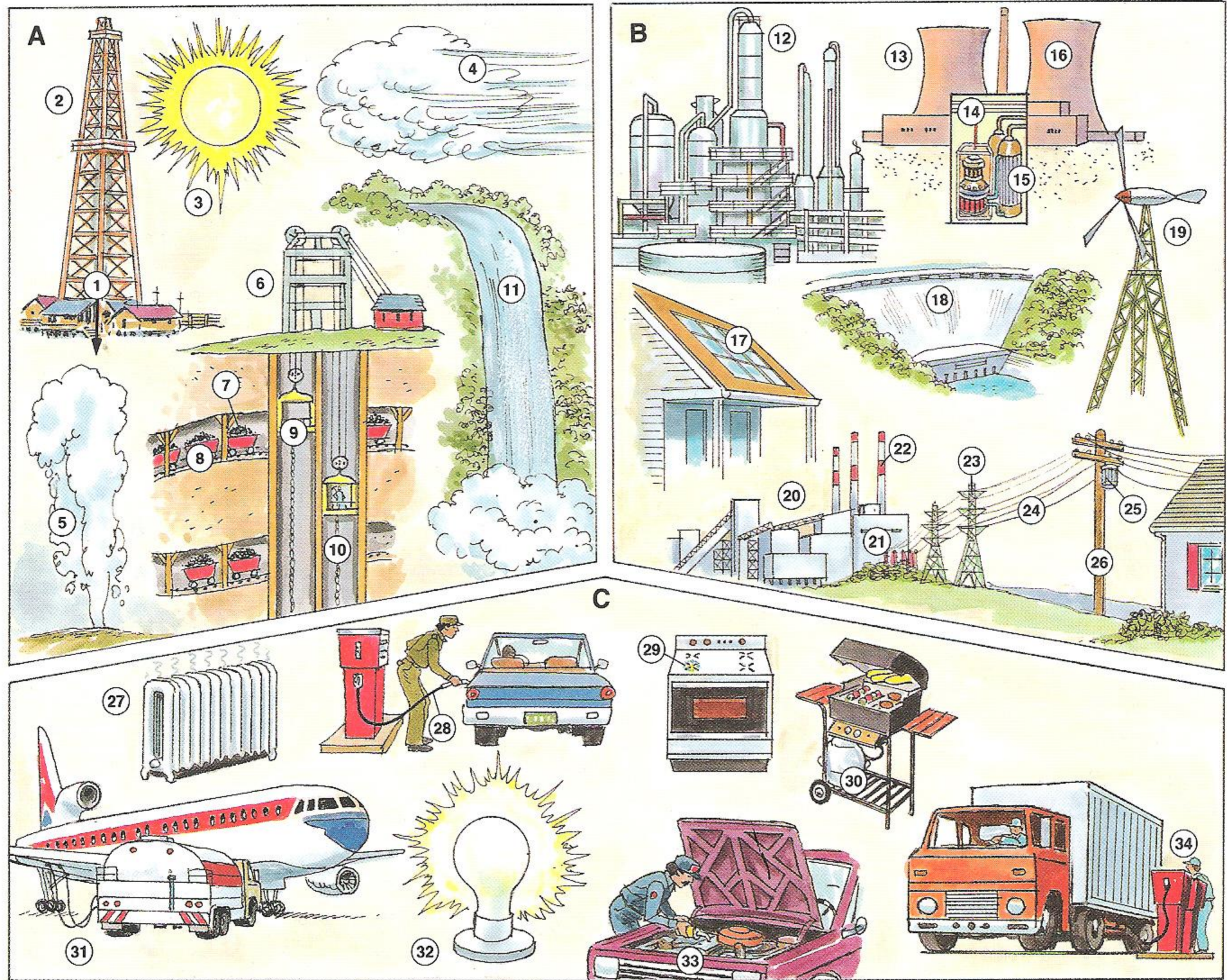

A. Sources of Power

- 1. oil well
- 2. derrick
- 3. sun
- 4. wind
- 5. geyser
- 6. coal mine
- 7. coal
- 8. shuttle car
- 9. elevator
- 10. shaft
- 11. waterfall

B. Generation of Power

- 12. refinery
- 13. nuclear reactor
- 14. core
- 15. uranium rods
- 16. cooling tower
- 17. solar collector
- 18. dam
- 19. windmill
- 20. power station
- 21. electrical generator
- 22. smokestack
- 23. transmission towers

C. Uses and Products

- 24. power lines
- 25. transformer
- 26. utility pole
- 27. heat
- 28. gas(oline)
- 29. natural gas
- 30. propane gas
- 31. jet fuel
- 32. electricity
- 33. motor oil
- 34. diesel fuel

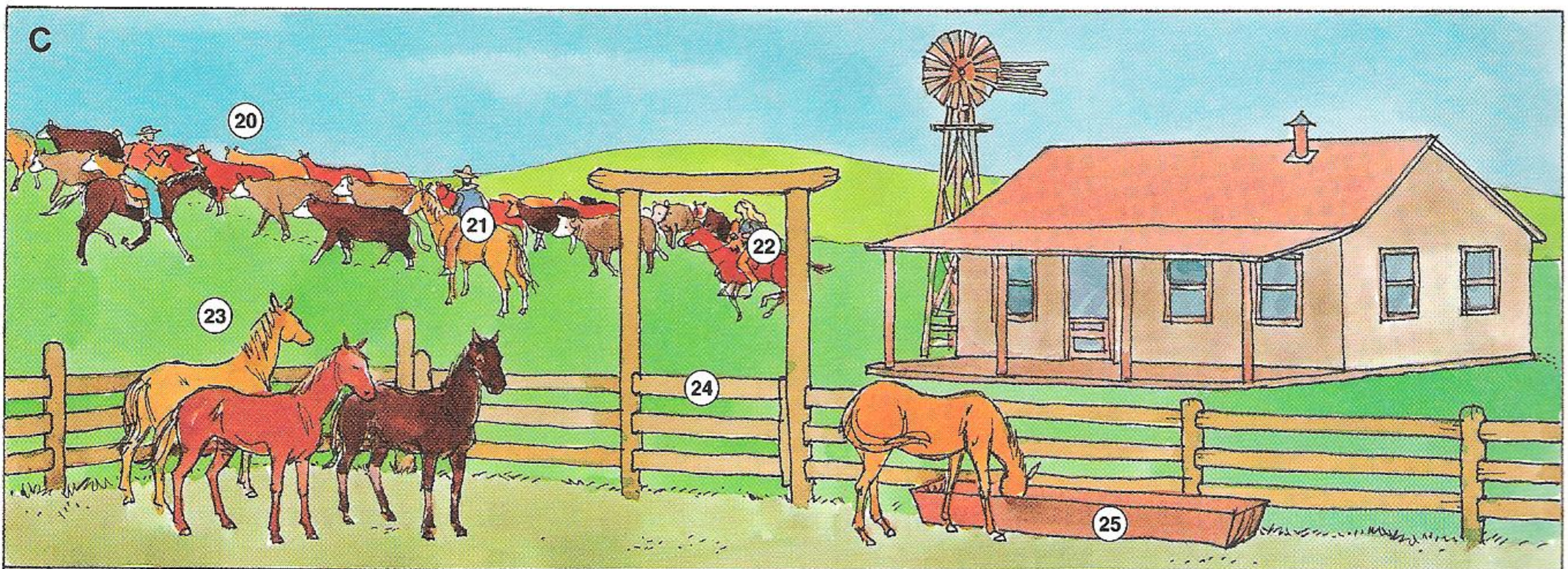
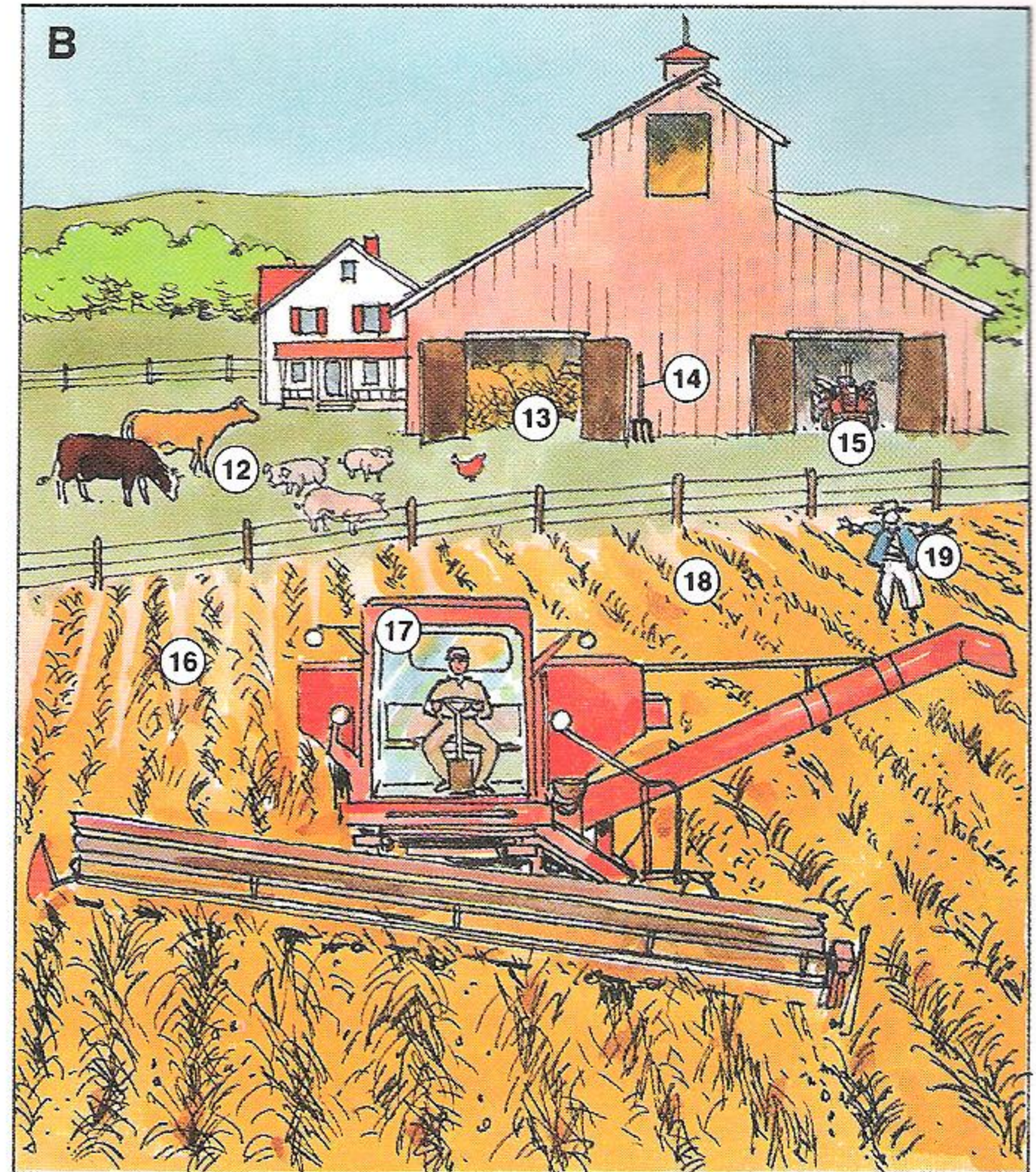
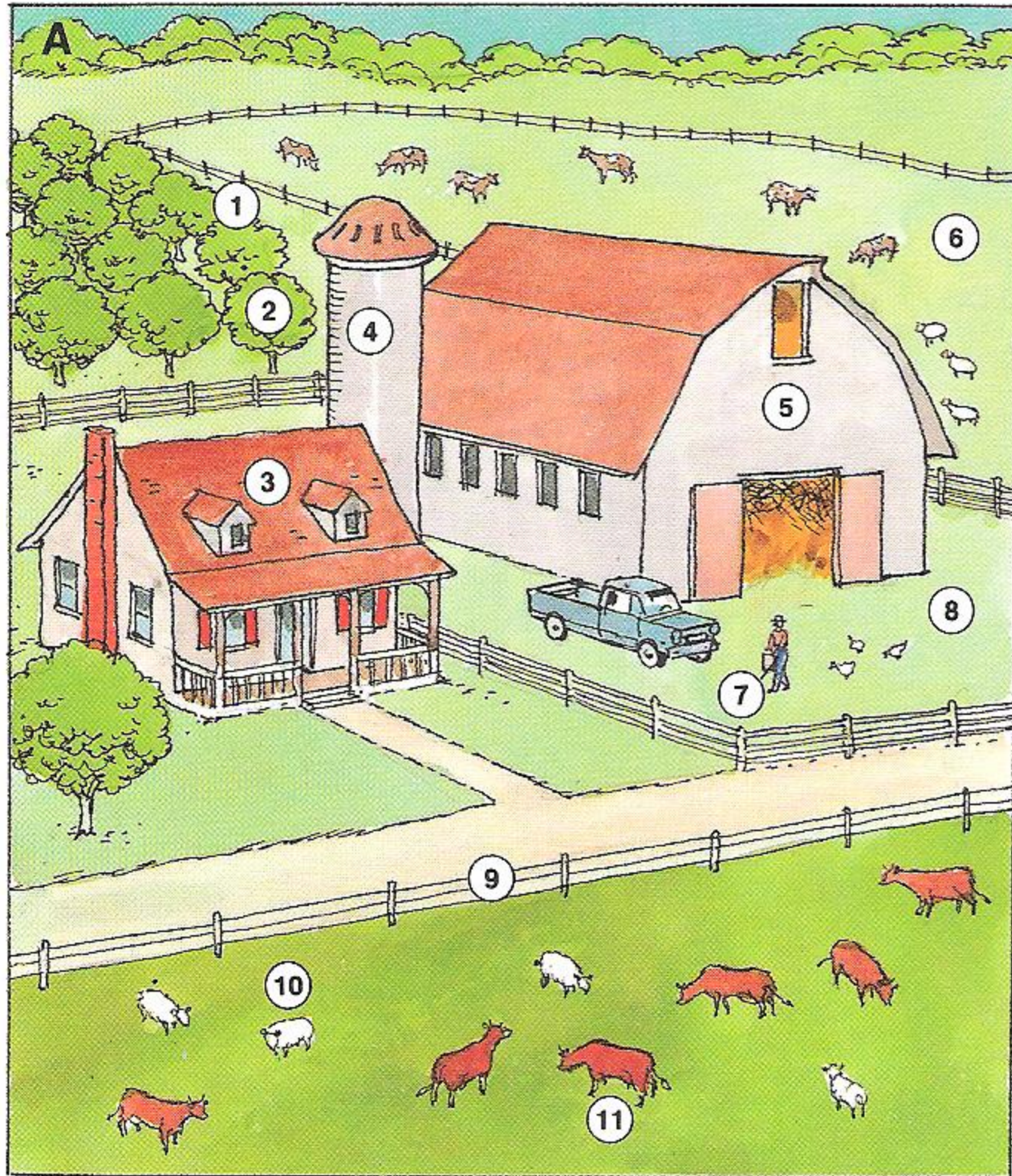

A. Dairy Farm

1. orchard
2. fruit tree
3. farmhouse
4. silo
5. barn
6. pasture
7. farmer
8. barnyard
9. fence

10. sheep
11. dairy cow

B. Wheat Farm

12. livestock
13. (bale of) hay
14. pitchfork
15. tractor
16. (wheat) field
17. combine

18. row
19. scarecrow

C. Ranch

20. (herd of) cattle
21. cowboy
22. cowgirl
23. horses
24. corral
25. trough

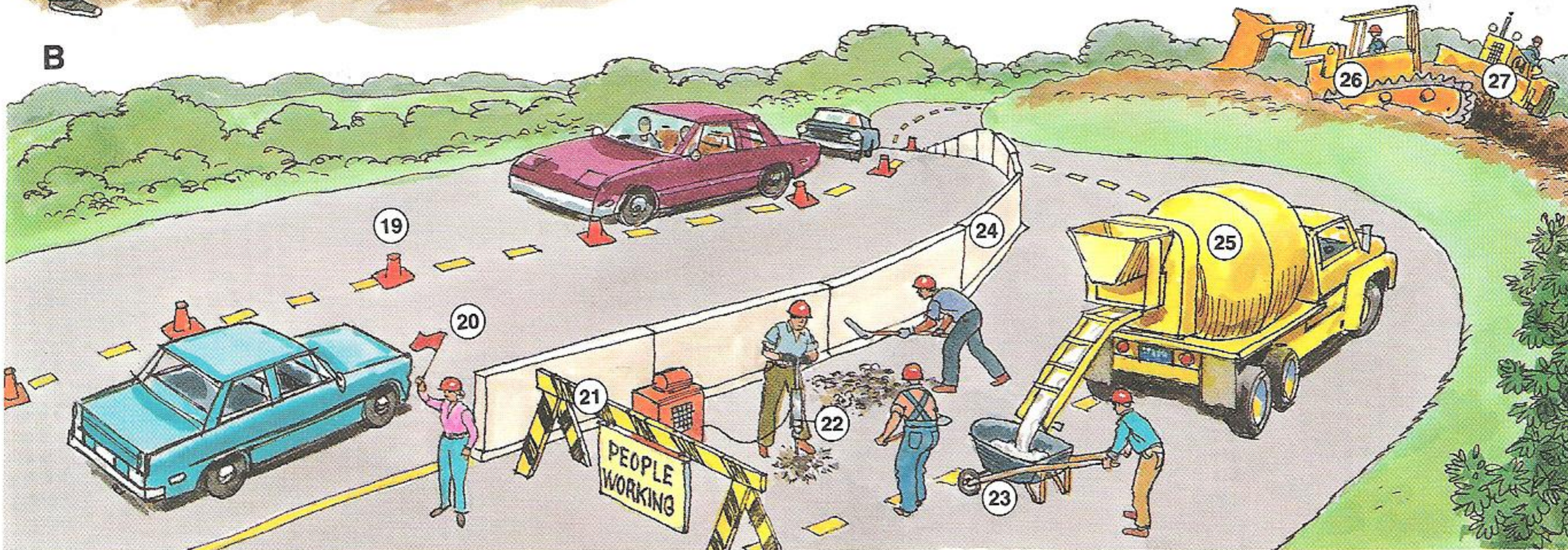
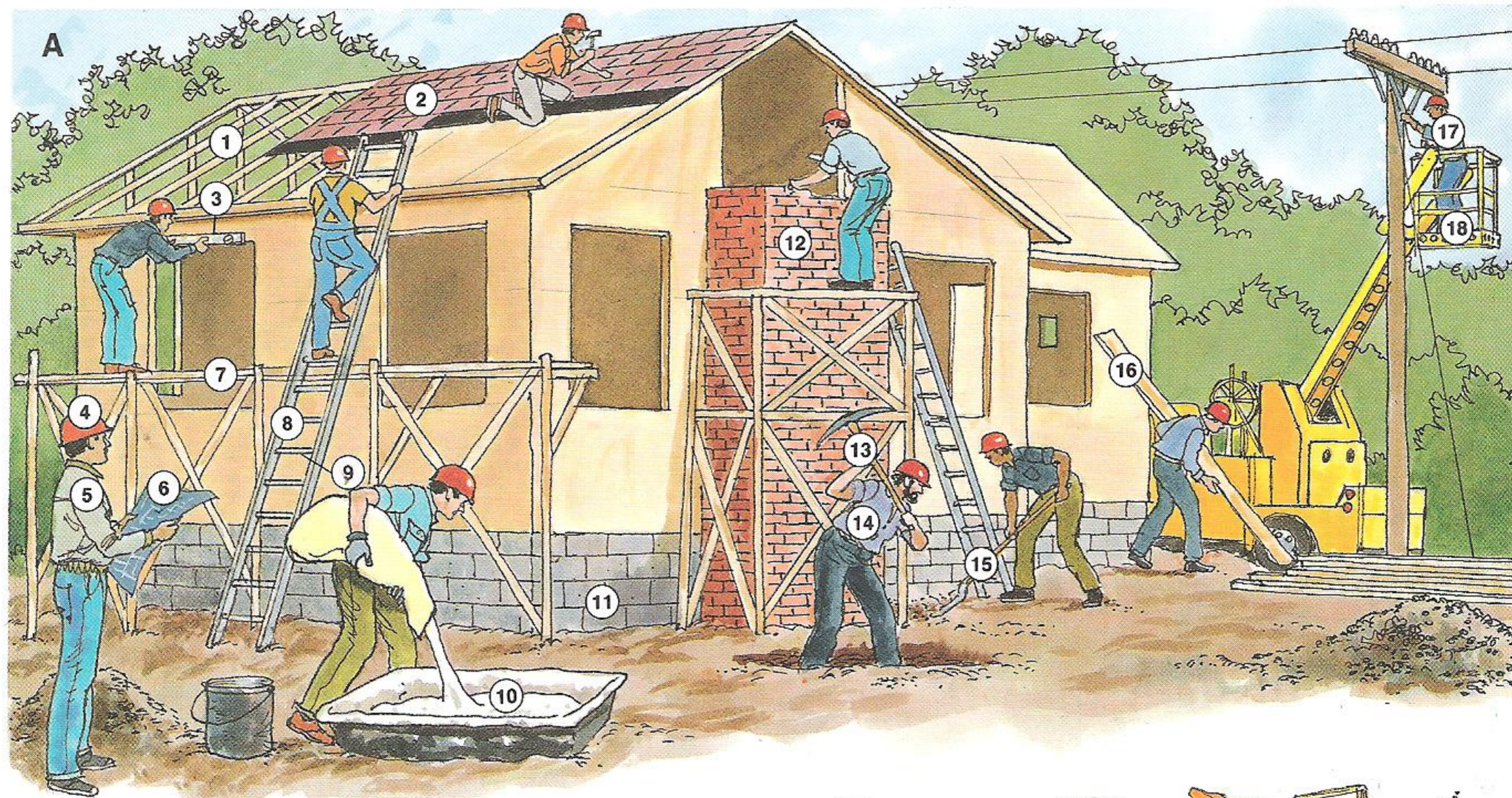

- A. Construction Site**
1. rafters
 2. shingle
 3. level
 4. hard hat
 5. builder
 6. blueprints
 7. scaffolding
 8. ladder
 9. rung
 10. cement

11. foundation
12. bricks
13. pickaxe
14. construction worker
15. shovel
16. board
17. linesman
18. cherry picker

- B. Road Work**
19. cone
 20. flag
 21. barricade
 22. jackhammer
 23. wheelbarrow
 24. center divider
 25. cement mixer
 26. backhoe
 27. bulldozer

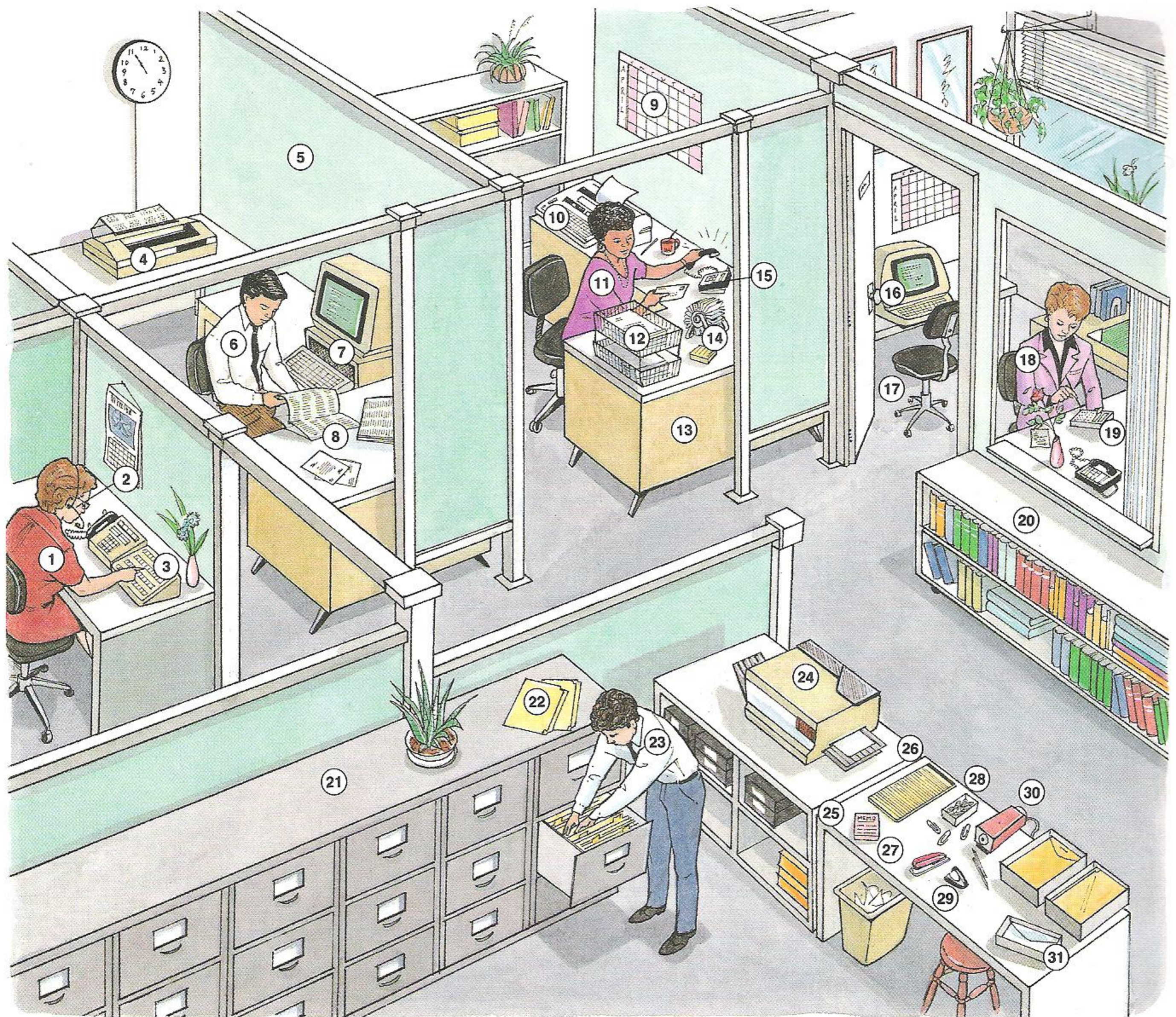

- | | | |
|-------------------------|------------------|----------------------|
| 1. switchboard operator | 12. in-box | 23. file clerk |
| 2. headset | 13. desk | 24. photocopier |
| 3. switchboard | 14. rolodex | 25. message pad |
| 4. printer | 15. telephone | 26. (legal) pad |
| 5. cubicle | 16. computer | 27. stapler |
| 6. typist | 17. typing chair | 28. paper clips |
| 7. word processor | 18. manager | 29. staple remover |
| 8. printout | 19. calculator | 30. pencil sharpener |
| 9. calendar | 20. bookcase | 31. envelope |
| 10. typewriter | 21. file cabinet | |
| 11. secretary | 22. file folder | |



- 1. pharmacist
- 2. mechanic
- 3. barber
- 4. travel agent
- 5. repairperson

- 6. tailor
- 7. greengrocer
- 8. baker
- 9. optician
- 10. hairdresser

- 11. florist
- 12. jeweller
- 13. butcher

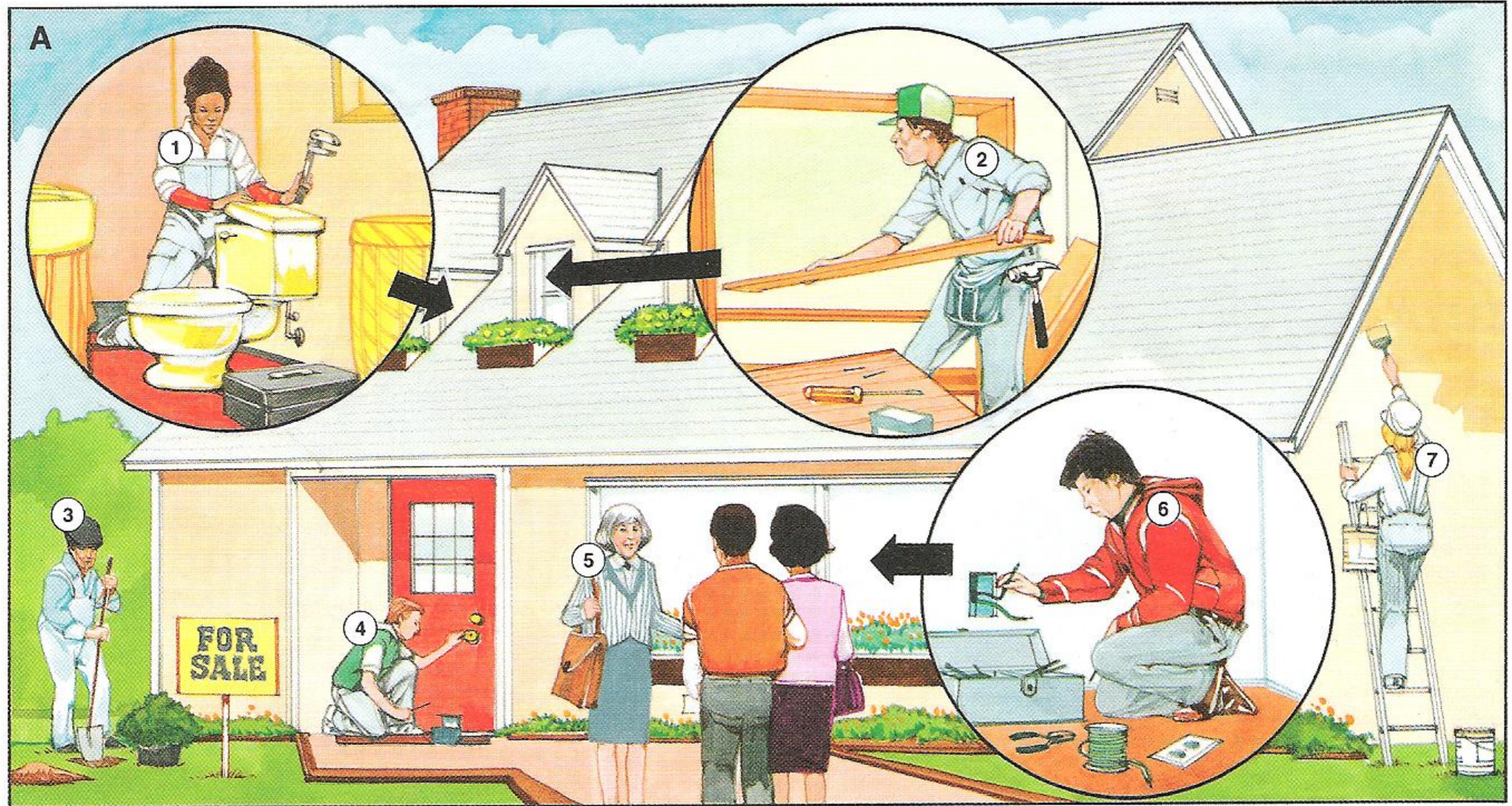

A. Repair and Maintenance

1. plumber
2. carpenter
3. gardener
4. locksmith
5. real estate agent
6. electrician
7. painter

B. Household Services

8. housekeeper
9. janitor
10. delivery boy
11. doorman

C. Factory Work

12. shop worker
13. foreman

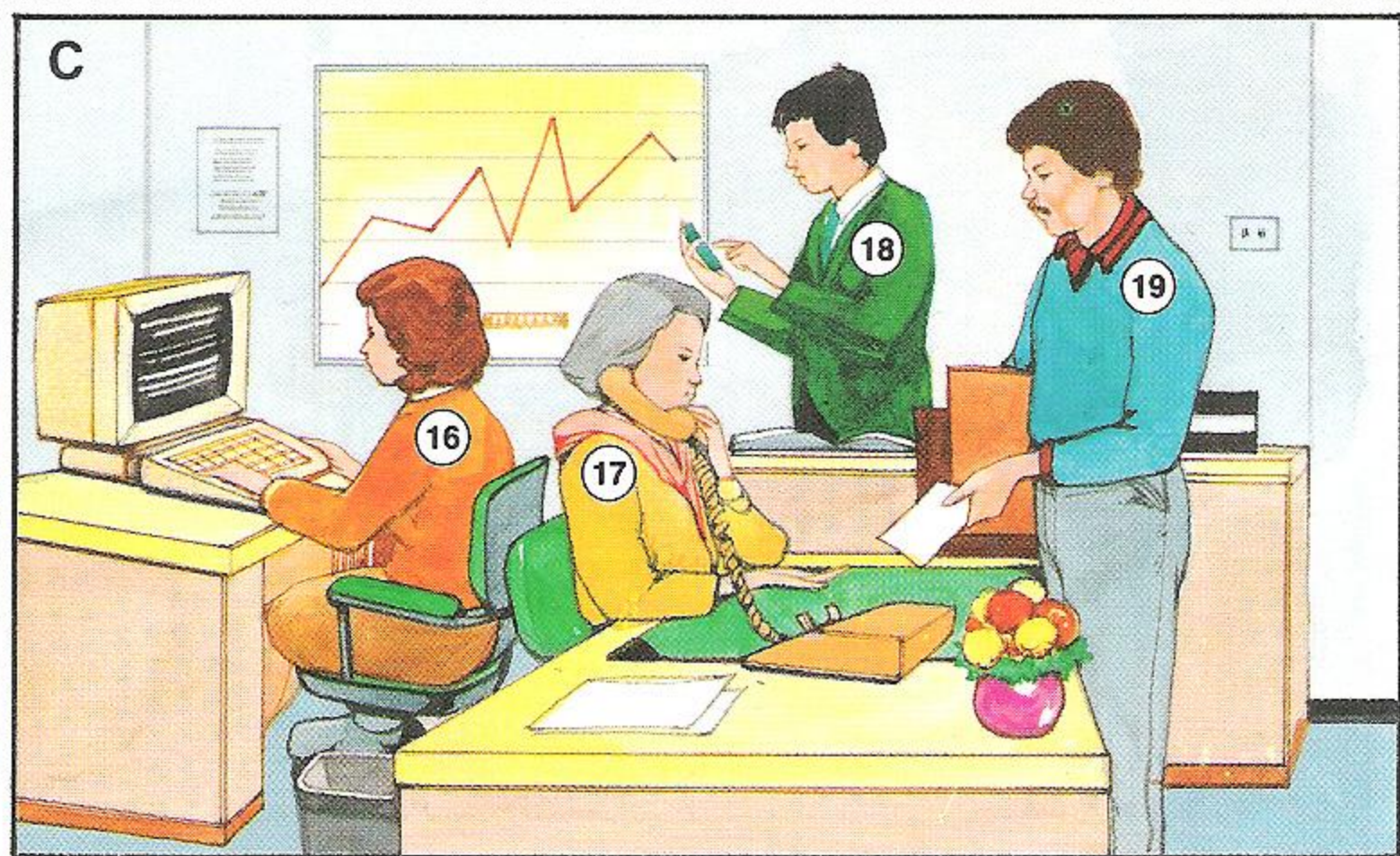
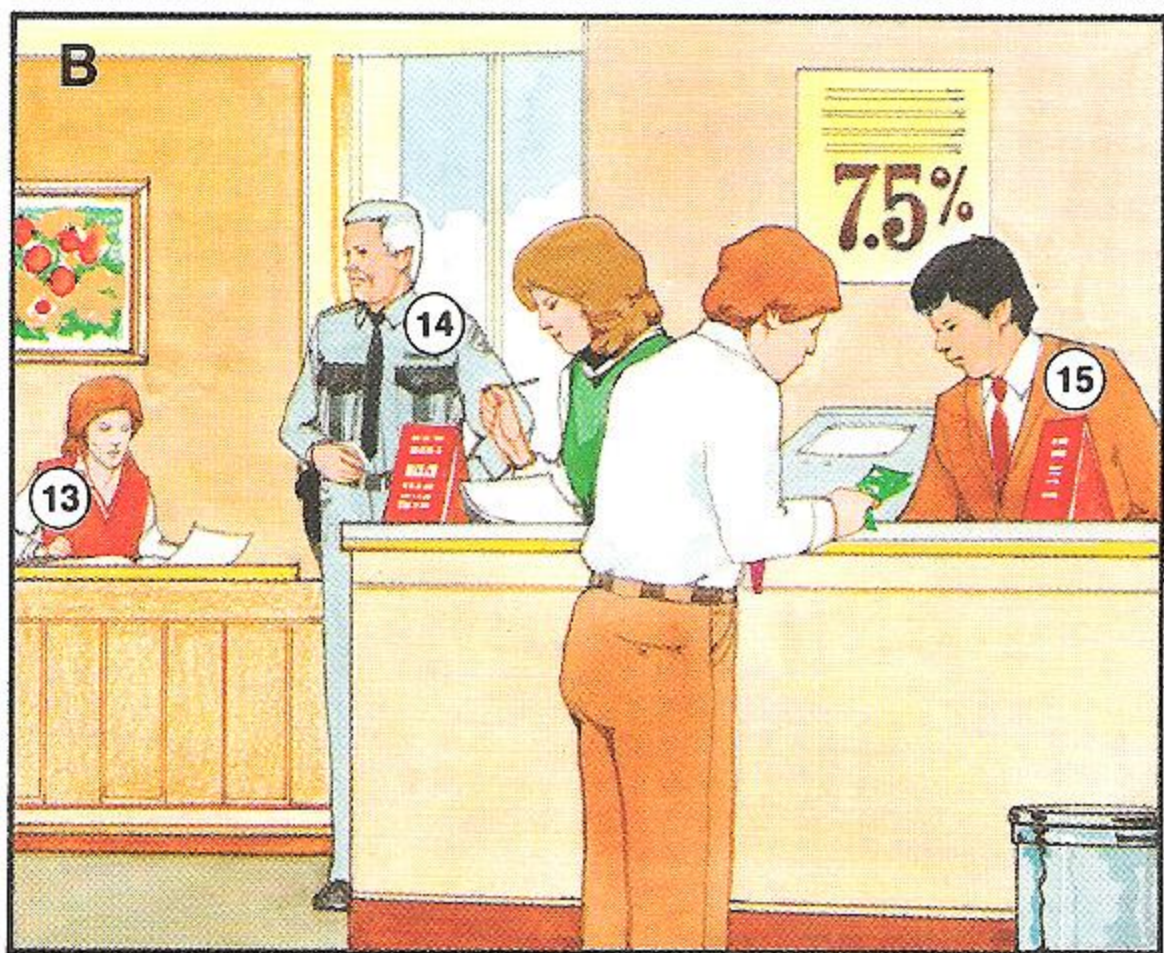

A. Media and Arts

- 1. weather forecaster
- 2. newscaster
- 3. artist
- 4. photographer
- 5. model
- 6. fashion designer
- 7. writer

8. architect

- 9. disc jockey (DJ)
- 10. cameraperson
- 11. reporter
- 12. salesperson

B. Banking

- 13. officer

14. security guard

- 15. teller

C. Business Workers

- 16. computer programmer
- 17. receptionist
- 18. accountant
- 19. messenger



- | | | |
|--------------------|-----------------|--------------------|
| 1. zoo | 8. (duck) pond | 15. playground |
| 2. band shell | 9. jogging path | 16. swings |
| 3. vendor | 10. bench | 17. jungle gym |
| 4. hand truck | 11. trash can | 18. seesaw |
| 5. merry-go-round | 12. slide | 19. water fountain |
| 6. horseback rider | 13. sandbox | |
| 7. bridle path | 14. sprinkler | |

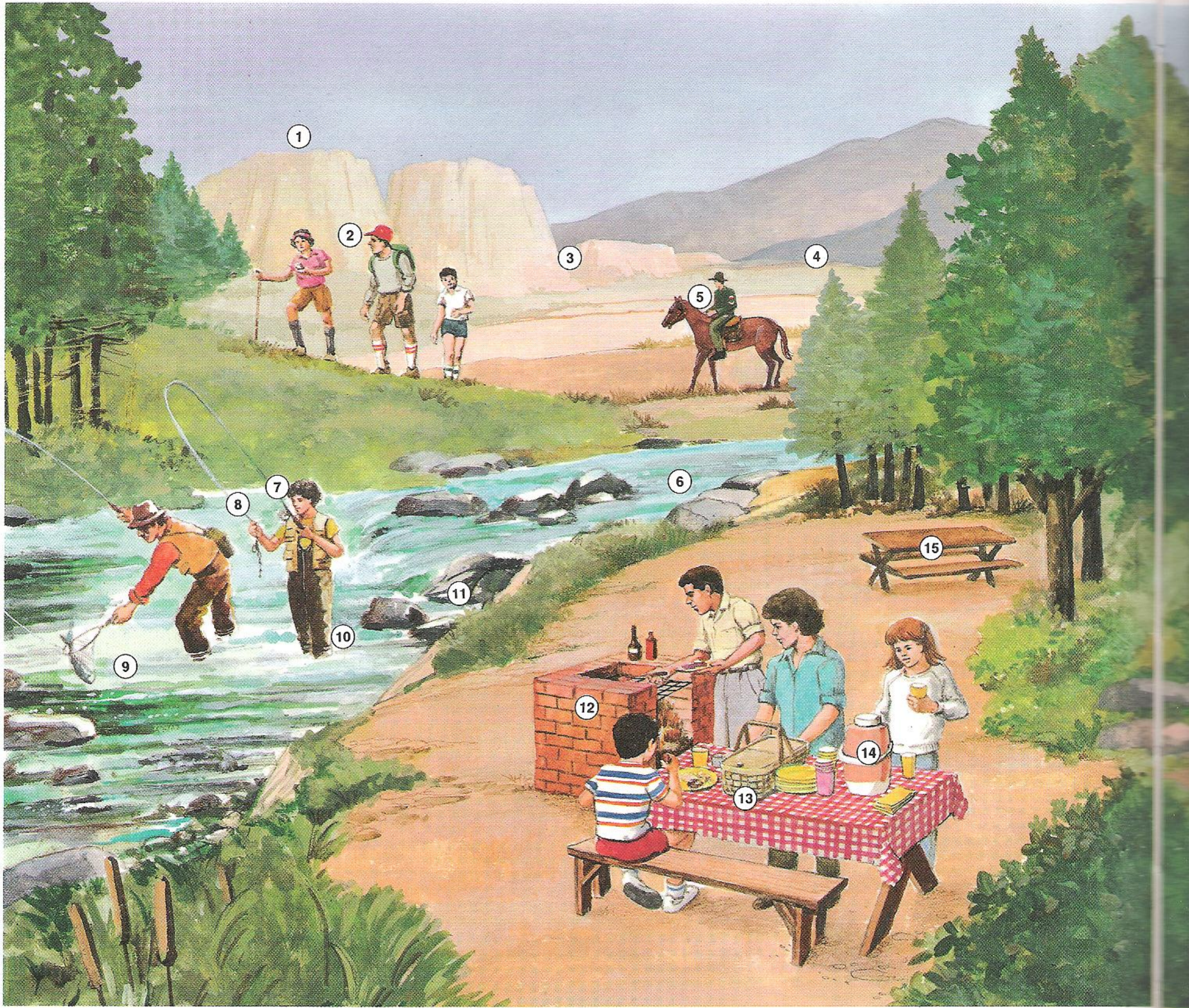

- 1. plateau
- 2. hikers
- 3. canyon
- 4. hill
- 5. park ranger

- Fishing**
- 6. stream
 - 7. fishing rod
 - 8. fishing line
 - 9. fishing net
 - 10. waders
 - 11. rocks

- Picnic Area**
- 12. grill
 - 13. picnic basket
 - 14. thermos
 - 15. picnic table

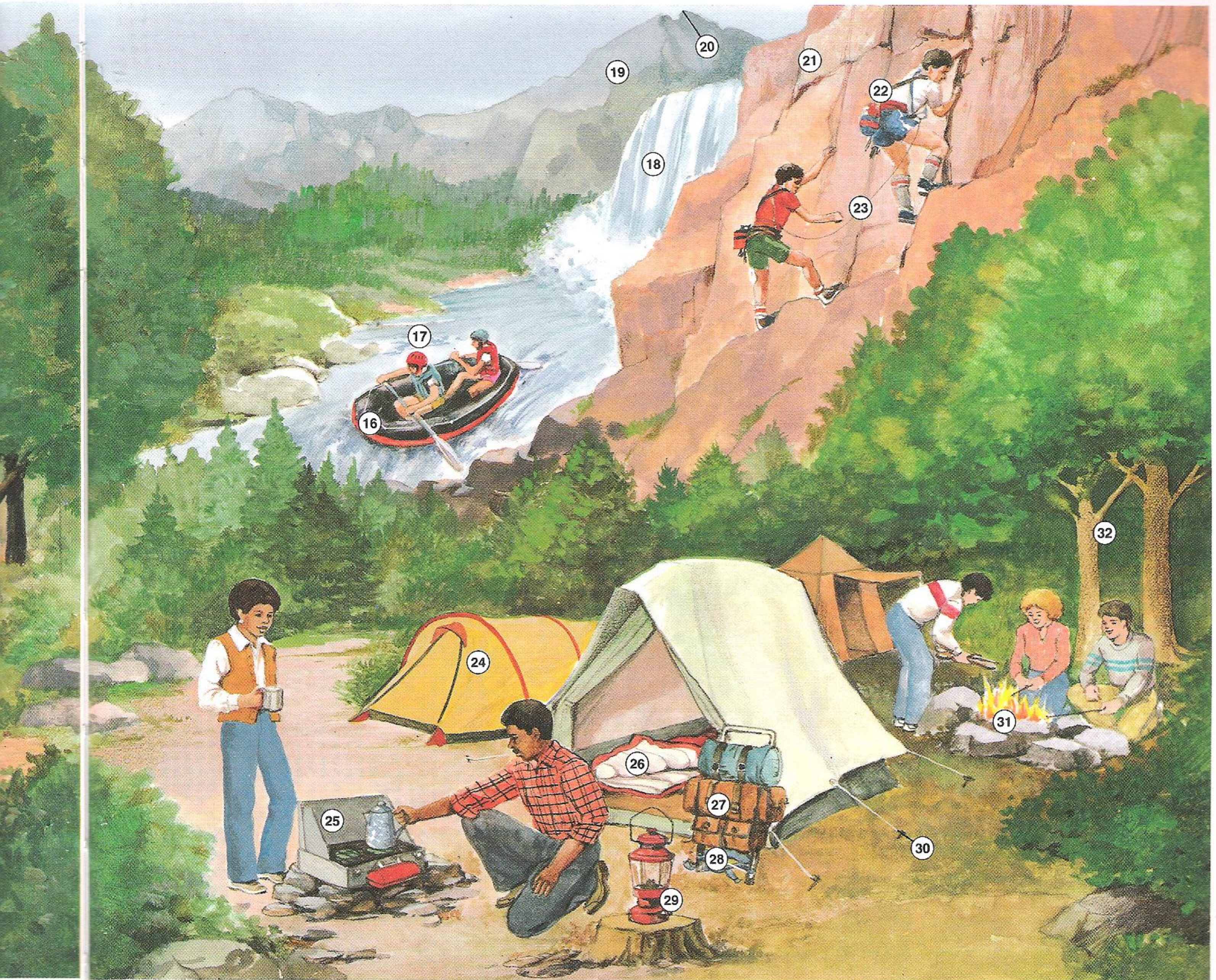

- Rafting**
- 16. raft
 - 17. rapids
 - 18. waterfall

- Mountain Climbing**
- 19. mountain
 - 20. peak
 - 21. cliff
 - 22. harness
 - 23. rope

- Camping**
- 24. tent
 - 25. camp stove
 - 26. sleeping bag
 - 27. gear
 - 28. frame backpack
 - 29. lantern
 - 30. stake
 - 31. campfire
 - 32. woods

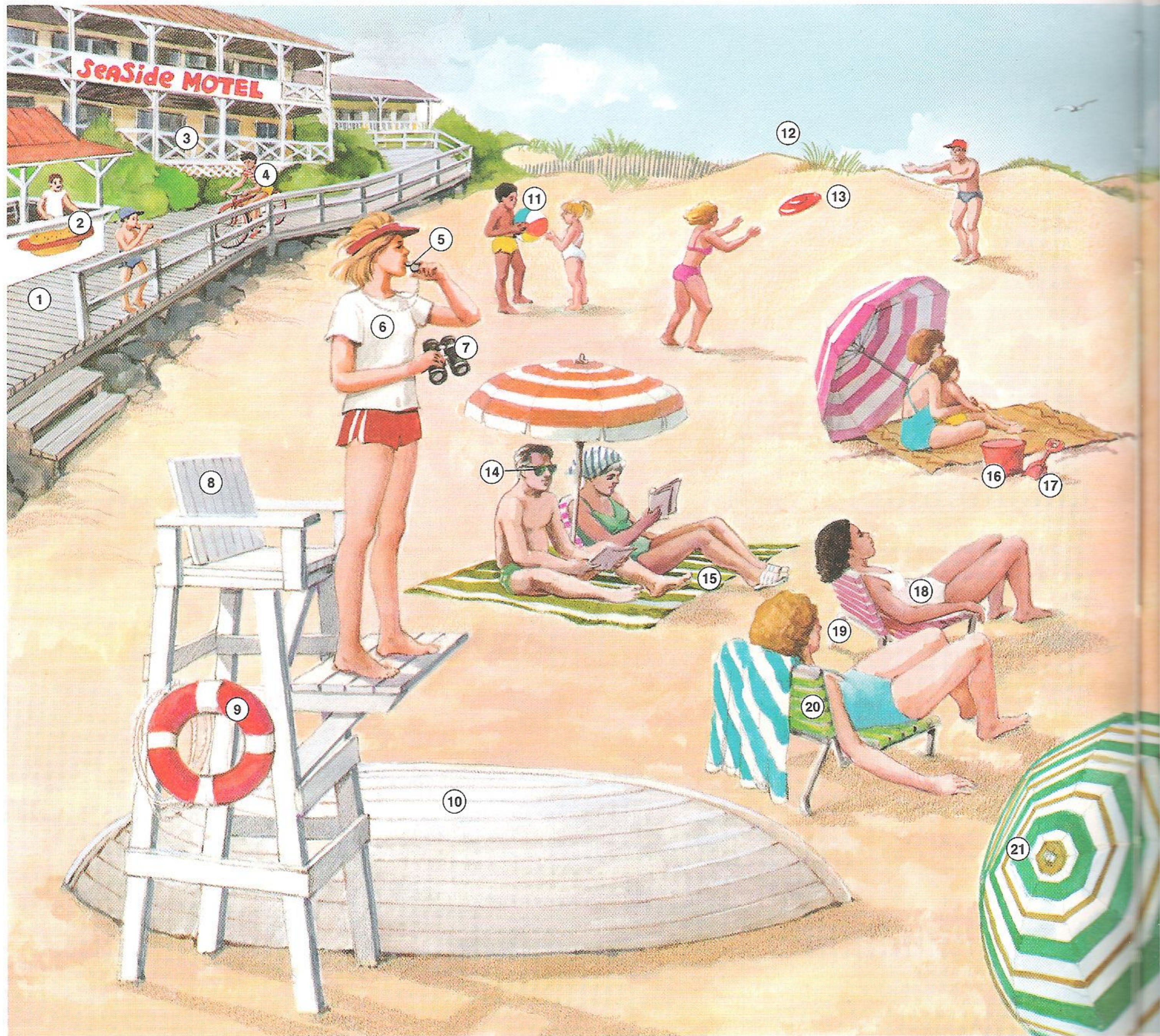

- | | | |
|----------------------|--------------------|--------------------|
| 1. boardwalk | 8. lifeguard chair | 15. beach towel |
| 2. refreshment stand | 9. life preserver | 16. pail |
| 3. motel | 10. lifeboat | 17. shovel |
| 4. biker | 11. beach ball | 18. bathing suit |
| 5. whistle | 12. sand dunes | 19. sunbather |
| 6. lifeguard | 13. Frisbee™ | 20. beach chair |
| 7. binoculars | 14. sunglasses | 21. beach umbrella |

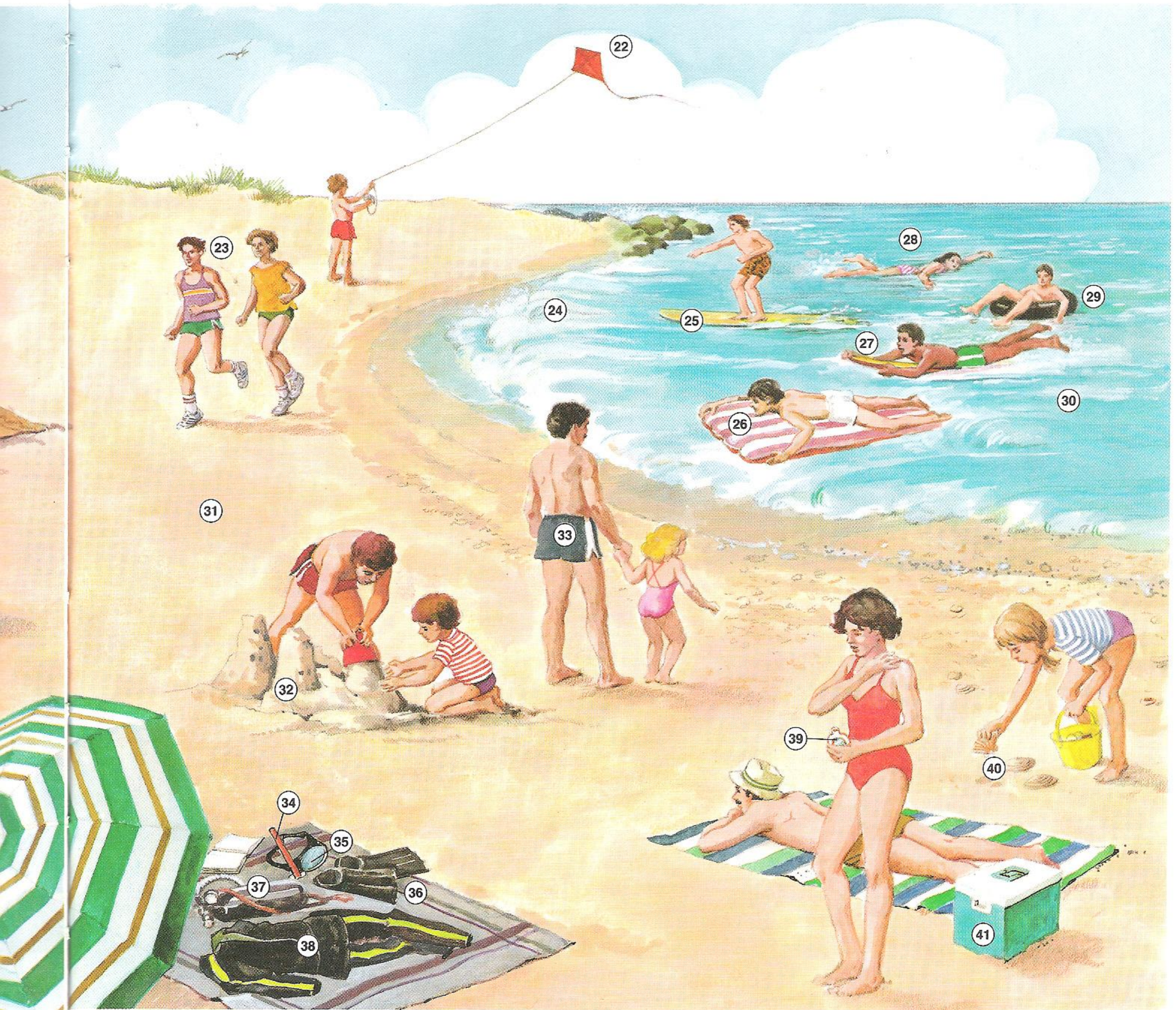

- | | | |
|------------------|--------------------|-------------------|
| 22. kite | 29. tube | 36. flippers |
| 23. runners | 30. water | 37. scuba tank |
| 24. wave | 31. sand | 38. wet suit |
| 25. surfboard | 32. sandcastle | 39. suntan lotion |
| 26. air mattress | 33. bathing trunks | 40. shell |
| 27. kickboard | 34. snorkel | 41. cooler |
| 28. swimmer | 35. mask | |

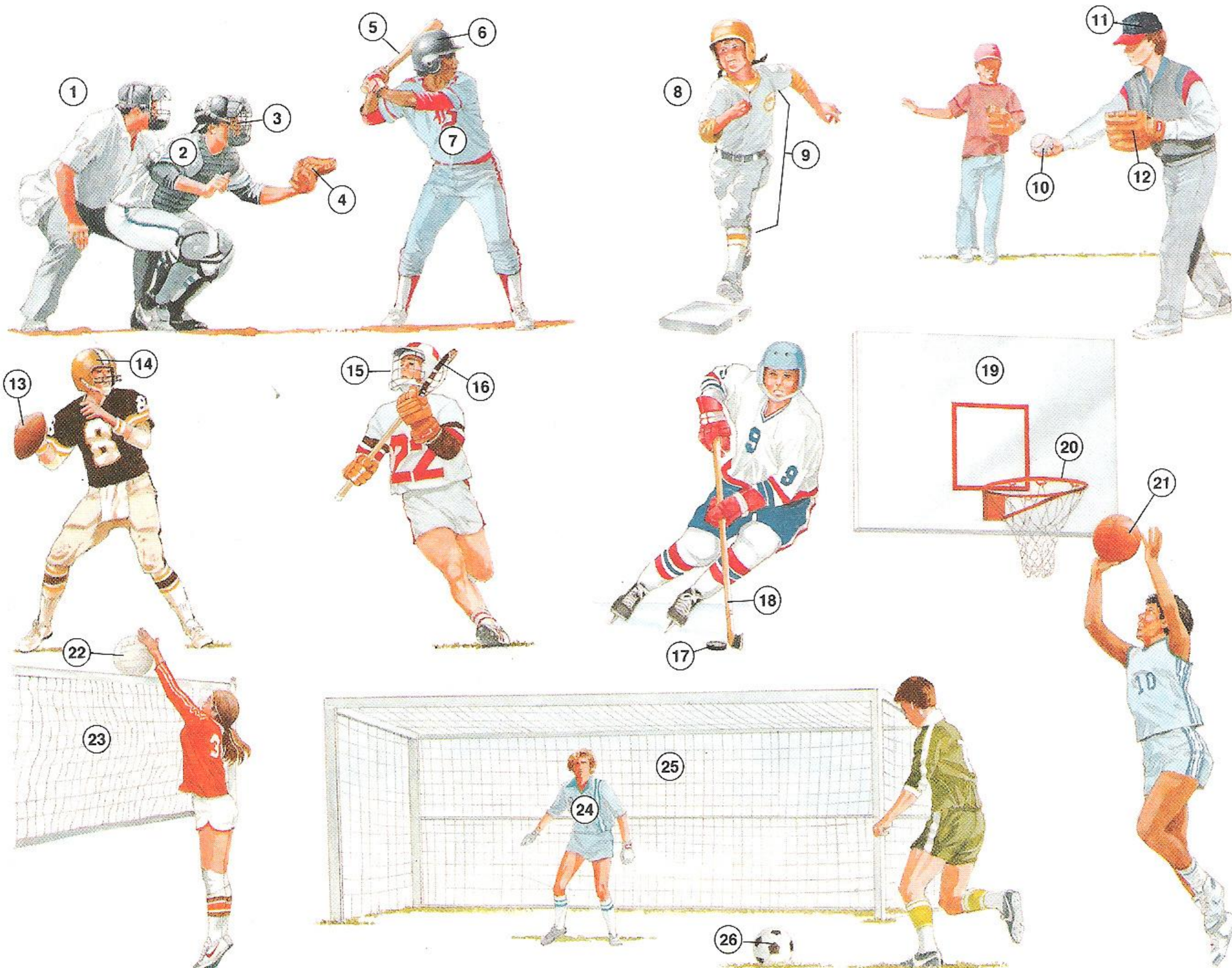

Baseball

- 1. umpire
- 2. catcher
- 3. catcher's mask
- 4. catcher's mitt
- 5. bat
- 6. batting helmet
- 7. batter

Little League Baseball

- 8. Little Leaguer
- 9. uniform

Softball

- 10. softball
- 11. cap
- 12. glove

Football

- 13. football
- 14. helmet

Lacrosse

- 15. face guard
- 16. lacrosse stick

Ice Hockey

- 17. puck
- 18. hockey stick

Basketball

- 19. backboard
- 20. basket
- 21. basketball

Volleyball

- 22. volleyball net
- 23. net

Soccer

- 24. goalie
- 25. goal
- 26. soccer ball

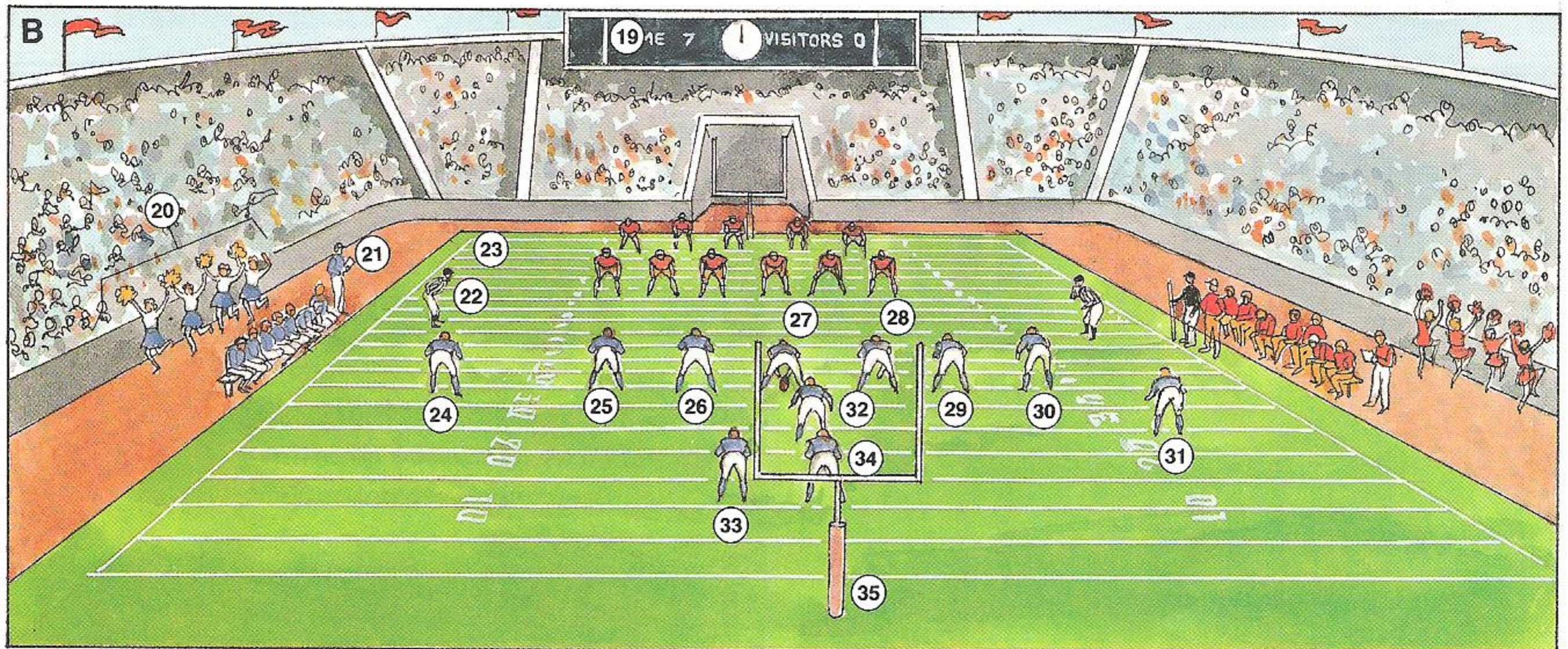
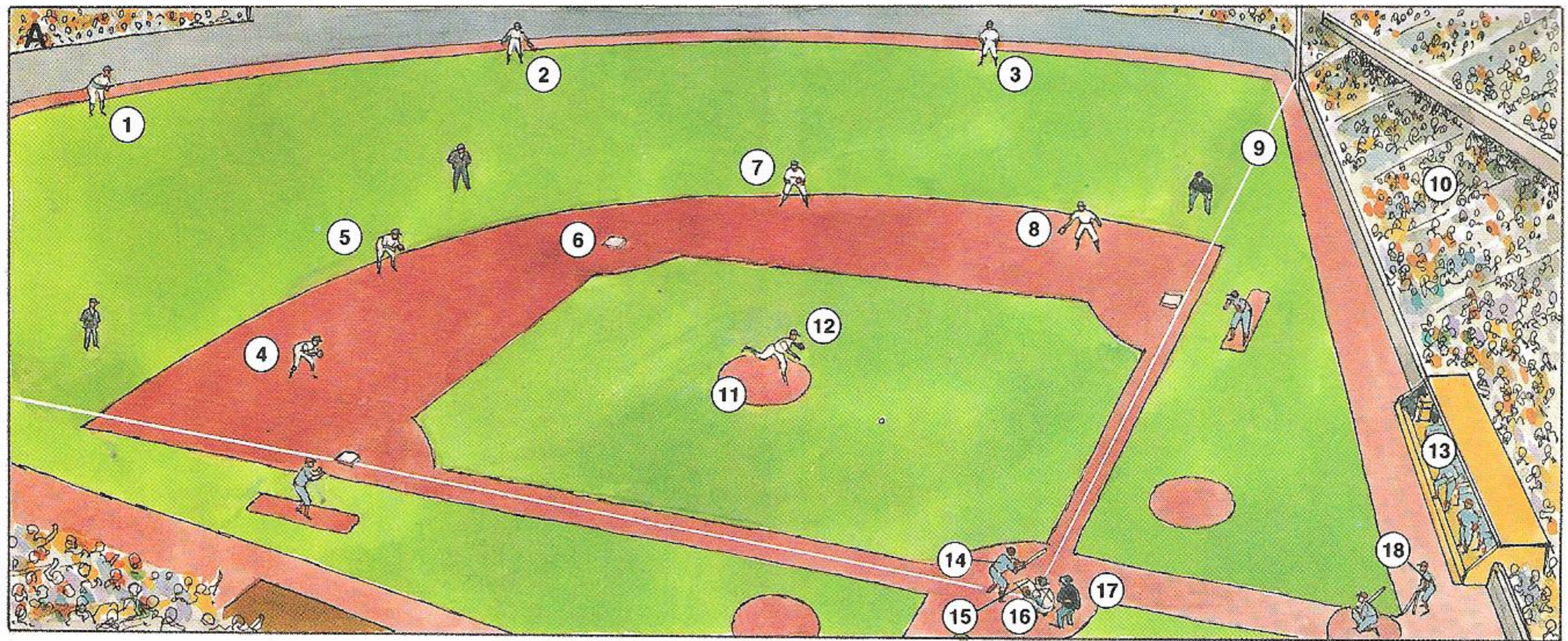

- A. Baseball Diamond**
1. left fielder
 2. center fielder
 3. right fielder
 4. third baseman
 5. shortstop
 6. base
 7. second baseman
 8. first baseman
 9. foul line
 10. stands
 11. pitcher's mound
 12. pitcher

13. dugout
14. batter
15. home plate
16. catcher
17. umpire
18. batboy

- B. Football Field**
19. scoreboard
 20. cheerleaders
 21. coach
 22. referee
 23. end zone

24. split end
25. left tackle
26. left guard
27. center
28. right guard
29. right tackle
30. tight end
31. flanker
32. quarterback
33. halfback
34. fullback
35. goalpost



Tennis

- 1. tennis ball
- 2. racket

Bowling

- 3. gutter
- 4. lane
- 5. pin
- 6. bowling ball

Golf

- 7. golf ball
- 8. hole
- 9. putter
- 10. golfer

Handball

- 11. glove
- 12. handball
- 13. court

Boxing

- 14. head protector
- 15. glove
- 16. referee
- 17. ring

Ping-Pong

- 18. paddle
- 19. ping-pong ball

Horse Racing

- 20. saddle
- 21. jockey
- 22. reins

Gymnastics

- 23. gymnast
- 24. balance beam

Ice Skating

- 25. rink
- 26. skate
- 27. blade

Racquetball

- 28. safety goggles
- 29. racquet
- 30. racquetball

Track and Field

- 31. runner
- 32. track

Cross-Country Skiing

- 33. skis
- 34. pole
- 35. skier

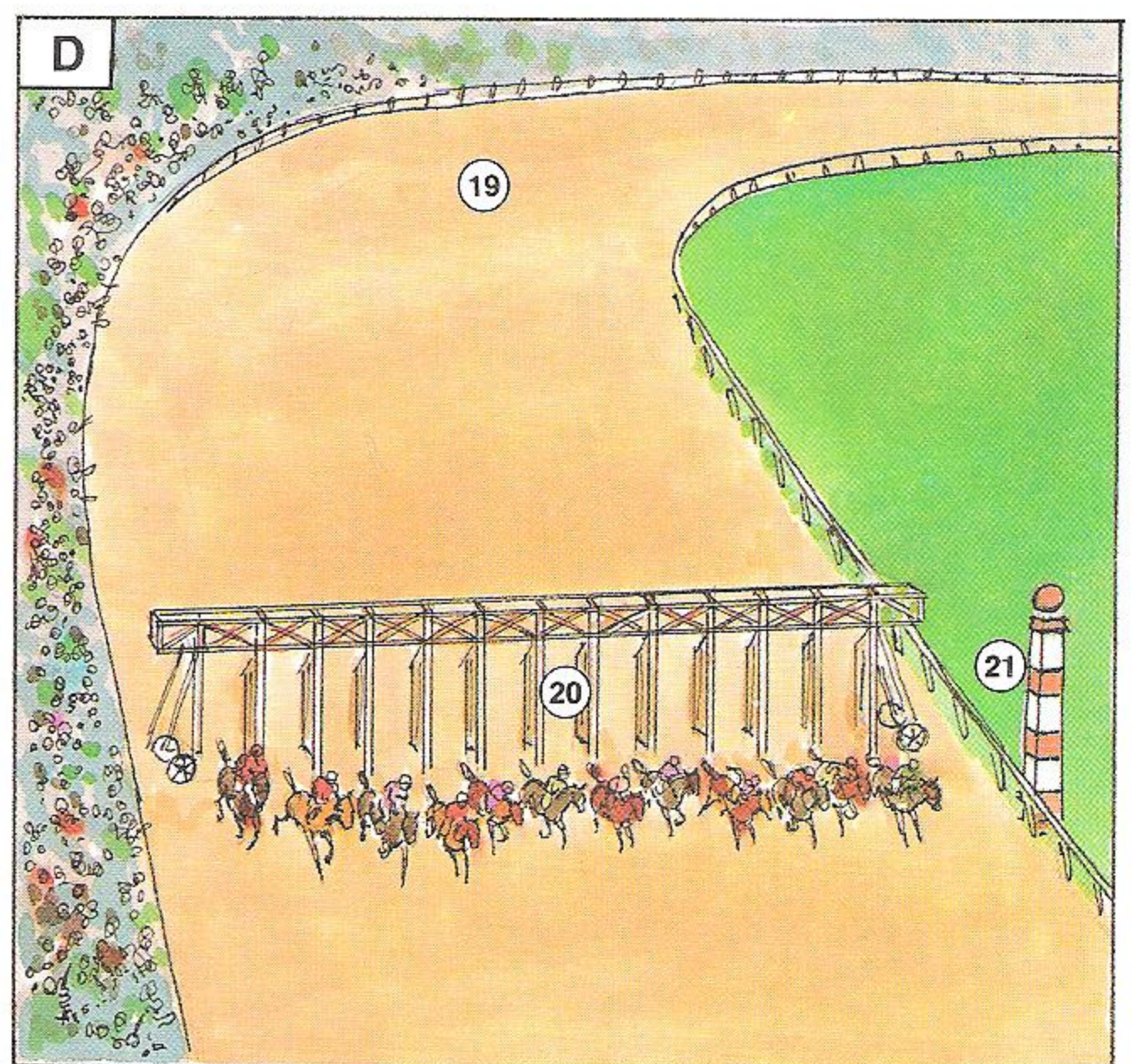
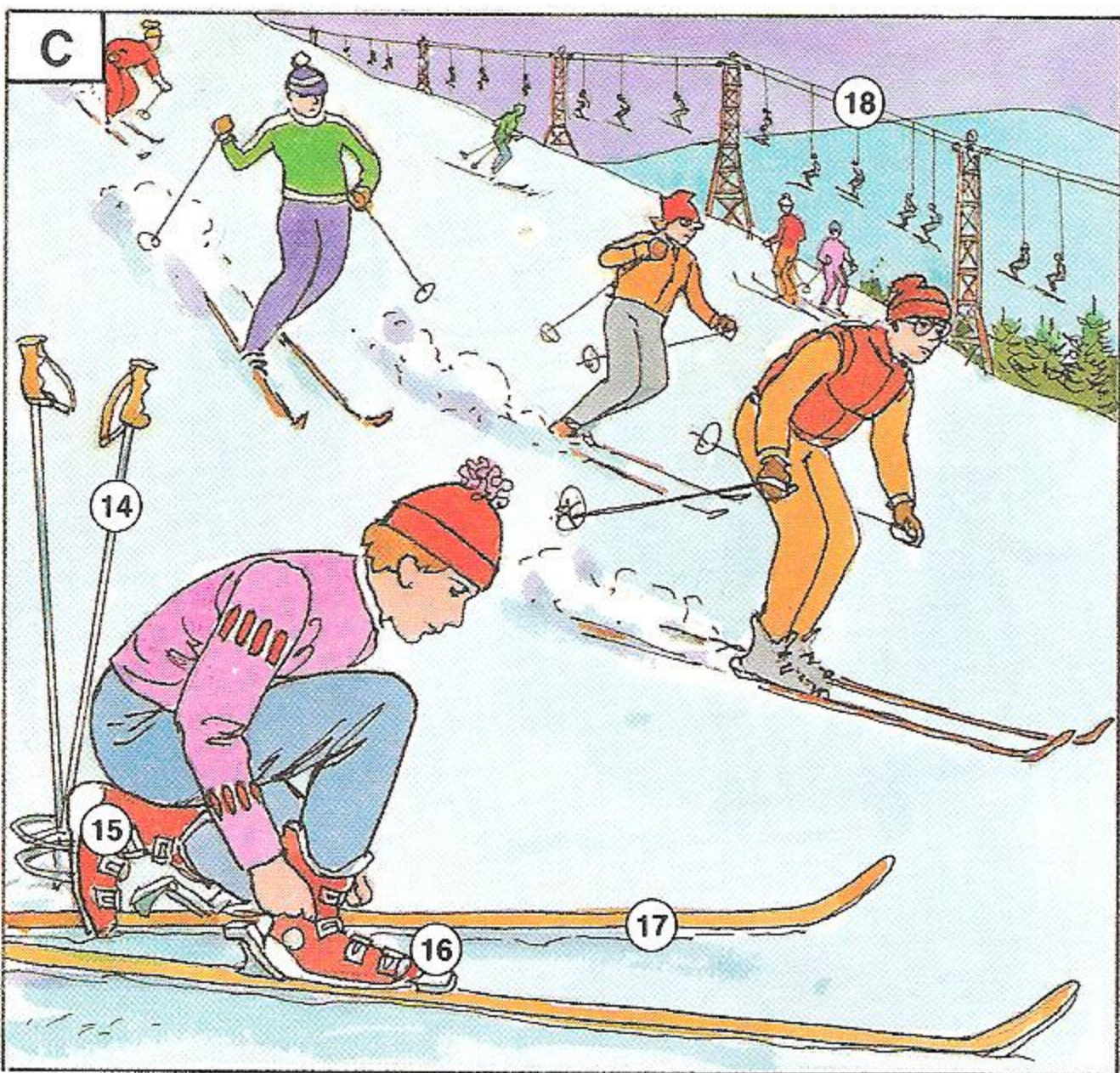
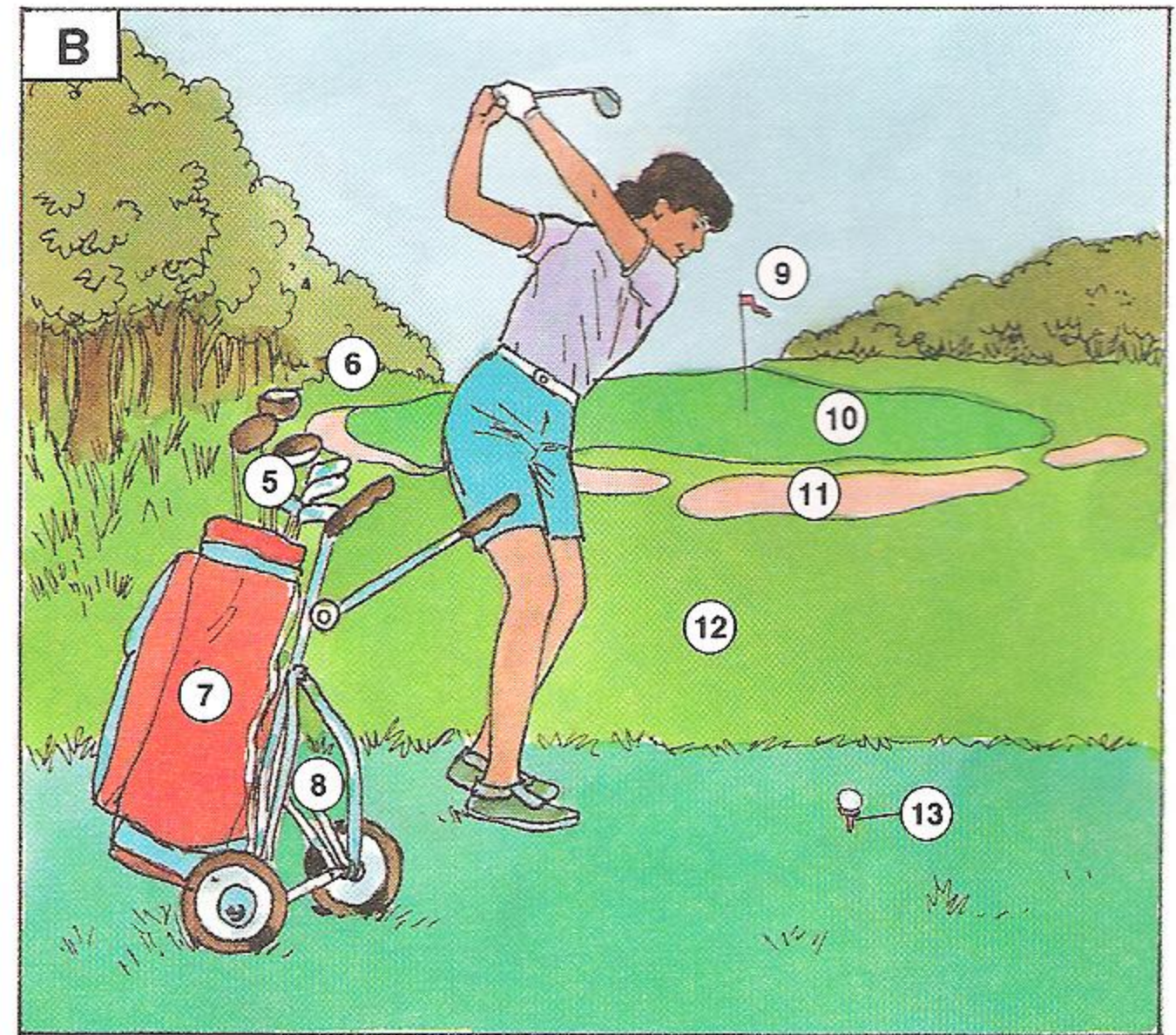
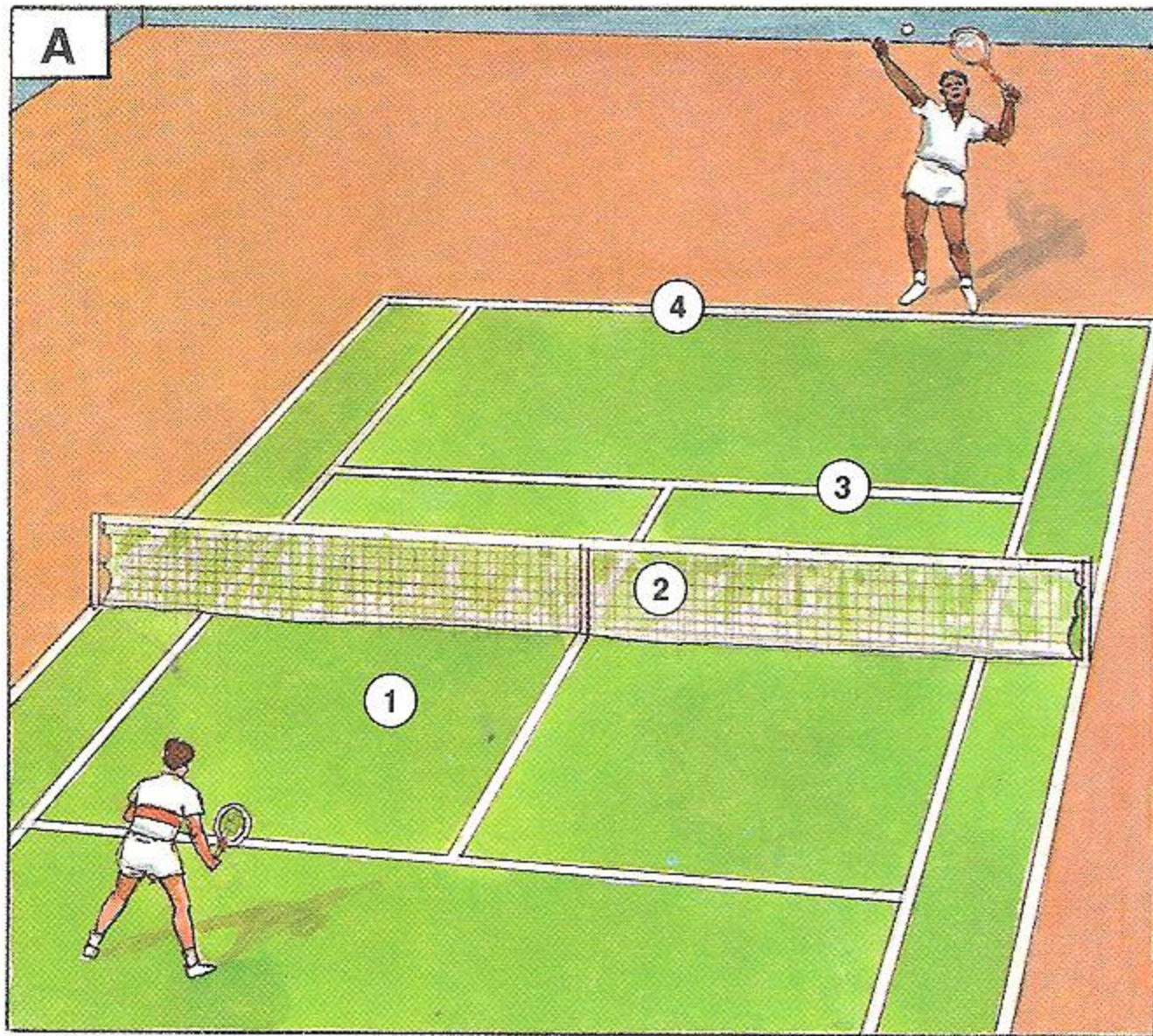

A. Tennis Court

- 1. service court
- 2. net
- 3. service line
- 4. baseline

B. Golf Course

- 5. clubs
- 6. rough
- 7. golf bag

- 8. golf cart

- 9. flag
- 10. green
- 11. sand trap
- 12. fairway
- 13. tee

C. Ski Slope

- 14. pole
- 15. ski boot

- 16. binding

- 17. ski

- 18. ski lift

D. Race Track

- 19. stretch

- 20. starting gate

- 21. finish line

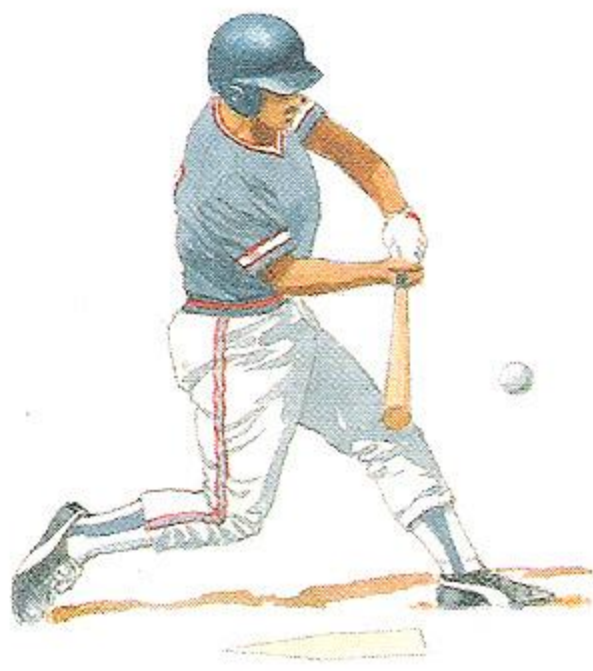

1



2

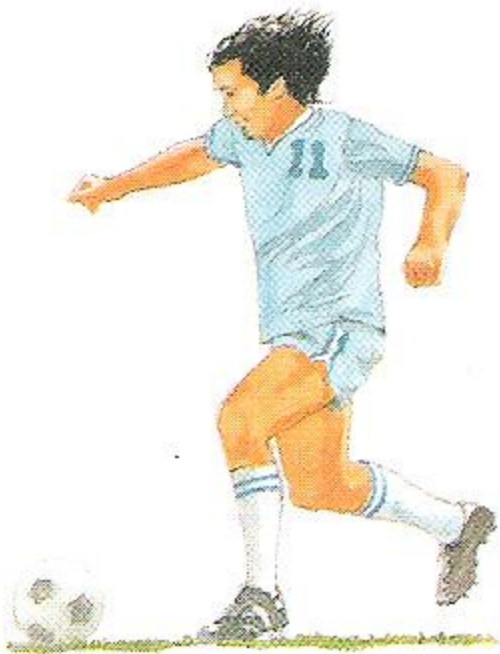

3



4

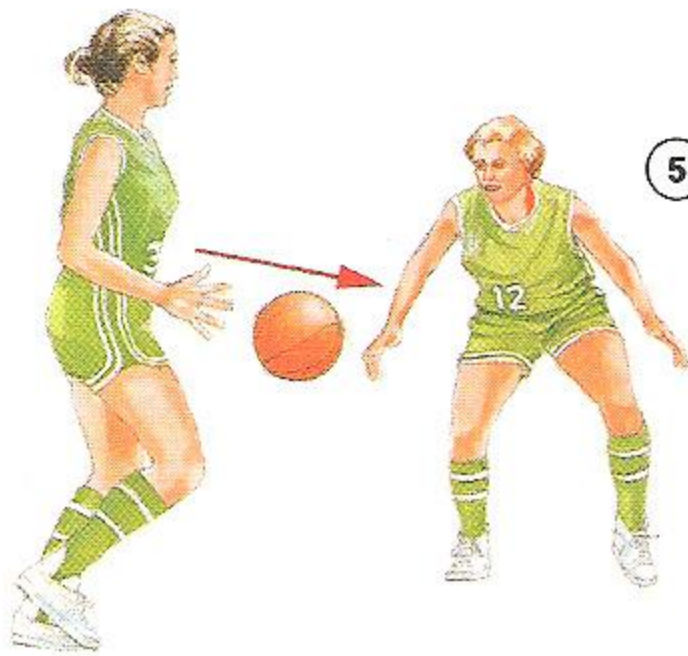

5

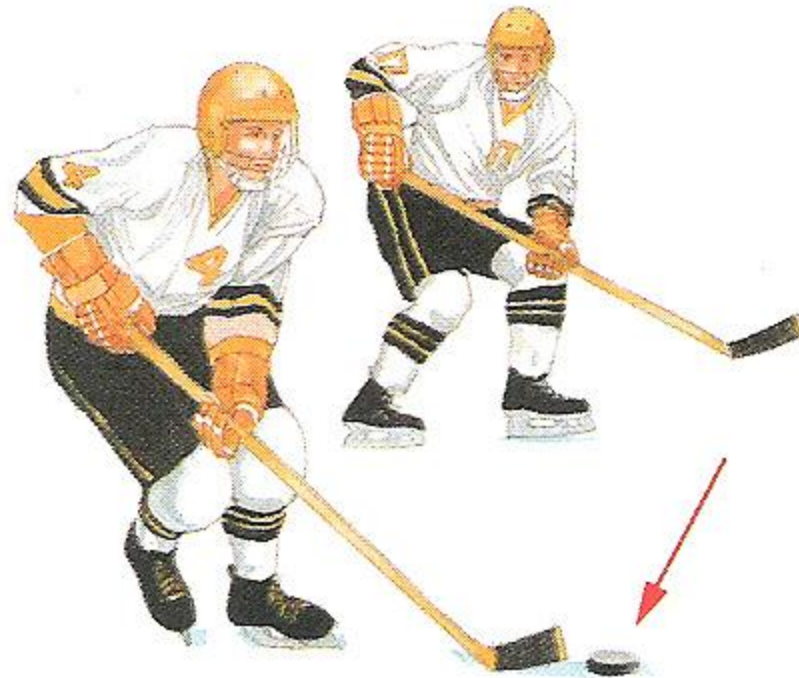

6



7



8



- 1. hit
- 2. serve
- 3. kick

- 4. catch
- 5. pass
- 6. run

- 7. fall
- 8. jump



9

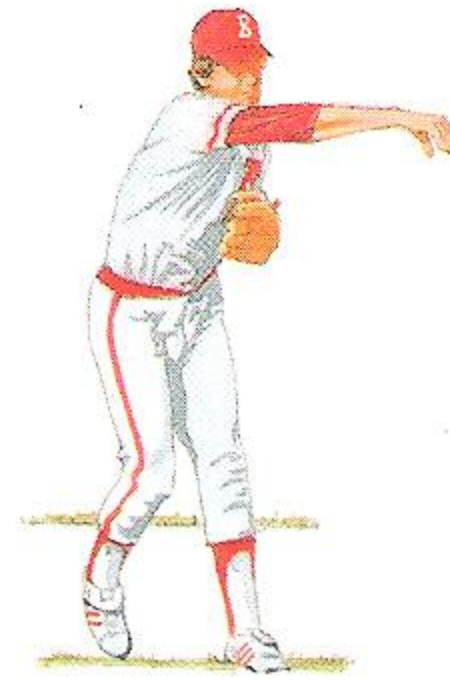

10

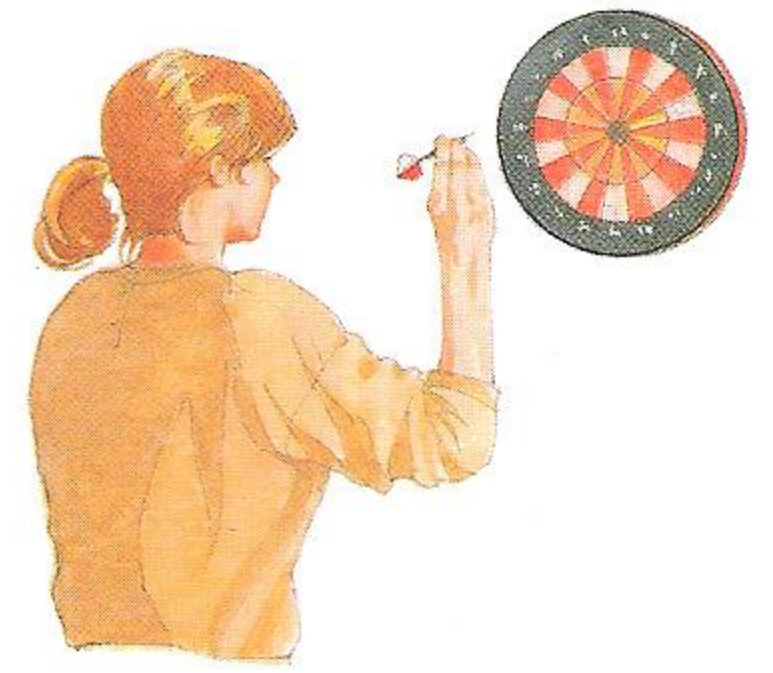

11



12

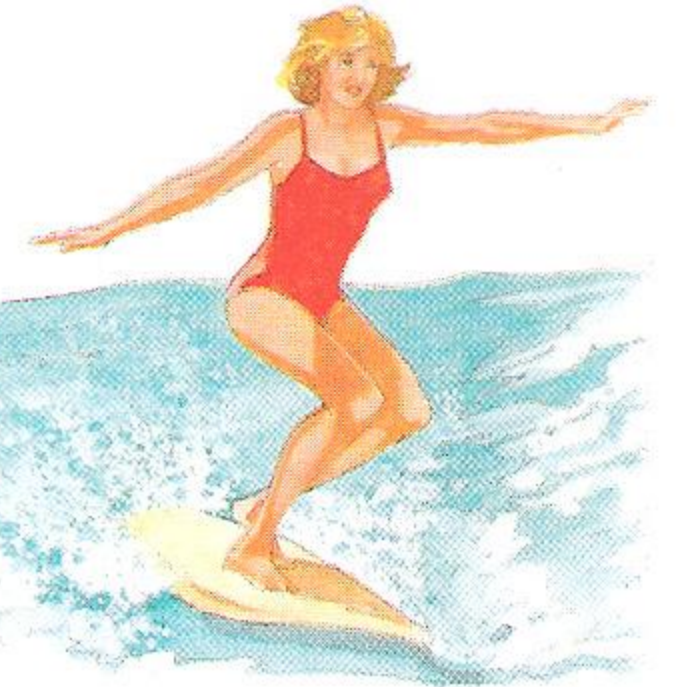

13



14

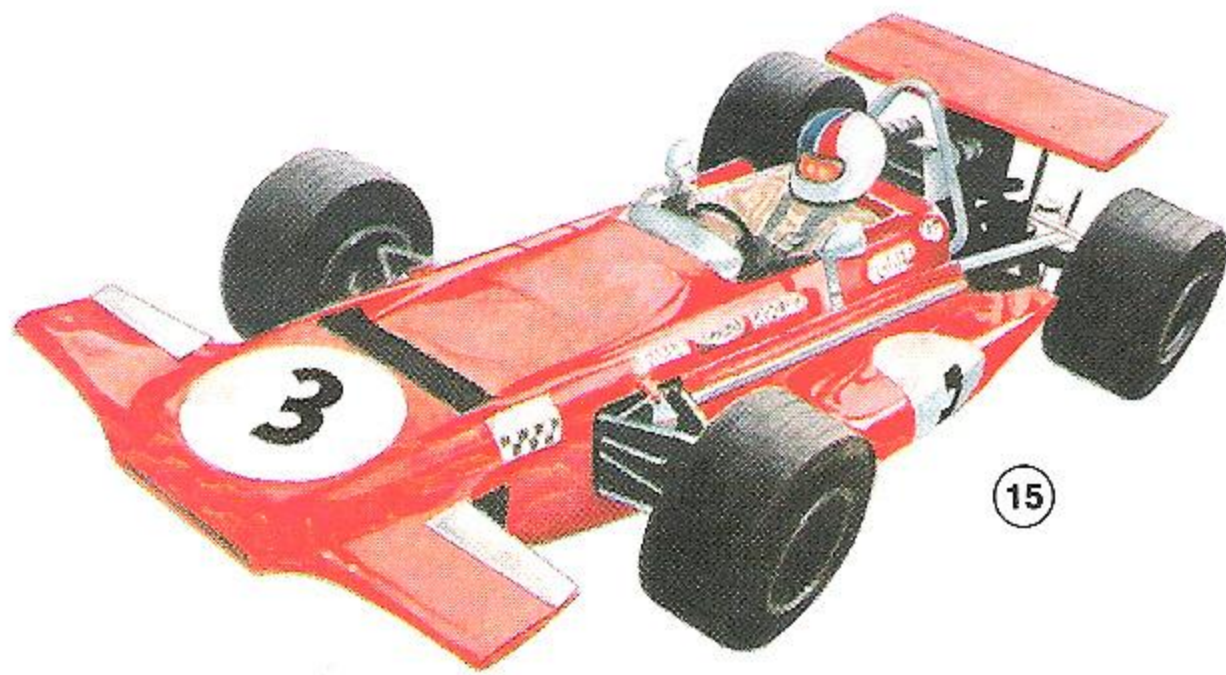
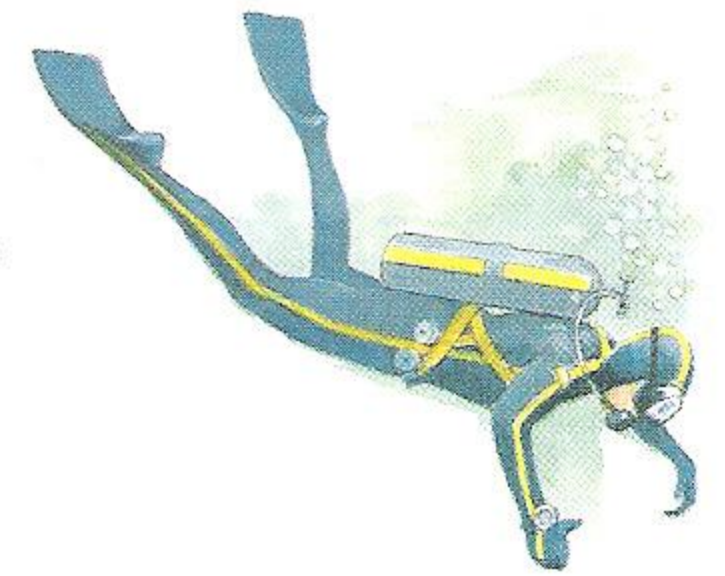

15



16



- 9. skate
- 10. throw
- 11. bounce

- 12. surf
- 13. ride
- 14. dive

- 15. drive
- 16. shoot



Strings

- 1. piano
- a. keyboard
- 2. sheet music
- 3. ukulele
- 4. mandolin
- 5. banjo
- 6. harp
- 7. violin
- a. bow
- 8. viola
- 9. cello
- 10. bass
- a. string

- 11. guitar
- a. pick

Woodwinds

- 12. piccolo
- 13. flute
- 14. bassoon
- 15. oboe
- 16. clarinet

Percussion

- 17. tambourine
- 18. cymbals
- 19. drum
- a. drumsticks
- 20. conga

- 21. kettledrum
- 22. bongos

Brass

- 23. trombone
- 24. saxophone
- 25. trumpet
- 26. French horn
- 27. tuba

Other Instruments

- 28. accordion
- 29. organ
- 30. harmonica
- 31. xylophone

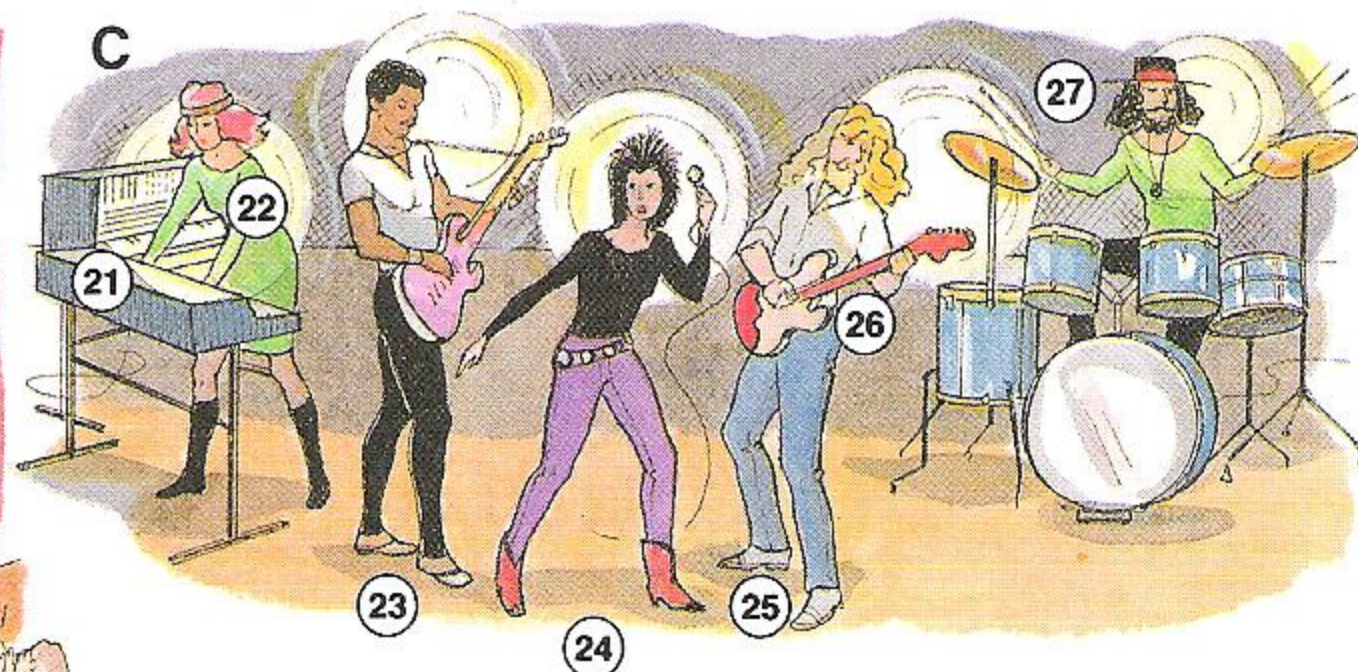
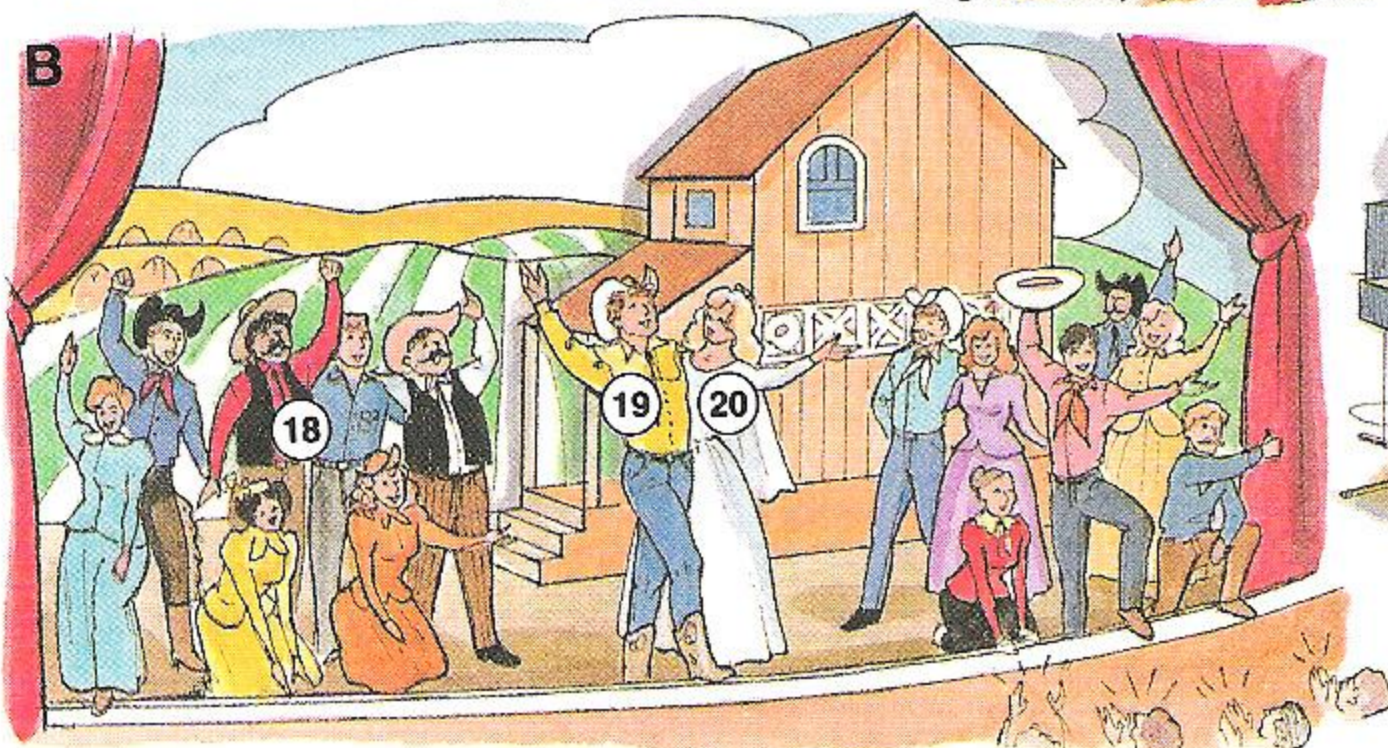
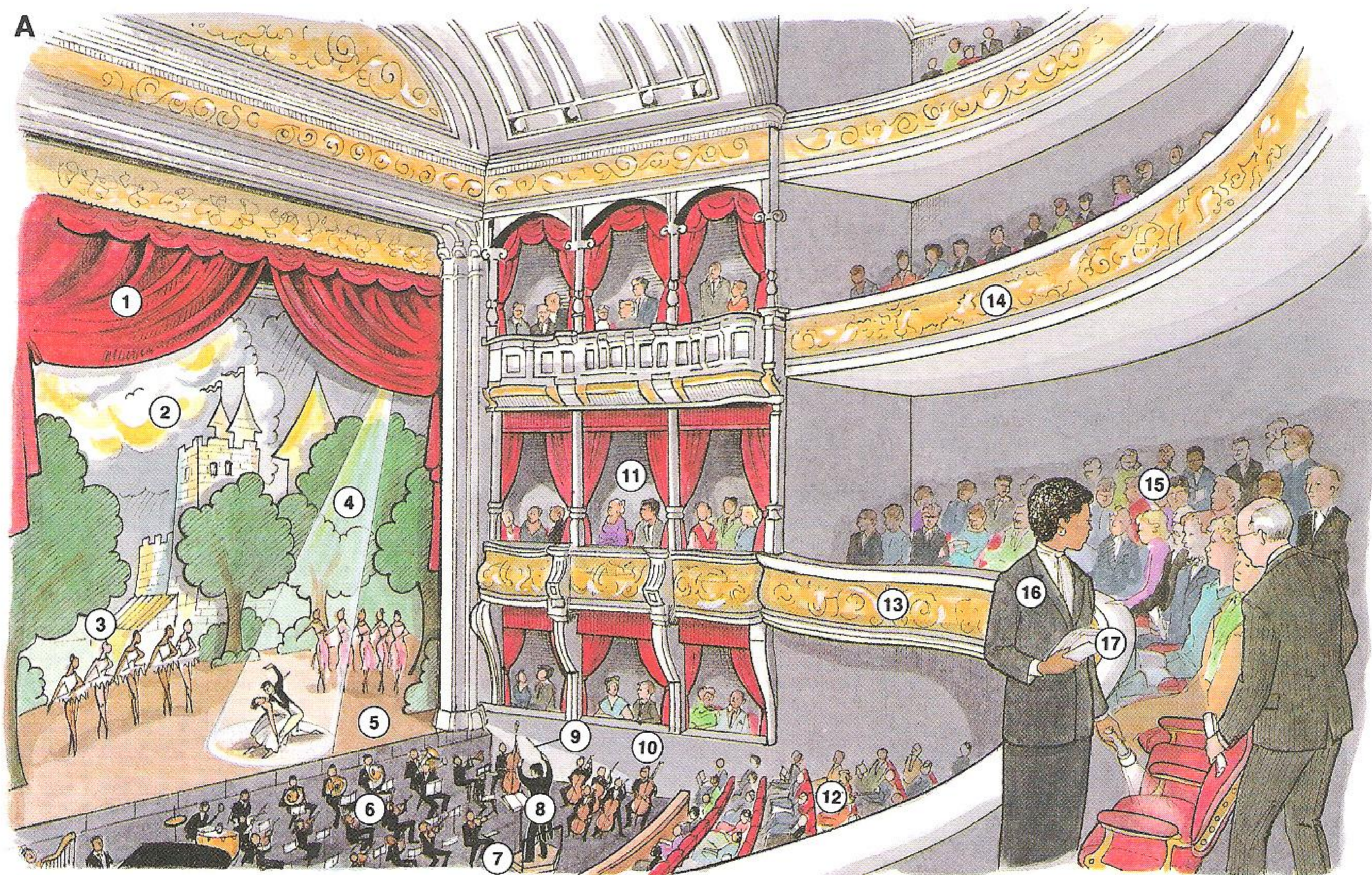

- A. The Ballet**
1. curtain
 2. scenery
 3. dancer
 4. spotlight
 5. stage
 6. orchestra
 7. podium
 8. conductor
 9. baton
 10. musician

11. box seat
 12. orchestra seating
 13. mezzanine
 14. balcony
 15. audience
 16. usher
 17. programs
- B. Musical Comedy**
18. chorus
 19. actor
 20. actress

- C. Rock Group**
21. synthesizer
 22. keyboard player
 23. bass guitarist
 24. singer
 25. lead guitarist
 26. electric guitar
 27. drummer

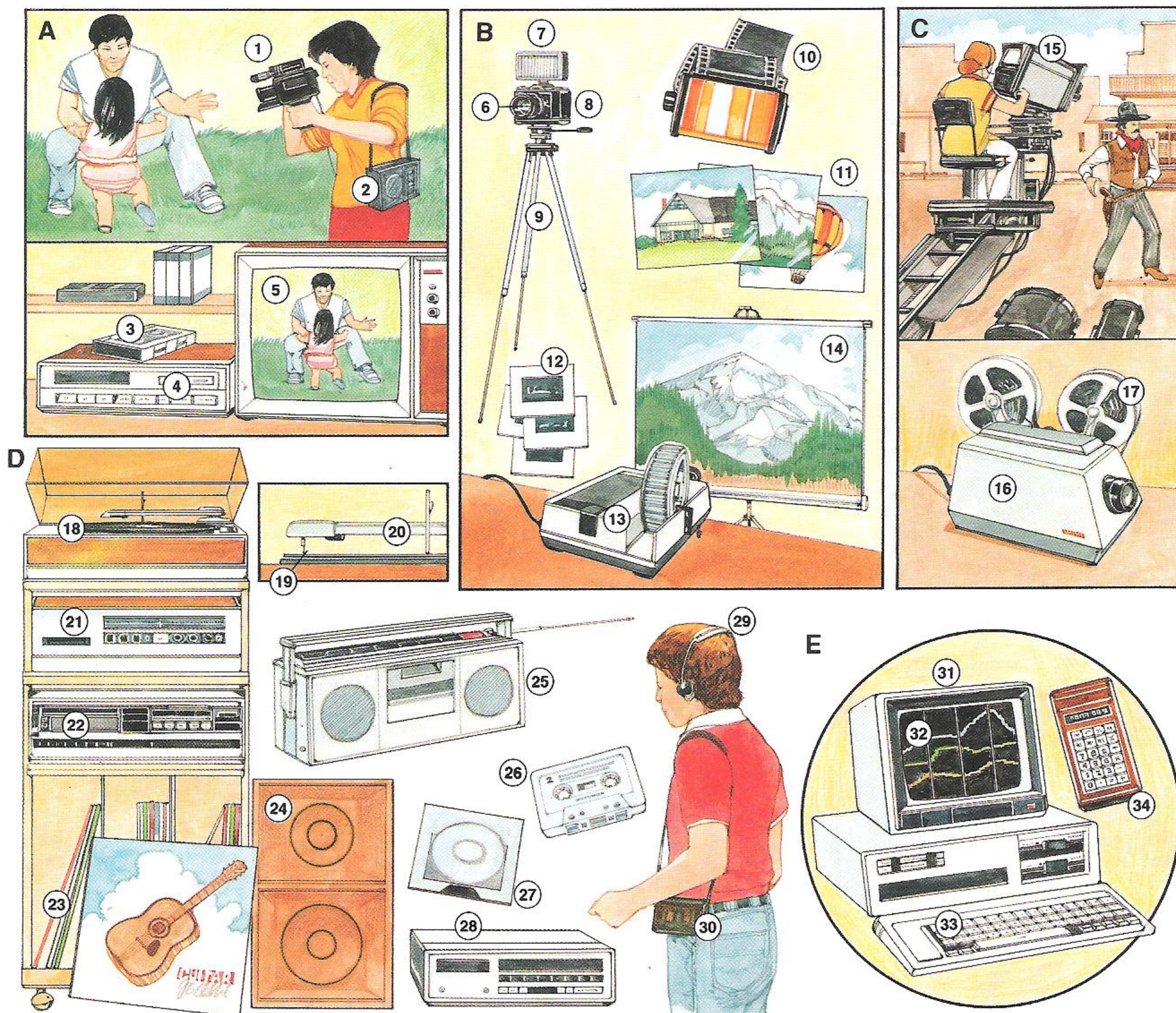

A. Video

- 1. video camera
- 2. Minicam™
- 3. videocassette (tape)
- 4. VCR (videocassette recorder)
- 5. television

B. Photography

- 6. lens
- 7. flash
- 8. camera
- 9. tripod
- 10. (roll of) film
- 11. prints

- 12. slides

- 13. slide projector
- 14. screen

C. Film

- 15. movie camera
- 16. projector
- 17. (reel of) film

D. Audio

- 18. turntable
- 19. cartridge needle
- 20. arm
- 21. receiver
- 22. cassette deck

- 23. records

- 24. speaker
- 25. stereo cassette player
- 26. cassette
- 27. compact disc (CD)
- 28. compact disc player
- 29. headphones
- 30. Sony Walkman

E. Computers

- 31. personal computer (PC)
- 32. monitor
- 33. keyboard
- 34. calculator



A. Sewing

- 1. sewing machine
- 2. (spool of) thread
- 3. pincushion
- 4. material
- 5. pinking shears
- 6. pattern piece
- 7. pattern
- 8. buttonhole
- 9. button
- 10. seam

- 11. hem
- 12. hem binding
- 13. snap
- 14. hook and eye
- 15. tape measure
- 16. zipper
- 17. (pair of) scissors
- 18. needle
- 19. stitch
- 20. pin
- 21. thimble

B. Other Needlecrafts

- 22. knitting
- 23. wool
- 24. skein
- 25. knitting needle
- 26. needlepoint
- 27. embroidery
- 28. crochet
- 29. crochet hook
- 30. weaving
- 31. yarn
- 32. quilting



- | | | |
|--------------------------|--------------------------------|---------------------------|
| 1. at (the window) | 5. on (the rug) | 9. behind (the chair) |
| 2. above (the black cat) | 6. in front of (the fireplace) | 10. on top of (the table) |
| 3. below (the white cat) | 7. in (the drawer) | 11. next to (the TV) |
| 4. between (the pillows) | 8. under (the desk) | |

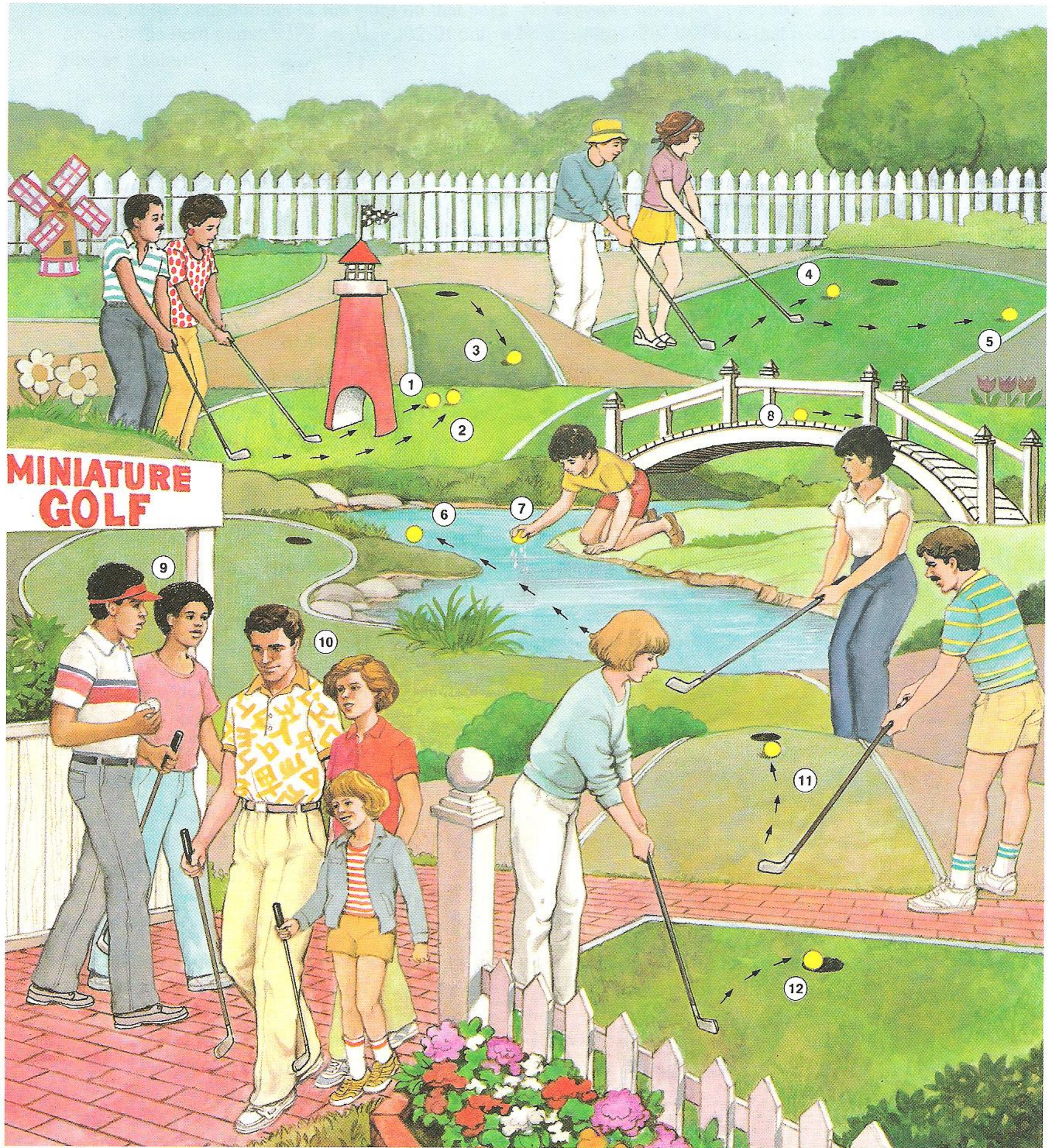

1. through (the lighthouse)
2. around (the lighthouse)
3. down (the hill)
4. toward (the hole)

5. away from (the hole)
6. across (the water)
7. out of (the water)
8. over (the bridge)

9. to (the course)
10. from (the course)
11. up (the hill)
12. into (the hole)

Days of the Week

Sunday
 Monday
 Tuesday
 Wednesday
 Thursday
 Friday
 Saturday

Months of the Year

January
 February
 March
 April
 May
 June
 July
 August
 September
 October
 November
 December

Numbers

0 zero
 1 one
 2 two
 3 three
 4 four
 5 five
 6 six
 7 seven
 8 eight
 9 nine
 10 ten
 11 eleven
 12 twelve
 13 thirteen
 14 fourteen
 15 fifteen
 16 sixteen
 17 seventeen
 18 eighteen
 19 nineteen
 20 twenty
 21 twenty-one
 30 thirty
 40 forty
 50 fifty
 60 sixty
 70 seventy
 80 eighty
 90 ninety
 100 a/one hundred
 500 five hundred
 621 six hundred (and) twenty-one
 1,000 a/one thousand
 1,000,000 a/one million

Colors

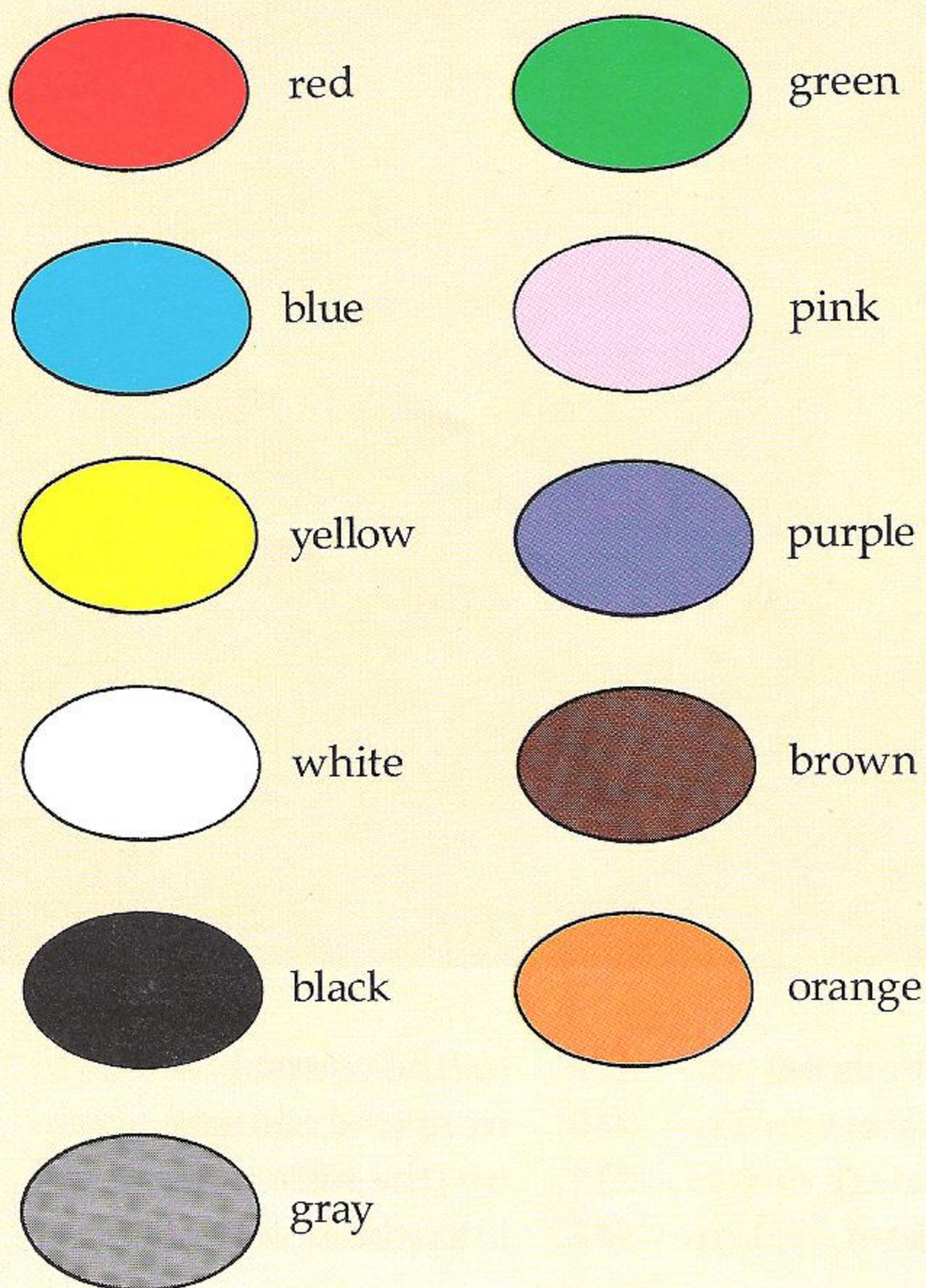

Two numbers occur after words in the index: the first refers to the page where the word is illustrated and the second to the item number of the word on that page. For example, above [ə bŭv/] 102 2 means that the word *above* is the item numbered 2 on page 102. If only a bold number appears, then that word is part of the unit title or a subtitle.

The index includes a pronunciation guide for all the words illustrated in the book. This guide uses symbols commonly found in dictionaries for native speakers. These symbols, unlike those used in transcription systems such as the International Phonetic Alphabet, tend to preserve spelling and so should help you to become more aware of the connections between written English and spoken English.

Consonants

[b] as in back [băk]	[k] as in kite [kīt]	[sh] as in shell [shēl]
[ch] as in cheek [chēk]	[l] as in leaf [lēf]	[t] as in tape [tāp]
[d] as in date [dāt]	[m] as in man [măn]	[th] as in three [thrē]
[dh] as in the [dh]	[n] as in neck [nēk]	[v] as in vine [vīn]
[f] as in face [fās]	[ng] as in ring [rīng]	[w] as in waist [wāst]
[g] as in gas [gās]	[p] as in pack [păk]	[y] as in yam [yām]
[h] as in half [hăf]	[r] as in rake [rāk]	[z] as in zoo [zōō]
[j] as in jack [jăk]	[s] as in sand [sănd]	[zh] as in measure [mēzh/ər]

Vowels

[ā] as in bake [bāk]	[ī] as in lime [līm]	[ōō] as in cool [kōōl]
[ă] as in back [băk]	[ĭ] as in lip [lĭp]	[ōō] as in book [bōōk]
[ā] as in bar [bār]	[ī] as in beer [bīr]	[ow] as in cow [kow]
[ē] as in beat [bēt]	[ō] as in post [pōst]	[oy] as in boy [boy]
[ē] as in bed [bēd]	[ō] as in box [bōks]	[ū] as in cut [kūt]
[ĕ] as in bear [bēr]	[ö] as in claw [klö] or for [för]	[ü] as in curb [kürb]
		[ə] as in above [ə bŭv/]

All pronunciation symbols used are alphabetical except for the schwa [ə], which is the most frequent vowel sound in English. If you use it appropriately in unstressed syllables, your pronunciation will sound more natural.

You should note that an umlaut (¨) calls attention to the special quality of vowels before [r]. (The sound [ö] can also represent a vowel not followed by [r] as in *claw*.) You should listen carefully to native speakers to discover how these vowels actually sound.

Stress

This guide also follows the system for marking stress used in many dictionaries for native speakers.

- (1) Stress is not marked if a word consisting of a single syllable occurs in isolation.
- (2) Where stress is marked, two levels are distinguished:
 - a bold accent [/] is placed after each syllable with primary stress,
 - a light accent [/] is placed after each syllable with secondary stress.

Syllable Boundaries

Syllable boundaries are indicated by a single space.

NOTE: The pronunciation used in this index is based on patterns of American English. There has been no attempt to represent all of the varieties of American English. Students should listen to native speakers to hear how the language actually sounds in a particular region.

- above [ə bʊv/] 102 2
 abdomen [ˈæb/də mən] 4 14
 accelerator [ˈæk səl/ə rā/tər] 50 27
 accordion [ə kɔr/dē ən] 98 28
 accountant [ə kəʊn/tənt] 86 18
 acorn [ə kɔrn] 61 33b
 acorn squash [ˈæ kɔrn skwɔʃh/] 7 28
 across [ə krɔs/] 103 6
 actor [ˈæ k/tər] 99 19
 actress [ˈæ k/trəs] 99 20
 acute angle [ə kyoot/ˈæŋg/gəl] 79 8
 address [ˈæ drəs] 46 11
 adjectives [ˈæ j/ɪk tɪvz] 24, 25
 aerial tramway [ˈer/ē əl trəm/wā] 55 31
 Africa [ˈæ frɪ kə] 70 4
 after-shave lotion [ˈæ f/tər shāv lō/shən] 23 21
 ailments [ˈæl mənts] 40
 air conditioner [ˈer/kən dī/shə nər] 32 11
 air filter [ˈer/fɪl/tər] 51 52
 Air Force [ˈer/fɔrs/] 48 19
 air mattress [ˈer/mā trəs] 91 26
 air pump [ˈer/pʌmp/] 53 13
 air travel [ˈer/trā vəl] 56
 aircraft [ˈer/kræft/] 57
 aircraft carrier [ˈer/kræft kār/yər] 48 4
 aircraft types [ˈer/kræft tɪps/] 57
 (airmail) envelope [ˈer/māl ɛn/və lɔp] 46 16
 airman [ˈer/mən] 48 20
 airport check-in [ˈer/pɔrt chɛk/ɪn] 56
 aisle [ɪ/əl] 14 10, 56 23
 Alabama [ˈæl/ə bā/mə] 72 1
 alarm clock [ə lārm/klɔk] 32 8
 Alaska [ə lās/kə] 72 2
 alcohol [ˈæl/kə hɔl/] 39 22
 alligator [ˈæl/ə gā/tər] 65 8
 almond(s) [ɔ/ˈmænd(z)] 9 31
 Alps [ˈæ lps] 70 44
 Amazon River [ˈæ/mə zɔn rɪv/ər] 71 59
 ambulance [ˈæm/byə ləns] 42 6
 amphibians [ˈæm fɪ/bē ənz] 65
 ammunition [ˈæm/yə nɪʃ/ən] 48
 anchor [ˈæŋg/kər] 58 24
 Andes [ˈæn/dēz] 71 43
 ankle [ˈæŋg/kəl] 5 49
 animals [ˈæn/ə mɔlz] 62-69
 ant [ˈænt] 63 12
 Antarctic Ocean [ˈænt ər k/ tɪk ɔ/ shən] 70 14
 Antarctica [ˈænt ər k/tɪ kə] 70 7
 anteater [ˈænt/ē/tər] 66 5
 antenna [ˈæn tən/ə] 51 46, 62 1b
 antler [ˈænt/lər] 67 35a
 apartment house [ə pärt/mənt hɔws/] 45 23
 apex [ˈæ pɛks] 79 21
 Appalachian Mountains [ˈæp/ə lā/che ən məʊn/ tənz] 71 41
 apple [ˈæ pəl] 8 2
 apricot [ˈæp/rə kɔt/] 9 25
 apron [ˈæ prən] 16 6
 aquatic mammals [ə kwɔ/ tɪk mǎ/ mɔlz] 68
 Arabian Sea [ə rā/bē ən sē/] 70 30
 arc [ˈærk] 79 16
 architect [ˈær/kə tɛkt/] 86 8
 Arctic [ˈærk/ tɪk] 70 8
 Arizona [ˈær/ə zō/nə] 72 3
 Arkansas [ˈær/kən sō/] 72 4
 arm [ˈärm] 4 6, 100 20
 armadillo [ˈær/mə dɪl/ɔ] 66 2
 armed forces [ˈärmd/ fɔr/səz] 48
 armpit [ˈärm/pɪt/] 4 10
 armrest [ˈärm/rɛst/] 50 3
 Army [ˈær/mē] 48 15
 around [ə rownd/] 103 2
 artery [ˈær/tə rē] 5 69
 artichoke [ˈær/tə chɔk/] 6 11
 artist [ˈær/təst] 86 3
 arts [ˈärts] 86
 ashtray [ˈæʃ/trā/] 16 29
 Asia [ˈā zhə] 70 5
 asparagus [ə spār/ə gəs] 6 18
 asteroid [ˈäs/tə royd/] 74 20
 astronaut [ˈäs/trə nɔt/] 75 5
 at [ət] 102 1
 Atacama Desert [ˈät/ə kɔ/ mə dɛz/ ert] 71 50
 athletic supporter [ˈäth lɛ/ tɪk sə pɔr/tər] 22 4
 atlas [ˈät/ləs] 47 20
 attachments [ə täch/mənts] 35 17
 attendant [ə tɛn/dənt] 39 8, 53 12
 audience [ˈö/dē əns] 99 15
 audio [ˈö/dē ɔ/] 100
 aunt [ˈänt] 3 6
 Australia [ˈö strāl/yə] 70 6
 author [ˈö/thər] 47 8
 automatic transmission [ˈö/ tə mät/ɪk trənz mɪ/shən] 50
 avocado [ˈäv/ə kɔ/dō] 9 33
 away from [ə wā/ frəm] 103 5
 axe [ˈæks] 42 14
 baboon [ˈbā bōon/] 69 19
 baby [ˈbā/bē] 2 5
 baby carriage [ˈbā/bē kār/ɪj] 45 27
 baby lotion [ˈbā/bē lō/shən] 33 6
 baby powder [ˈbā/bē pow/dər] 33 7
 baby wipes [ˈbā/bē wɪps/] 33 8
 baby's room [ˈbā/bēz room/] 33
 back [ˈbæk] 4 11, 23 19
 backache [ˈbæk/āk/] 40 8
 backboard [ˈbæk/bɔrd/] 92 19
 backhoe [ˈbæk/hō/] 82 26
 backpack [ˈbæk/pæk/] 19 4
 backseat [ˈbæk/sēt/] 50 32
 backyard [ˈbæk/yärd/] 27
 back-up light [ˈbæk/əp lɪt/] 50 30
 bacon [ˈbā/kən] 10 11, 18, 33
 badge [ˈbæj] 43 5
 Baffin Bay [ˈbäf/ən bā/] 70 16
 bag [ˈbæg] 12 8, 15 25, 21 35
 baggage [ˈbæg/ɪj] 56 8
 bake [ˈbæk] 31 14
 baked beans [ˈbäkt/bēnz/] 18 3
 baked goods [ˈbäkt gōodz/] 14 11
 baked potato [ˈbäkt/pə tā/tō] 18 20
 baker [ˈbā/kər] 84 8
 bakery [ˈbā/kə rē] 44 6
 balance beam [ˈbäl/əns bēm/] 94 24
 balcony [ˈbäl/kə nē] 99 14
 (bale of) hay [ˈbāl/əv hā/] 81 13
 ball [ˈbɔl] 5 52
 ballet [ˈbäl/ä/] 99
 ballfields [ˈbɔl/fēldz/] 93
 ballpoint pen [ˈbɔl/pɔɪnt pɛn/] 76 22
 Baltic Sea [ˈbɔl/tɪk sē/] 70 22
 bananas [ˈbɔ nā/nəz] 9 20
 Band-Aid [ˈbänd/äd/] 39 4
 band shell [ˈbänd/shɛl/] 87 2
 bandage [ˈbänd/dɪj] 39 24

- banister [bän'ə stər] 28 11
 banjo [bän'jō'] 98 5
 banking [bäng'kīng] 86
 bar [bär] 13 18, 16 24
 bar stool [bär'stōol'] 16 25
 barber [bär'bər] 84 3
 Barents Sea [bär'ənts sē'] 70 23
 barge [bärj] 58 12
 bark [bärk] 61 35c
 barn [bärn] 81 5
 barnyard [bärn'yärd'] 81 8
 barrel [bär'əl] 48 23
 barricade [bär'ə käd'] 82 21
 bartender [bär'ten'dər] 16 21
 base [bäs] 79 7, 93 6
 baseball [bäs'böl'] 92
 baseball diamond [bäs'böl dī'mənd]
 93
 baseline [bäs'līn'] 95 4
 basin [bäsən] 39 16
 basket [bäs'kæt] 92 20
 basketball [bäs'kæt bōl'] 92, 92 21
 bass [bäs] 98 10
 bass guitarist [bäs'gə tär'əst] 99 23
 bassoon [bäsōon'] 98 14
 bat [bät] 66 4, 92 5
 batboy [bät'boy'] 93 18
 bath mat [bäth'mät'] 34 12
 bath towel [bäth'tow'əl] 34 24
 bathing suit [bä'dhīng sōot'] 90 18
 bathing trunks [bä'dhīng trūngks']
 91 33
 bathrobe [bäth'rōb] 22 20
 bathroom [bäth'rōom'] 34
 bathtub [bäth'tüb'] 34 11
 baton [bətōn'] 99 9
 batter [bät'ər] 92 7, 93 14
 battery [bät'ərē] 51 54
 batting helmet [bät'īng hēl'mət] 92 6
 battleship [bät'əl shīp'] 48 5
 Bay of Bengal [bä'əv bēn gōl'] 70 32
 bayonet [bä'ə nēt'] 48 24
 bays [bāz] 70
 beach [bēch] 90
 beach ball [bēch'bōl'] 90 11
 beach chair [bēch'chēr'] 90 20
 beach towel [bēch'tow'əl] 90 15
 beach umbrella [bēch'əm brēl'ə]
 90 21
 beads [bēdz] 23 7
 beak [bēk] 64 3a
 beaker [bē'kər] 78 23
 beard [bīrd] 4 39
 bears [bērz] 69
 beat [bēt] 31 8
 Beaufort Sea [bō'fərt sē'] 70 15
 beaver [bē'vər] 66 12
 bed [bēd] 32 21
 bed rest [bēd'rēst'] 41 1
 bedroom [bēd'rōom'] 32
 bedspread [bēd'sprēd'] 32 23
 bee [bē] 63 19
 beef [bēf] 10 1
 beef stew [bēf'stōō'] 18 14
 beer [bīr] 16 23
 beet(s) [bēts] 7 33
 beetle [bē'təl] 63 10
 behind [bə'hīnd'] 102 9
 below [bə'lō'] 102 3
 belt [bēlt] 20 16
 bench [bēnch] 43 16, 44 14, 78 24,
 87 10
 beret [bə'rā'] 19 22
 Bering Sea [bēr'īng sē'] 70 34
 berries [bēr'ēz] 8
 between [bə'twēn'] 102 4
 beverages [bēv'rəjəz] 14 14
 bib [bīb] 33 20
 bicycle [bī'sī kəl] 52 15
 big [bīg] 24 8
 (Big Dipper) constellation
 [bīg'dī'pər kōn stə'lā'shən] 74 3
 big toe [bīg'tō'] 5 53
 bike stand [bīk'stānd'] 52 14
 biker [bī'kər] 90 4
 bikes [bīks] 52
 (bikini) panties [bə'kē'nē pän'tēz]
 22 11
 bill [bīl] 64 24a
 bin [bīn] 15 16
 binding [bīn'dīng] 95 16
 binoculars [bə'nōk'yə'lərs] 90 7
 birch [bīrch] 61 32
 birds [bīrdz] 64
 biscuit [bīs'kət] 18 27
 bison [bī'sən] 67 19
 bit [bīt] 37 43a
 black bear [bläk'bēr'] 69 21
 black bean(s) [bläk'bēn(z)'] 6 14
 black eye [bläk'ī'] 40 5
 Black Sea [bläk'sē'] 70 26
 blackberries [bläk'bēr'ēz] 8 12
 bladder [blä'dər] 5 72
 blade [blād] 94 27
 blanket [bläng'ket] 32 20
 blazer [blä'zer] 20 2
 bleach [blēch] 35 26
 blender [blēn'dər] 30 12
 blimp [blīmp] 57 5
 blinds [blīndz] 32 12
 block [blök] 33 32
 blouse [blows] 21 34
 blue jay [blōō'ja'] 64 8
 (blue) jeans [blōō'jēnz'] 19 6
 blueberries [blōō'bēr'ēz] 8 14
 blueprints [blōō'prīnts'] 82 6
 blush [blūsh] 23 32
 board [bōrd] 82 16
 boarding [bör'dīng] 56
 boarding pass [bör'dīng pās'] 56 18
 boardwalk [bōrd'wōk'] 90 1
 body [bö'dē] 4
 boil [boyl] 31 16
 bollard [böl'ərd] 58 26
 bolt [bōlt] 37 38
 bomb [bōm] 48 3
 bomber [bōm'ər] 48 2
 bongos [böng'gōz] 98 22
 book [böök] 13 17
 (book of) matches [böök'əv mäch'chəz]
 16 28
 bookcase [böök'kās] 28 22, 83 20
 bookstore [böök'stōr] 45 18
 boom [bōom] 59 7
 booth [bōoth] 16 9
 boots [böots] 19 21, 21 32
 bottle [böt'əl] 12 3, 33 17
 bottle opener [böt'əlō'pənər] 30 6
 bounce [bəuns] 97 11
 bow [bō] 98 7a
 bow [bow] 58 5
 bowl [bōl] 13 23
 bowling [bōl'īng] 94

- bowling ball [bōl'ɪŋ bōl/] 94 6
 box [bɒks] 13 12
 box seat [bɒks' sēt/] 99 11
 box spring [bɒks' sprɪŋ/] 32 18
 boxer shorts [bɒk' sər shɔrts/] 22 2
 boxing [bɒk' sɪŋ] 94
 boy's frame [boɪz' frām/] 52 11
 bra(ssiere) [brəʊ]/[brə zɪr/] 22 13
 brace [bræs] 36 9
 bracelet [bræs' lət] 23 9
 brain [brān] 5 57
 brake [brāk] 50 26, 52 17
 brake light [brāk' lɪt/] 50 29
 branch [brānch] 61 35a
 brass [bræs] 98
 bread [brəd] 14 12
 bread and butter plate
 [brəd' ənd bʊt' ər plāt/] 29 11
 break [brāk] 31 7
 breast [brɛst] 11 21
 bricks [brɪks] 82 12
 bridle path [brɪd' əl pæθ/] 87 7
 briefcase [brɛf' kæs/] 21 37
 briefs [brɛfs] 22 12
 broccoli [brɒk' ə lɛ] 6 2
 broil [broɪl] 31 13
 broiler [broɪl' ə] 30 33
 broken bone [brɒ' kən bɒn/] 40 15
 broom [brōm] 35 7
 brother [brʊdh' ə] 3 9
 brother-in-law [brʊdh' ə ɪn lɔ/] 3 11
 bruise [brūz] 40 17
 brush [brʊʃ] 76 18
 brussels sprouts [brʊs' əl sprəʊts/] 6 4
 bucket [bʊk' ət] 35 15
 bucket seat [bʊk' ət sēt/] 50 16
 buckle [bʊk' əl] 20 17
 bud [bʊd] 60 18a
 buffet [bʊ fæ/] 29 29
 builder [bɪl' dɔr] 82 5
 building number [bɪl' dɪŋ nʊm' bɔr]
 45 24
 bulb [bʊlb] 60 8a
 bull [bʊl] 67 34
 bulldozer [bʊl' dɔzər] 82 27
 bullet [bʊl' ɪt] 48 26
 bulletin board [bʊl' ɪ tən bɔrd/] 76 7
 bumper [bʊm' pɔr] 33 5
 bun [bʊn] 18 7
 bunch [bʊnch] 8 1
 Bunsen burner [bʊn' sən bʊr' nɔr]
 78 20
 buoy [bʊ' ē]/[boɪ] 58 16
 bureau [byʊr' ə] 32 9
 burn [bʊrn] 17 14, 40 18
 burner [bʊr' nɔr] 30 29
 bus [bʊs] 53 20, 54
 bus driver [bʊs' drɪ' vɔr] 54 3
 bus stop [bʊs' stɒp/] 44 13
 busboy [bʊs' boɪ/] 16 3
 bushes [bʊʃ' əz] 61 41
 business workers [bɪz' nəs wʊr' kɔrz] 86
 butcher [bʊt' chɔr] 84 13
 butter [bʊt' ə] 18 18
 buttercup [bʊt' ə kʊp/] 60 17
 butterfly [bʊt' ə flɪ/] 63 3
 buttocks [bʊt' əks] 4 15
 button [bʊt' ən] 20 3, 101 9
 buttonhole [bʊt' ən hɔl/] 101 8
 C-clamp [sɛ' klæmp/] 36 2
 cab driver [kæb' drɪ' vɔr] 55 26
 cabbage [kæb' ɪj] 6 3
 cabin [kæb' ɪn] 56 19
 cabin cruiser [kæb' ɪn krʊ' zɔr] 59 16
 cabinet [kæb' ə nət] 30 22
 cable [kæ' bəl] 52 23
 cable car [kæ' bəl kær/] 55 32
 cactus [kæk' təs] 61 40
 calculator [kæl' kyə lā' tɔr] 83 19,
 100 34
 calendar [kæl' ən dɔr] 83 9
 calf [kæf] 4 20, 67 31
 California [kæl' ə fɔr' nyə] 72 5
 call card [kɔl' kɑrd/] 47 6
 call number [kɔl' nʊm' bɔr] 47 6
 call slip [kɔl' slɪp/] 47 12
 camel [kæm' əl] 67 33
 camera [kæm' ə] 100 8
 cameraperson [kæm' ə ɔ pɪr' sən] 86 10
 camisole [kæm' ə sɔl/] 22 9
 camp stove [kæmp' stɒv/] 89 25
 camper [kæm' pɔr] 53 16
 campfire [kæmp' fɪr/] 89 31
 camping [kæm' pɪŋ] 89
 can [kæn] 12 10
 can opener [kæn' ə' pə nɔr] 30 4
 canary [kə nɛr' ē] 64 14
 candle [kænd' əl] 29 27
 candlestick [kænd' əl stɪk/] 29 28
 canister [kæn' ə stɔr] 30 15
 canned goods [kænd' gʊdz/] 14 13
 cannon [kæn' ən] 48 11
 canoe [kə nɔ' ə] 59 2
 cantaloupe [kæn' təl ɒp/] 9 36
 canyon [kæn' yən] 88 3
 cap [kæp] 19 2, 21 43, 92 11
 capsule [kæp' səl] 41 5
 car [kær] 54 9
 card catalog [kɑrd' kæt' ə lɔg] 47 4
 cardigan [kær' dɪ gən] 21 26
 cardinal [kɑrd' nəl] 64 11
 cargo [kær' gɔ] 58 10
 cargo area [kær' gɔ ɛr' ē ə] 57 12
 cargo bay [kær' gɔ bā/] 75 9
 cargo door [kær' gɔ dɔr/] 57 13
 Caribbean Sea [kær' ə bɛ' ən sɛ']
 70 20
 carpenter [kær' pən tɔr] 85 2
 carpenter's rule [kær' pən tɔr rʊl']
 36 1
 carrot(s) [kær' ət(s)] 7 32
 carry [kær' ē] 26 16
 carry-on bag [kær' ē ɒn bæɡ/] 56 2
 cars [kærz] 50-51
 carton [kær' tən] 12 1
 cartridge needle [kær' trɪj nɛ' dəl]
 100 19
 carve [kærv] 31 6
 cash register [kæʃ' rɛ' jə stɔr] 15 21
 cashew(s) [kæʃ' əʊ(z)] 9 27
 cashier [kæʃɪr] 15 22
 Caspian Sea [kæspɪən sɛ'] 70 27
 casserole dish [kæs' ə rɔl dɪʃ/] 30 14
 cassette [kəsɛt] 100 26
 cassette deck [kəsɛt' dɛk/] 100 22
 cast [kæst] 39 5
 cat [kæt] 68 4
 catch [kæch] 96 4
 catcher [kæch' ə] 92 2, 93 16
 catcher's mask [kæch' ərz mæsk/] 92 3
 catcher's mitt [kæch' ərz mɪt/] 92 4
 caterpillar [kæt' ər pɪl' ə] 63 1
 cattle [kæt' əl] 81 20
 Caucasus [kə' kəsəs] 71 45

- cauliflower [kɔl' ə flow' ər] 6 1
 ceiling [sē' lɪŋ] 28 2
 ceiling fan [sē' lɪŋ fən'] 28 1
 celery [sēl' ə rē] 6 10
 cello [chəl' o] 98 9
 cement [sə mənt'] 82 10
 cement mixer [sə mənt' mɪk' sər]
 82 25
 cement truck [sə mənt' trʌk'] 49 13
 center [sɛn' tər] 79 13, 93 27
 center divider [sɛn' tər də vɪ' dər]
 53 18, 82 24
 center fielder [sɛn' tər fɛl' dər] 93 2
 center lane [sɛn' tər lān'] 53 6
 centerboard [sɛn' tər bɔrd'] 59 6
 centipede [sɛn' tə pɛd'] 63 22
 chain [chān] 23 5, 52 18
 chair [chēr] 29 17
 chalk [chɔk] 76 10
 chalk tray [chɔk' trā'] 76 9
 chalkboard [chɔk' bɔrd'] 76 5
 chandelier [shān' də lɪr'] 29 3
 change (the sheets) [chānj' dhə shēts']
 38 13
 changing table [chān' jɪŋ tā' bəl] 33 9
 charcoal briquettes
 [chär' kɔl brɪ kɛts'] 27 23
 chart [chärt] 39 10
 check [chɛk] 15 27, 16 14
 checked [chɛkt] 24 18
 checkout counter [chɛk' owt kown' tər]
 15 26
 checkout desk [chɛk' owt dɛsk'] 47 2
 cheerleaders [chēr' lē' dərz] 93 20
 cheek [chēk] 4 35
 cherries [chēr' ēz] 9 19
 cherry picker [chēr' ē pɪk' ər] 82 18
 chest [chɛst] 4 12
 chest of drawers [chɛst' əv drɔrz']
 32 30
 chestnut(s) [chɛs' nʌt(s)] 9 32
 chick [chɪk] 64 22
 chicken [chɪk' ən] 11 24, 64 23
 child's seat [chɪldz' sēt'] 50 33
 children [chɪl' drən] 2 7
 chills [chɪlz] 40 4
 chimney [chɪm' nē] 27 9
 chimpanzee [chɪm pān' zē] 69 16
 chin [chɪn] 4 3
 china [chī' nə] 29 1
 china closet [chī' nə klɔz' ət] 29 2
 chipmunk [chɪp' mʌnk] 66 6
 chop [chɔp] 26 11, 31 11
 chops [chɔps] 10 9, 10 15
 chorus [kɔr' əs] 99 18
 (chrysanthemum)
 [krə sən' thə məm]/[mʌm] 60 4
 cigarette [sɪg' ə rɛt'] 16 31
 circle [sʌr' kəl] 79 11
 circuit breaker [sʌr' kət brā' kər] 35 5
 circular saw [sʌr' kyə lər sɔ'] 36 20
 circumference [sʌr kʌm' fə rəns] 79 17
 citrus fruits [sɪ' trəs frʊts'] 8
 city [sɪt' ē] 44-45
 clam(s) [klām(z)] 11 32
 clamp [klämp] 78 7
 clarinet [klār' ə nɛt'] 98 16
 clasp [kläsp] 23 17
 classroom [kläs' rōom'] 76
 claw [klɔ] 62 13a, 68 2a
 clean [klēn] 24 6, 26 2
 cleanser [klɛn' zər] 35 9
 clear [klɪr] 17 6
 cliff [klɪf] 89 21
 clip-on earring [klɪp' ɔn ɪr' ɪŋ] 23 15
 clock [klɔk] 76 2
 close (v) [klɔz] 77 5
 closed [klɔzd] 24 16
 closet [klɔz' ət] 32 3
 cloth diaper [klɔth' dɪ' pər] 33 13
 clothes [klɔz] 19-24
 clothesline [klɔz' lɪn'] 35 19
 clothespins [klɔz' pɪnz'] 35 20
 cloudy [klow' dē] 25 2
 clove [klɔv] 7 25a
 cloverleaf [klɔ' vər lɛf'] 53 4
 clubs [klʌbz] 95 5
 clutch [klʌtʃ] 50 25
 coach [kɔtʃ] 93 21
 coal [kɔl] 80 7
 coal mine [kɔl' mɪn] 80 6
 coaster [kɔ' stər] 16 27
 coat [kɔt] 19 24, 42 13
 cob [kɔb] 6 12a
 cobra [kɔ' brə] 65 11
 cockpit [kɔk' pɪt'] 56 13
 cockroach [kɔk' rɔtʃ'] 63 9
 cocktail lounge [kɔk' təl lɔnj'] 16
 cocktail waitress [kɔk' təl wā' trəs]
 16 32
 cocoon [kə kooŋ'] 63 2
 coconut [kɔ' kə nʌt'] 8 3
 coffee [kɔ' fē] 18 35
 coffeemaker [kɔ' fē mā' kər] 30 31
 coffeepot [kɔ' fē pɔt'] 29 18
 coffee table [kɔ' fē tā' bəl] 28 26
 coins [kɔɪnz] 13 26
 colander [kɔl' ən dər] 30 7
 cold [kɔld] 25 10, 40 11
 cold water faucet [kɔld' wɔ tər fə' sət]
 34 18
 collar [kɔl' ər] 20 20
 colonial-style house
 [kə lɔ' nē əl stɪl hɔws'] 27
 Colorado [kɔl' ə rɔd' o] 72 6
 column [kɔl' əm] 50 13
 comb [kɔm] 32 6
 combine (n) [kɔm' bɪn] 81 17
 comet [kɔm' ət] 74 2
 comforter [kʌm' fər tər] 32 22
 command module [kə mänd' mɔj' ool]
 75 8
 communication satellite
 [kə myoo' nə kə shən sət' ə lɪt] 75 2
 commuter [kə myoo' tər] 55 17
 commuter train [kə myoo' tər trān']
 55 14
 compact disc (CD)
 [kɔm' pakt dɪsk']/[sē' dē'] 100 27
 compact disc player
 [kɔm' pakt dɪsk' plā' ər] 100 28
 computer [kəm pyoo' tər] 76 8, 83
 16, 100
 computer programmer
 [kəm pyoo' tər prɔ' grām ər] 86 16
 conductor [kən dʌk' tər] 54 7, 99 8
 cone [kɔn] 61 34b, 79 28, 82 19
 conga [kɔŋg' gə] 98 20
 Congo River [kɔŋg' gɔ rɪv' ər] 71 62
 Connecticut [kə nɛ' tɪ kət] 72 7
 constellation [kɔn' stə lā' shən] 74 3
 construction [kən strʌk' shən] 82
 (construction) boots
 [kən strʌk' shən bōots'] 21 32

- construction site [kən strūk' shən sīt'] 82
 construction worker
 [kən strūk' shən wūr' kər] 82 14
 container [kən tā'nər] 12 2, 58 7
 (container)ship [kən tā'nər shīp'] 58 9
 containers [kən tā'nərz] 12
 continents [kɒn'tə nənts] 70
 control tower [kən trōl'tow'ər] 57 20
 conveyor belt [kən vā'ər bēlt] 15 23,
 56 12
 cook (n) [kʊk] 17 4
 cook (v) [kʊk] 17 4
 cookie [kʊk' ē] 18 22
 cool [kʊl] 25 9
 cooler [kʊl' lər] 91 41
 cooling tower [kʊl' lɪŋg tow'ər] 80 16
 copilot [kō'pī lət] 56 16
 cord [kɔrd] 32 26a, 54 1
 (corduroy) pants [kɔr'də roɪ pənts']
 21 27
 core [kɔr] 8 2b, 80 14
 cork [kɔrk] 16 18
 corkscrew [kɔrk'skrō'] 16 17
 corn [kɔrn] 6 12, 60 24
 corner [kɔr'nər] 44 3
 corral [kə rəl'] 81 24
 cosmetics [kɔz mēt'iks] 23
 cotton balls [kɔt'ən bɔlz'] 39 23
 cotton swab [kɔt'ən swɔb'] 33 10
 counter [kəʊn'tər] 30 27
 court [kɔrt] 43, 94 13
 court officer [kɔrt'ɔ'fɪsər] 43 19
 court reporter [kɔrt'rə pɔr'tər] 43 14
 cousin [kʊz'ən] 3 7
 cow [kəʊ] 67 32
 cowboy [kəʊ'boɪ] 81 21
 cowgirl [kəʊ'gɜrl'] 81 22
 crab(s) [kræb(z)] 11 36, 62 9
 cradle [kræ'dəl] 33 26
 cranberries [krænbēr'ēz] 8 13
 crane [kræn] 58 6
 creamer [krē'mər] 29 24
 crew [krō] 75 12
 (crewneck) sweater
 [krō'nēk swēt'ər] 19 7
 crib [krīb] 33 4
 cricket [krɪk'ət] 63 5
 crime [krɪm] 43
 crochet [krō shā'] 101 28
 crochet hook [krō' shā' hʊk'] 101 29
 crocus [krō'kəs] 60 9
 cross-country skiing
 [krɔs'kʌn trē skē'ɪŋ] 94
 crosswalk [krɔs'wɔk'] 44 4
 crow [krō] 64 3
 crutch [krʊtʃ] 39 7
 cube [kyʊb] 79 27
 cubicle [kyʊb' bə kəl] 83 5
 cucumber(s) [kyʊb' kʌm bər(z)] 7 20
 cuff links [kʌf' lɪŋks'] 23 12
 cup [kʌp] 13 19, 29 20
 curb [kɜrb] 45 26
 curtain [kɜr'tən] 32 10, 99 1
 curtain rings [kɜr'tən rɪŋgz'] 34 2
 curtain rod [kɜr'tən rɔd'] 34 1
 curve [kɜrv] 79 3
 cushion [kʊʃən] 28 24
 customer [kʌs'təmər] 15 17
 cut (v) [kʌt] 31 9
 cut (n) [kʌt] 40 16
 cutting board [kʌt'ɪŋ bɔrd'] 30 26
 cylinder [sɪl'ɪn dər] 79 26
 cymbals [sɪm'bəlz] 98 18
 daffodil [dæf'ədɪl] 60 8
 dairy cow [dɛr'ē kəʊ] 81 11
 dairy farm [dɛr'ē fɑrm] 81
 dairy products [dɛr'ē prɔd'ʌkts] 14 4
 daisy [dā'zē] 60 5
 dam [dæm] 80 18
 dance [dæns] 99
 dancer [dænsər] 99 3
 dark [dɑrk] 24 10
 dashboard [dæʃ'bɔrd'] 50 19
 date [dāt] 9 23
 daughter [dɔ'tər] 3 15
 deck [dɛk] 27 5, 58 22
 deer [dɪr] 67 26
 defendant [də fɛn'dənt] 43 23
 defense attorney [də fɛns'ə tɪr'nē]
 43 22
 Delaware [dɛl'ə wər'] 72 8
 deli counter [dɛl'ē kəʊn'tər] 14 1
 delivery boy [də lɪv'ə rē boɪ] 85 10
 delivery person [də lɪv'ə rē pɜr'sən]
 49 10
 dental care [dɛn'təl kɛr'] 39
 dentist [dɛn'tɪst] 39 17
 department store [də pɑrt'mənt stɔr']
 44 5
 depth [dɛpθ] 79 33
 derrick [dɛr'ɪk] 80 2
 deserts [dɛz'ərts] 71
 desk [dɛsk] 28 14, 76 16, 83 13
 detective [də tɛk'tɪv] 43 2
 diagonal [dɪ'æŋ'ə nəl] 79 20
 diameter [dɪ'æm'ə tər] 79 12
 dictionary [dɪk'shənər'ē] 47 24
 diesel fuel [dɛ'zəl fyū'əl] 80 34
 dig [dɪŋ] 26 3
 dime [dɪm] 13 29
 dinghy [dɪŋ'ɪ] 59 18
 dining room [dɪ'nɪŋ rʊm'] 29
 dipstick [dɪp'stɪk'] 51 58
 dirt bike [dɜrt'bɪk'] 52 8
 disc jockey (DJ) [dɪsk'jɔk'ē]/[dɛ'jɑ]
 86 9
 dirty [dɜr'tɪ] 24 5
 dish drainer [dɪʃ'drā'nər] 30 2
 dish towel [dɪʃ'tow'əl] 30 18
 dishwasher [dɪʃ'wɔʃ'ər] 30 1
 dishwashing liquid
 [dɪʃ'wɔʃɪŋ lɪ'kwɪd] 30 10
 disposable diaper
 [dɪs pə'zə bəl dɪ'pər] 33 12
 dissection kit [dɪ sɛk'shən kɪt'] 78 33
 dive [dɪv] 97 14
 dock [dɔk] 58 28
 doctor [dɔk'tər] 39 11
 dogs [dɔgz] 69
 dogwood [dɔg'wʊd'] 61 28
 doll [dɔl] 33 28
 doll house [dɔl'həʊz'] 33 25
 dollar bills [dɔl'ər bɪlz'] 13 25
 dolly [dɔl'ē] 56 6
 dolphin [dɔl'fɪn] 68 13
 donkey [dɔŋg'kē] 67 23
 door handle [dɔr'hændl'] 50 4
 door lock [dɔr'lɔk'] 50 1
 doorman [dɔr'mən] 85 11
 down [daʊn] 103 3
 down vest [daʊn'vest'] 19 12
 dragonfly [dræŋ'ən flɪ] 63 4
 drain [dræn] 34 9
 drainpipe [dræn'pɪp'] 27 18

- drapes [drāps] 28 23
 draw [drō] 77 11
 drawer [drör] 47 5
 dress [drēs] 20 22
 dried fruits [drīd' frōots'] 9
 drill [drīl] 39 15
 drink [drīngk] 17 2
 drive [drīv] 97 15
 driveway [drīv' wā'] 27 1
 drugstore [drüg' stör'] 45 22
 drum [drüm] 98 19
 drummer [drüm'ər] 99 27
 drumsticks [drüm' stīks'] 98 19a
 dry [drī] 25 14, 38 9
 dryer [drī'ər] 35 24
 duck [dük] 11 25, 64 25
 (duck) pond [dük' pōnd'] 87 8
 dugout [düg' owt'] 93 13
 dump truck [dümp' trük'] 49 14
 dust [düst] 38 15
 dustpan [düst' pän'] 35 8
 eagle [ē' gəl] 64 5
 ear [īr] 4 34
 (ear of) corn [īr' əv kōrn'] 6 12
 earmuffs [īr' müfs'] 19 10
 earrings [īr' īngz] 23 1
 Earth [ürth] 74 8, 13
 east [ēst] 71 73
 East China Sea [ēst' chī' nə sē']
 70 38
 eat [ēt] 17 1
 eel [ēl] 65 4
 egg [ĕg] 18 32, 64 13
 egg roll [ĕg' rōl'] 18 25
 eggplant [ĕg' plānt'] 7 21
 elbow [ĕl' bō] 4 8
 electric drill [ī lĕk' trīk drīl'] 37 43
 electric guitar [ī lĕk' trīk gī tār']
 99 26
 electric generator
 [ī lĕk' trīk gĕn' ə rā tər] 80 21
 electrical tape [ī lĕk' trī kəl tāp']
 37 34
 electrician [ī lĕk trī' shən] 85 6
 electricity [ī lĕk trīs' ī tē] 80 32
 electronics [ī lĕk trōn' īks] 100
 elephant [ĕl' ə fənt] 66 17
 elevator [ĕl' ə vā' tər] 45 17, 80 9
 elm [ĕlm] 61 36
 embroidery [ĕm broi' də rē] 101 27
 emergency brake [ī mūr' jən sē brāk']
 50 15
 emery board [ĕm' ə rē bōrd'] 23 24
 encyclopedia [ĕn sī' klə pē' dē ə] 47 25
 end table [ĕnd' tā' bəl] 28 29
 end zone [ĕnd' zōn'] 93 23
 energy [ĕn' ər jē] 80
 engagement ring [ĕn gāj' mənt rīng']
 23 3
 engine [ĕn' jən] 51, 52 32
 engineer [ĕn' jə nūr'] 55 15
 enter [ĕn' tər] 77 14
 entrance ramp [ĕn' trəns rāmp'] 53 21
 envelope [ĕn' və lōp'] 46 16, 83 31
 equator [ī kwā' tər] 71 70
 erase [ī rās'] 77 3
 eraser [ī rā' sər] 76 11
 escarole [ĕs' kə rōl'] 6 7
 esophagus [ī sōf' ə gəs] 5 61
 eucalyptus [yōō' kə līp' təs] 61 27
 Europe [yōōr' əp] 70 3
 examining table [īg zām' ə nīng tā' bəl]
 39 6
 exhaust pipe [īg zōst' pīp'] 52 33
 exit ramp [ĕg' zīt rāmp'] 53 2
 exit sign [ĕg' zīt sīn'] 53 24
 Express Mail (package)
 [īk sprēs' māl pāk' ij] 46 23
 extension cord [īk stĕn' shən kōrd']
 36 5
 eye [ī] 5
 eye drops [ī' drōps'] 41 10
 eye shadow [ī' shā' dō] 23 30
 eyebrow [ī' brow'] 5 44
 eyebrow pencil [ī' brow pĕn' səl]
 23 26
 eyelashes [ī' lāsh' əz] 5 46
 eyelid [ī' līd'] 5 45
 eyeliner [ī' lī' nər] 23 33
 fabric softener [fāb' rīk sō' fə nər]
 35 27
 face [fās] 4 1
 face guard [fās' gārd'] 92 15
 factory work [fāk' tə rē wūr'k'] 85
 fairway [fēr' wā'] 95 12
 fall [fōl] 96 7
 Fall [fōl] 26
 family [fām' ə lē] 3
 family restaurant [fām' ə lē rēs' tər ənt]
 16
 fan belt [fān' bĕlt'] 51 53
 fare [fēr] 55 21
 fare box [fēr' bōks'] 54 5
 farmhouse [fārm' hōws'] 81 3
 farmer [fār' mər] 81 7
 farming [fār' mīng] 81
 fashion designer [fāsh' ən də zī' nər]
 86 6
 father [fōdh' ər] 3 5
 faucet [fō' sīt] 34 17, 18
 fawn [fōn] 67 27
 feather [fĕdh' ər] 64 7a
 feather duster [fĕdh' ər dūs' tər] 35 2
 fence [fĕns] 81 9
 fender [fĕn' dər] 52 10
 ferry [fēr' ē] 58 17
 fever [fē' vər] 40 2
 field [fĕld] 81 16
 fields and courses [fĕldz' ənd kōr' səz]
 95
 fig [fīg] 9 21
 fighter plane [fī' tər plān'] 48 1
 file cabinet [fīl' kāb' ə nət] 83 21
 file clerk [fīl' klūr'k'] 83 23
 file folder [fīl' fōl' dər] 83 22
 filet [fī lā'] 11 28
 fill [fīl] 26 9
 film [fīlm] 100 10, 100 17
 filter paper [fīl' tər pā' pər] 78 16
 fin [fīn] 65 3b
 finger [fīng' gər] 4 25
 fingernail [fīng' gər nāl'] 4 23
 fingerprints [fīng' gər prīnts'] 43 24
 finish line [fīn' īsh līn'] 95 21
 fire [fīr] 28 9, 42 5
 fire engine [fīr' ĕn' jən] 42 2
 fire escape [fīr' ə skāp'] 42 4
 fire extinguisher
 [fīr' īk stīng' gwī shər] 42 11
 fire fighter [fīr' fī' tər] 42 10
 fire hydrant [fīr' hī' drənt] 42 9
 fire truck [fīr' trük'] 42 3
 firefighting [fīr' fī' tīng] 42
 firefly [fīr' flī'] 63 17

- fireplace [fɪr'plās/] 28 8
 first baseman [fɪrst'bās'mən] 93 8
 first quarter [fɪrst'kwɔr'tər] 74 23
 fish [fɪʃ] 11 26, 65
 fisherman [fɪʃ'ər mən] 58 2
 fishing [fɪʃ'ɪŋ] 88
 fishing boat [fɪʃ'ɪŋ bōt/] 58 1
 fishing line [fɪʃ'ɪŋ lɪn/] 88 8
 fishing net [fɪʃ'ɪŋ nɛt/] 88 9
 fishing rod [fɪʃ'ɪŋ rɔd/] 88 7
 flag [flæg] 76 1, 82 20, 95 9
 flame [flām] 29 26, 78 21
 flamingo [flə mɪŋ'gō] 64 29
 flanker [flæŋ'kər] 93 31
 flannel shirt [flæn'əl ʃɪrt/] 19 3
 flare [flɛr] 51 41
 flash [flæʃ] 100 7
 flashlight [flæʃ'laɪt/] 35 3
 flask [flæsk] 78 2
 (flat) sheet [flæt'shɛt/] 32 19
 flatbed [flæt'bɛd/] 49 18
 flight attendant [flaɪt'ətɛn'dənt] 56 20
 flight deck [flaɪt'dɛk/] 75 10
 flight engineer [flaɪt'ɛnʒɪnɪr/] 56 17
 flipper [flɪp'ər] 68 12a
 flippers [flɪp'ərz] 91 36
 floor [flɔr] 32 29
 Florida [flɔr'ə də] 72 9
 florist [flɔr'ɪst] 84 11
 flounder [flaʊn'dər] 65 7
 flowers [flaʊ'ərz] 60
 flute [flūt] 99 13
 fly [flaɪ] 63 18
 flying mammal [flaɪ'ɪŋ mæ'mælz] 66
 foal [fōl] 67 22
 foggy [fɔg'ē] 25 12
 fold [fōld] 38 1
 food [fūd] 6-18
 foot [fūt] 5
 football [fūt'bōl/] 92, 92 13
 football field [fūt'bōl fɛld/] 93
 forceps [fɔr'sɒps] 78 28
 forearm [fɔr'ɑrm/] 4 9
 forehead [fɔr'hɛd/] 4 32
 forelegs [fɔr'lɛgz/] 66 3d
 foreman [fɔr'mən] 85 13
 fork [fɔrk] 29 12
 forklift [fɔrk'lɪft/] 58 4
 foul line [faʊl'lɪn/] 93 9
 foundation [faʊn dā'shən] 82 11
 four-door hatchback [fɔr'dɔr hæch'bæk] 51
 fox [fɔks] 68 6
 fractions [fræk'shənz] 79
 frame [frām] 28 4
 frame backpack [frām'bæk'pæk] 89 28
 freezer [frē'zɔr] 14 3, 30 20
 freezing [frē'zɪŋ] 25 11
 french fries [frɛnch'frɪz/] 18 28
 French horn [frɛnch'hɔrn/] 98 26
 fried chicken [frɪd'chɪk'ən] 18 29
 Frisbee™ [frɪz'bē] 90 13
 frog [frɔg] 65 17
 from [frʊm] 103 10
 front bumper [frʊnt'bʊm'pɛr] 51 51
 frozen foods [frɔ'zən fūdz/] 14 2
 fruit and vegetable market [frūt'ænd vɛj'tə bəl mār'kæt] 44 28
 fruit tree [frūt'trē/] 81 2
 fruits [frūts] 8
 fry [fraɪ] 31 15
 frying pan [fraɪ'ɪŋ pæn/] 30 5
 fuel truck [fyū'əl trʊk/] 49 3
 full moon [fūl'mūn/] 74 24
 full slip [fūl'slɪp/] 22 10
 fullback [fūl'bæk/] 93 34
 funnel [fʊn'əl] 78 17
 fuselage [fyū'sə lɔj/] 57 14
 galaxy [gæl'æk sē] 74 1
 Ganges River [gæn'jɛz rɪv'ər] 71 67
 gangway [gæŋ'wā/] 58 20
 garage [gə rɔj/] 27 2
 garbage can [gær'bɪj kæn/] 35 31
 garbage truck [gær'bɪj trʊk/] 49 6
 garden hose [gær'dən hɔs/] 27 14
 gardenia [gær dɛn'yə] 60 14
 gardener [gærd'nɛr] 85 3
 garlic [gær'lɪk] 7 25
 garment bag [gær'mənt bæɡ/] 56 1
 garter belt [gær'tɛr bɛlt/] 22 14
 (garter) snake [gær'tɛr snæk/] 65 9
 gas gauge [gæs'gāj/] 50 9
 gas pump [gæs'pʊmp/] 53 14
 gas tank [gæs'tæŋk/] 50 34
 gas(oline) [gæs'əlɛn/] 80 28
 (gauze) bandage [gɔz'bænd'ɪdʒ] 39 24
 gauze pads [gɔz'pædz/] 39 25
 gavel [gæv'əl] 43 12
 gear [gɪr] 89 27
 gear changer [gɪr'chæŋ'jɔr] 52 22
 gearshift [gɪr'shɪft/] 50 17
 geometrical figures [jē'ə mɛ'trɪ kəl fɪg'yɔrz] 79
 Georgia [jɔr'jə] 72 10
 geyser [gɪ'zɔr] 80 5
 gibbon [gɪb'ən] 69 15
 gill [gɪl] 65 3c
 giraffe [jə ræf/] 67 29
 girdle [gɪr'dəl] 22 15
 girl [gɪrl] 2 9
 girl's frame [gɪrlz'frām/] 52 3
 give [gɪv] 17 9
 glass [glæs] 12 20
 glasses [glæs'əz] 21 44
 glider [glɪ'dɛr] 57 4
 globe [glɔb] 47 19
 glove [glʊv] 92 12, 94 11, 94 15
 glove compartment [glʊv'kəm pɑrt'mənt] 50 20
 gloves [glʊvz] 19 1
 glue [glū] 36 33, 76 17
 goal [gōl] 92 25
 goalie [gōl'ē] 92 24
 goalpost [gōl'pɔst/] 93 35
 goat [gōt] 67 28
 Gobi Desert [gō'bē dɛz'ɛrt] 71 54
 golf [gɔlf] 94
 golf bag [gɔlf'bæg/] 95 7
 golf ball [gɔlf'bɔl/] 94 7
 golf cart [gɔlf'kɑrt/] 95 8
 golf course [gɔlf'kɔrs/] 95
 golfer [gɔl'fɛr] 94 10
 goose [gūs] 64 26
 gooseberries [gūs'bɛr'ɛz] 8 11
 gopher [gō'fɛr] 66 8
 gorilla [gə rɪl'ə] 69 17
 graduated cylinder [græj'ōō ā tɪd sɪl'ən dɛr] 78 25
 grains [grānz] 60
 granddaughter [grænd'dɔ'tɔr] 2 11
 grandfather [grænd'fɔ'dhɛr] 3 2
 grandmother [grænd'mʊ'dhɛr] 3 1
 grandparents [grænd'pɑr'ɛnts] 2 10
 grandson [grænd'sʊn/] 2 12

- grapefruit [gräp' frōot'] 8 7
 grapes [gräps] 8 1
 graph paper [gräf' pā' pər] 78 11
 grass [gräs] 27 15
 grasses [gräs' əz] 60
 grasshopper [gräs' hōp' ə] 63 6
 grate [grāt] 31 2
 Great Sandy Desert
 [grāt' sän' dē dēz' ərt] 71 55
 green [grēn] 95 10
 greengrocer [grēn' grō' sər] 84 7
 grill [gril] 27 22, 88 12
 grizzly bear [griz' lē bēr'] 69 23
 groceries [grō' sə rēz] 15 24
 ground beef [grownd' bēf'] 10 2
 grounding plug [grown' dīng plūg']
 36 7
 guitar [gī tär'] 98 11
 Gulf of Alaska [gūlf' əv ə lās' kə]
 70 17
 Gulf of Guinea [gūlf' əv gīn' ē] 70 25
 Gulf of Mexico [gūlf' əv mēk sə kō]
 70 19
 gulfs [gūlfs] 70
 gun [gūn] 43 7
 gun turret [gūn' tür' ət] 48 12
 gutter [gūt' ə] 27 10, 94 3
 gymnast [jīm' nəst] 94 23
 gymnastics [jīm nās' tīks] 94
 hacksaw [hāk' sō'] 36 18
 hair [hēr] 4 30
 hair dryer [hēr' drī' ə] 34 26
 hairbrush [hēr' brūsh'] 32 7
 hairdresser [hēr' drēs' ə] 84 10
 half (1/2) [häf] 79 30
 half slip [häf' slīp'] 22 8
 halfback [häf' bāk'] 93 33
 hall [hōl] 76 12
 ham [häm] 10 12
 hamburger [häm' bür' gər] 18 9
 hammer [häm' ə] 36 13
 hammock [häm' ək] 27 11
 hamper [häm' pər] 34 28
 hand [händ] 4
 hand brake [händ' brāk'] 52 24
 hand grenade [händ' grə nād'] 48 29
 hand towel [händ' tow' əl] 34 23
 hand truck [händ' trūk'] 87 4
 handball [händ' bōl'] 94, 94 12
 handcuffs [händ' küfs'] 43 4
 handicrafts [hän' dē kräfts'] 101
 handlebars [hän' dəl bärz'] 52 2
 hang [häng] 38 6
 hang glider [häng' glī' dər] 57 6
 hangar [häng' ə] 57 17
 hanger [häng' ə] 32 2
 hard hat [händ' hăt'] 21 28, 82 4
 harmonica [här mōn' ə kə] 98 30
 harness [här' nəs] 89 22
 harp [härp] 98 6
 hat [hăt] 19 18
 hatchback [häch' bāk'] 51 43
 hatchet [häch' ət] 36 17
 Hawaii [hə wō' ē] 72 11
 hawk [hök] 64 7
 hay [hā] 81 13
 hazelnut(s) [hā' zəl nüt(s)'] 9 30
 head [hēd] 4, 36 42a
 (head of) cauliflower
 [hēd' əv kōl ə flow' ə] 6 1
 head protector [hēd prə tēk' tər] 94 14
 headache [hēd' āk'] 40 6
 headboard [hēd' bōrd'] 32 14
 headlights [hēd' līt's'] 51 48
 headphones [hēd' fōnz'] 100 29
 headrest [hēd' rēst'] 50 35
 headset [hēd' sēt'] 83 2
 heart [härt] 5 64
 heat [hēt] 80 27
 heating pad [hē' tīng pād'] 41 3
 hedge clippers [hēj' klīp' ərz] 27 29
 heel [hēl] 5 50, 20 5
 heels [hēlz] 20 25
 height [hīt] 79 34
 helicopter [hēl' ə kōp' tər] 57 2
 helmet [hēl' mət] 42 12, 52 7, 92 14
 hem [hēm] 101 11
 hem binding [hēm' bīn' dīng] 101 12
 herb(s) [ürb(z)] 6 9
 (herd of) cattle [hürd' əv kät' əl] 81 20
 high [hī] 24 11
 high blood pressure [hī' blūd prēsh' ə]
 40 10
 high chair [hī' chēr'] 16 8
 high heels [hī' hēlz'] 20 25
 highway travel [hī' wā trāv' əl] 53
 hikers [hī' kərz] 88 2
 hiking boots [hī' kīng bōots'] 19 9
 hill [hīl] 88 4
 Himalayas [hīm' ə lā' əz] 70 47
 hind legs [hīnd' lēgz'] 66 3b
 hip [hīp] 4 16
 hippopotamus [hīp' ə pōt' ə məs]
 66 14
 hit [hīt] 96 1
 hitchhiker [hīch' hī' kər] 53 9
 hockey stick [hök' ē stīk'] 92 18
 hog [hög] 66 30
 hold [hōld] 17 12, 58 8
 hole [hōl] 94 8
 holly [hōl' ē] 61 37
 holster [hōl' stər] 43 8
 home plate [hōm' plāt'] 93 15
 honeydew melon
 [hūn' ē dōō mēl' ən] 9 35
 hood [hōōd] 51 47
 hoof [hōōf] 66 35b
 hoofed mammals [hōōft' mām' əlz] 66
 hook [hōōk] 32 1, 36 16
 hook and eye [hōōk' ənd ī'] 101 14
 horn [hörn] 50 12, 52 5, 66 16a
 horse [hōrs] 66 21
 horse racing [hōrs' rā' sīng] 94
 horse-drawn carriage
 [hōrs' drōn kār' ij] 54 33
 horseback rider [hōrs' bāk rī' dər]
 87 6
 horses [hōrs' əz] 81 23
 hose [hōz] 42 8, 50 57.
 hot [hōt] 25 7
 hot air balloon [hōt' ēr bə lōōn'] 57 1
 hot dog [hōt' dōg'] 18 2
 hot water faucet [hōt' wōt əf fō' sət]
 34 17
 house plants [hows' plānts'] 60 39
 household items [hows' hōld ī' təmz]
 15 15
 household services
 [hows' hōld sūr' və səz] 85
 housekeeper [hows' kē' pər] 85 8
 houses [how' zəz] 27
 housework [hows' würk'] 38
 Huang River [hwōng' riv' ə] 71 68
 hubcap [hüb' kăp'] 50 36

- Hudson Bay [hʌd'sən bɑː] 70 18
 human body [hyʊən mən bɒdɪ] 4
 hummingbird [hʌm'ɪŋ bɜːd] 64 2
 hump [hʌmp] 67 33a
 husband [hʌz'bʌnd] 2 3, 3 12
 hyacinth [hɪ'ə sɪnth] 60 10
 hyena [hɪ'e'nə] 68 30
 hypotenuse [hɪ pɒt'ə nōʊs] 79 24
 ice cream cone [ɪs'krēm cōn] 18 36
 ice hockey [ɪs'hɒk'ē] 92
 ice pack [ɪs'pæk] 41 4
 ice skates [ɪs'skɑːts] 19 15
 ice skating [ɪs'skɑːtɪŋ] 94
 ice tray [ɪs'trɑː] 30 21
 icy [ɪ'seɪ] 25 16
 Idaho [ɪ'də hoʊ] 72 12
 ignition [ɪg'nɪʃən] 50 14
 iguana [ɪ'gwɔːnə] 65 13
 Illinois [ɪl'ə noɪ] 72 13
 in [ɪn] 102 7
 in front of [ɪn frʌnt'əv] 102 6
 in-box [ɪn'bɒks] 83 12
 (index) finger [ɪn'dɛks fɪŋ'gər] 4 25
 Indian Ocean [ɪn'deɪən oʊ'shən] 70 13
 Indiana [ɪn'deɪənə] 72 14
 individual sports
 [ɪn'də vɪj'ə spɔːrts] 94
 infection [ɪn'fɛkʃən] 40 14
 inflatable raft [ɪn flə'tə bəl rɑːft] 59 20
 information desk
 [ɪn'fɔːməʃən dɛsk] 47 22
 injection [ɪn'jɛkʃən] 41 8
 injuries [ɪn'jʊəri] 40
 insect bite [ɪn'sɛkt baɪt] 40 3
 insects [ɪn'sɛkts] 63
 instep [ɪn'stɛp] 5 51
 instruments [ɪn'strəmənts]
 39 13, 56 14, 98
 internal organs [ɪn'tɪr'nəl ɔː'gɑːnz] 5
 intersection [ɪn'tɛr'sɛkʃən] 44 11
 interstate highway
 [ɪn'tɛr stɑːt hɪ'wɑː] 53 1
 intestines [ɪn'tɛs'tɛnz] 5 67
 into [ɪn'tuː] 103 12
 Iowa [ɪ'ə wə] 72 15
 iris [ɪ'rɪs] 5 47, 60 11
 iron (n) [ɪ'ɔːn] 35 12
 iron (v) [ɪ'ɔːn] 38 11
 ironing board [ɪ'ɔːnɪŋ bɔːrd] 35 13
 jack [jæk] 32 26b, 50 38
 jacket [jæk'ət] 19 17, 21 33
 jackhammer [jæk'hæm'ər] 82 22
 jail [jæl] 43 1
 janitor [jæn'ə tər] 85 9
 jar [jɑː] 12 9
 jaw [jəʊ] 4 38
 jeans [jɛnz] 19 6
 jeep [jɛp] 48 9
 jelly [jɛl'ē] 18 31
 jellyfish [jɛl'ē fɪʃ] 62 12
 jet engine [jɛt'ɛn'jɛn] 57 11
 jet fuel [jɛt'fyʊəl] 80 31
 (jet) plane [jɛt'plæn] 57 18
 jeweller [jʊəl'ər] 84 12
 jewelry [jʊəl'rɪ] 23
 jewelry box [jʊəl'rɪ bɒks] 32 4
 jigsaw [jɪg'sɔː] 36 3
 jockey [jɒk'ē] 94 21
 jogging path [jɒg'ɪŋ pɑːθ] 87 9
 judge [dʒʌdʒ] 43 10
 jukebox [jʊk'bɒks] 16 12
 jump [dʒʌmp] 96 8
 jungle gym [dʒʌŋg'əl dʒɪm] 87 17
 Jupiter [dʒʊpɪ'tər] 74 15
 jury [dʒʊəri] 43 21
 jury box [dʒʊəri bɒks] 43 20
 kangaroo [kæŋg'ə rʊ] 66 3
 Kansas [kænzəs] 72 16
 Kara Sea [kɑː'seɪ] 70 31
 kayak [kɑːk] 59 17
 Kentucky [kɛn'tʌk'ē] 72 17
 ketchup [kɛtʃ'əp] 16 4
 kettledrum [kɛt'əl drʌm] 98 21
 keyboard [kɛ'bɔːrd] 98 1a, 100 33
 keyboard player [kɛ'bɔːrd plɛ'ər] 99 22
 kickstand [kɪk'stænd] 52 9
 kidney [kɪd'nɪ] 5 70
 kidney bean(s) [kɪd'nɪ bɛn(z)] 6 13
 kitchen [kɪtʃ'ən] 30
 kite [kaɪt] 91 22
 kitten [kɪt'ən] 68 5
 knee [neɪ] 4 19
 knee socks [neɪ'sɒks] 22 16
 knife [naɪf] 29 15
 knitting [nɪt'ɪŋ] 101 22
 knitting needle [nɪt'ɪŋ neɪ'dəl] 101 25
 knuckle [nʌk'əl] 4 22
 koala [kə'ɔːlə] 66 1
 label [læ'bəl] 46 21
 lacrosse [ləkrɒs] 92
 lacrosse stick [ləkrɒs'stɪk] 92 16
 ladder [læd'ər] 42 1, 82 8
 ladybug [læ'deɪ bʌg] 63 14
 lamb [læm] 10 13, 67 24
 lamp [læmp] 28 28
 lampshade [læmp'shæd] 28 27
 landing gear [lændɪŋ'gɪər] 57 15
 lane [leɪn] 94 4
 lantern [lænd'ən] 88 29
 lapel [ləpəl] 20 1
 Laptev Sea [ləp'tev seɪ] 70 33
 last quarter [lɑːst'kwɔːtər] 74 25
 launchpad [lɒntʃ'pæd] 75 15
 laundry [ləndrɪ] 35 28
 laundry basket [ləndrɪ bɑːskɛt] 35 29
 laundry detergent [ləndrɪ dətɪ'rɪjənt]
 35 25
 lawn mower [lənməʊ'ər] 27 12
 lead guitarist [liːd'gɪtərɪst] 99 25
 leaf [liːf] 60 36a
 leave [liːv] 77 13
 left fielder [lɛft'fiːldər] 93 1
 left guard [lɛft'gɑːrd] 93 26
 left lane [lɛft'leɪn] 53 5
 left tackle [lɛft'tæk'əl] 93 25
 leg [lɛg] 4 17, 10 14, 11 20
 (legal) pad [liːgəl pæd] 83 26
 lemon [lɛm'ən] 8 9
 Lena River [leɪ'nə rɪv'ər] 71 66
 length [lɛŋθ] 79 36
 lens [lɛnz] 100 6
 leopard [lɛp'ərd] 68 1
 letter [lɛt'ər] 46 7
 letter carrier [lɛt'ər kærɪ'jər] 46 3
 lettuce [lɛt'sɪs] 6 6
 level [lɛv'əl] 82 3
 librarian [lɪbrɪ'ɛən] 47 23
 library card [lɪbrɪ'ɛ kɑːrd] 47 3
 library clerk [lɪbrɪ'ɛ klɜːk] 47 1
 license plate [lɪ'sɛns plæt] 50 28
 lid [lɪd] 30 9
 life jacket [laɪf'jæk'ət] 59 1
 life preserver [laɪf'prɛzər'veɪ] 90 9
 lifeboat [laɪf'bɔːt] 58 19, 90 10

- lifeguard [lɪf'gɑ:rd/] 90 6
lifeguard chair [lɪf'gɑ:rd'tʃeə/] 90 8
light (v) [laɪt] 17 13
light (adj) [laɪt] 24 9
light switch [laɪt'swɪtʃ/] 32 25
lightbulb [laɪt'bʊlb/] 35 22
lighter [laɪ'teə] 16 30
lighthouse [laɪt'həʊs/] 58 14
lily [lɪl'i:] 60 3
lima bean(s) [lɪ'mə'bi:n(z)/] 6 16
lime [laɪm] 8 10
line [laɪn] 58 25
lines [laɪnz] 79
linesman [laɪnz'mən] 82 17
lion [laɪ'ən] 68 3
lip [lɪp] 4 43
lipstick [lɪp'stɪk/] 23 29
liquor (bottle) [lɪk'ər'bɒt'əl] 16 22
listen [lɪs'ən] 77 6
little finger [lɪt'əl'fɪŋg'gər] 4 28
little league baseball [lɪt'əl'lēg'bās'bɔ:l] 92
Little Leaguer [lɪt'əl'lēg'ər] 92 8
little toe [lɪt'əl'təʊ/] 5 55
liver [lɪv'ər] 5 65
livestock [lɪv'stɒk/] 81 12
living quarters [lɪv'ɪŋkwɔ:rtəz] 75 11
living room [lɪv'ɪŋrʊm/] 28
lizard [lɪz'əd] 65 15
llama [ləm'ə] 66 15
loaf [ləf] 12 7
loafer [lə'fɛə] 21 42
lobby [ləb'i:] 44 2
lobster [ləb'stɜ:] 10 30, 62 13
lock [lək] 52 13
locker [lək'ər] 76 6
locksmith [lək'smɪθ/] 85 4
log [ləg] 28 10
long [lɒŋ] 24 2
long johns [lɒŋg'ʒɒnz/] 22 7
long sleeve [lɒŋg'slēv/] 20 15
loose [lu:əs] 24 4
(loose-leaf) paper [lu:əs'lēf'pæ'pɜ:] 76 13
loudspeaker [ləʊd'spē'kɜ:] 76 3
Louisiana [lu:ə'e'zē'æn'ə] 72 18
lounge chair [ləʊnʒ'tʃeə/] 27 24
low [ləʊ] 24 12
lunar eclipse [lu:nə'əkli:ps/] 74 6
lunar module [lu:nə'mɔ:ldʒ'ɔ:əl] 75 7
lunch box [lʌntʃ'bɒks/] 20 31
lunch truck [lʌntʃ'trʌk/] 49 8
lung [lʌŋ] 5 63
machine gun [mə'shēn'gʌn/] 48 25
magazine [mæg'ə'zēn/] 47 16
magnet [mæg'nət] 78 27
magnifying glass [mæg'nə'fɪŋg'glɑ:s/] 78 15
magnolia [mæg'nɔ:l'jə] 61 29
mail [meɪl] 46 2
mail slot [meɪl'slɒt/] 46 13
mail truck [meɪl'trʌk/] 46 5
mailbag [meɪl'bæg/] 46 4
mailbox [meɪl'bɒks/] 46 1
Maine [meɪn] 72 19
maintenance [meɪn'teɪnəns] 95
make (the bed) [meɪk'dhə'bɛd/] 38 8
makeup [meɪk'ʌp/] 23
mallet [mæ'lɪt] 36 11
mammals [mæm'ælz] 66-69
man [mæn] 2 2
manager [mæn'ɪjɜ:] 83 18
mandolin [mæn'də'lɪn/] 98 4
mane [meɪn] 66 21a
mango [mæŋg'gəʊ] 8 5
manhole [mæn'həʊl/] 45 32
mantel [mæn'təl] 28 7
mantis [mæn'tɪs] 63 7
manual transmission [mæn'ju:əl'trænz'mɪʃ'ən] 50
map [mæp] 70
maple [mæ'pəl] 61 38
marigold [mæ'rɪgəʊld/] 60 6
marine [mə'reɪn/] 48 18
Marines [mə'reɪnz/] 48 17
Mars [mɑ:z] 74 14
Maryland [mə'rɪə'lænd] 72 20
mascara [mæ'skæ'rə] 23 28
mashed potatoes [mæʃt'pə'teɪtəʊz] 18 17
mask [mæsk] 91 35
Massachusetts [mæs'ətʃoo'sɪts] 72 21
mast [mæst] 59 8
mat [mæt] 50 22
matches [mætʃ'əz] 16 28
material [mə'tɪr'ɪəl] 101 4
math [mæθ] 79
mattress [mæ'tres] 32 17
measurement [meʒh'ər'mɛnt] 79
meat [meɪt] 10
meatballs [meɪt'bɔ:lz/] 18 11
mechanic [mə'kæn'ɪk] 84 2
media [me'di:] 86
medical care [med'əkəl'keə/] 39
medicine [med'əsən] 41
medicine chest [med'əsən'tʃɛst/] 34 14
medicine dropper [med'əsən'drɒp'ər] 78 26
Mediterranean Sea [med'ɪtə'reɪ'nē'ən'si:] 70 24
melon [mel'ən] 9 35
menu [men'yʊ:] 16 7
Mercury [mɜ:'kjʊərə] 74 11
merry-go-round [mɛr'ēgə'raʊnd/] 87 5
message pad [mes'ɪj'pæd/] 83 25
messenger [mes'ənʒər] 86 19
metal detector [met'əl'də'tɛk'tər] 56 10
meteor [me'teə] 74 5
meter [me'tər] 55 23
mezzanine [mez'ənēn/] 99 13
Michigan [mɪʃh'ə'gən] 72 22
microfilm [mɪ'krə'fɪlm/] 47 13
microfilm reader [mɪ'krə'fɪlm're'dər] 47 14
microscope [mɪ'krə'skɒp/] 78 30
microwave oven [mɪ'krə'weɪv'ʊv'ən] 30 23
middle finger [mɪd'əl'fɪŋg'gər] 4 26
milk [mɪlk] 14 5
Minicam™ [mɪn'ē'kæm/] 100 2
Minnesota [mɪn'əsə'tə] 72 23
mirror [mɪr'ər] 32 5
Mississippi [mɪs'əsɪp'i:] 72 24
Mississippi River [mɪs'əsɪp'i:'rɪv'ər] 71 58
Missouri [mɪ'zɔ:ri:] 73 25
mitt [mɪt] 27 20
mittens [mɪt'ənz] 19 11

- mixed vegetables [mɪkst'vɛj'təbɔlz] 18 16
 mixing bowl [mɪk'sɪŋbɔl'] 30 24
 mobile [mō'bēl] 33 2
 model [mɒd'əl] 86 5
 Mojave Desert [mō'hɒv'ēdɛz'ɔrt] 71 48
 money [mʌn'ē] 12
 money order [mʌn'ē'ɔr'dɔr] 46 18
 monitor [mɒn'ətər] 100 32
 monkey [mʌŋg'ke] 69 14
 monkey wrench [mʌŋg'kē'rɛnʃ'] 36 12
 monorail [mɒn'ətə'rāl'] 55 29
 Montana [mɒntən'ə] 73 26
 Moon [mūn] 74 9
 mooring [mūr'ɪŋ] 59 19
 moose [mūs] 67 35
 mop [mɒp] 35 6
 (mop) refill [mɒp'rē'fɪl] 35 11
 mortar [mɔr'tər] 48 28
 mosquito [məskē'tō] 63 13
 motel [mōtəl'] 90 3
 moth [mɒθ] 63 21
 mother [mʌdh'ər] 3 4
 motor oil [mɔt'ərɔɪl'] 80 33
 motor scooter [mɔt'ərskū'tər] 52 29
 motorboat [mɔt'ərbɔt'] 59 13
 motorcycle [mɔt'ərsɪ'kəl] 52 30, 53 19
 mountain [maʊn'tən] 89 19
 mountain climbing [maʊn'tənklɪm'ɪŋ] 89
 mountain ranges [maʊn'tənraŋ'jɛz] 71
 mouse [maʊs] 66 9
 mousetrap [maʊs'træp'] 35 32
 mouth [maʊθ] 4 2
 mover [mūvər] 49 12
 movie camera [mūv'vəkəm'ərə] 100 15
 moving van [mūv'vɪŋvæn'] 49 11
 mow [mō] 26 6
 mum [mʌm] 60 4
 muscle [mʌs'əl] 5 62
 mushroom(s) [mʌʃ'rūm(z)] 7 30
 music [myūzɪk] 99
 musical comedy [myūzɪkəl'kɒm'ədē] 99
 musical instruments [myūzɪkəl'ɪn'strəmənts] 98
 musician [myūzɪʃ'ən] 99 10
 mussel(s) [mʌs'əl(z)] 11 34, 62 3
 mustache [mʌs'tæʃ] 4 40
 mustard [mʌs'tɔrd] 18 1
 nail [nāl] 37 41
 nail clippers [nāl'klɪp'ɔrz] 23 31
 nail polish [nāl'pɒl'ɪʃ] 23 25
 nailbrush [nāl'brʌʃ] 34 20
 napkin [næp'kɪn] 29 14
 natural gas [nætʃ'ərəl'gæs'] 80 29
 Navy [nā've] 48 13
 Nebraska [nəbrəs'kə] 73 27
 neck [nɛk] 4 4
 necklace [nɛk'lɪs] 23 6
 nectarine [nɛk'tərɛn'] 8 17
 needle [nē'dəl] 39 26, 60 34a, 101 18
 needlecrafts [nē'dəlkræfts'] 101
 needlepoint [nē'dəlpɔɪnt'] 101 26
 neighborhood parks [nā'bər'hūdpærks'] 87
 nephew [nɛf'yū] 3 13
 Neptune [nɛp'tūn] 74 18
 nest [nɛst] 64 31
 net [nɛt] 92 23
 Nevada [nəvəd'ə] 73 28
 new [nū] 24 13
 New Hampshire [nū'hæmp'shər] 72 29
 New Jersey [nū'jɜr'ze] 73 30
 New Mexico [nū'mɛksə'kō] 73 31
 new moon [nū'mūn'] 74 26
 New York [nū'yɔrk'] 73 32
 newscaster [nūz'kæs'tər] 86 2
 newspaper [nūz'pæ'pər] 21 48
 newsstand [nūz'stænd'] 45 30
 next to [nɛkst'tū] 102 11
 nickel [nɪk'əl] 13 28
 niece [nēs] 3 14
 Niger River [nī'jərɪv'ər] 71 61
 night table [nɪt'tā'bəl] 32 27
 nightgown [nɪt'gəʊn'] 22 21
 nightstick [nɪt'stɪk'] 43 9
 Nile River [nīl'ɪv'ər] 71 63
 nipple [nɪp'əl] 33 18
 north [nɔrθ] 71 71
 North America [nɔrθ'əmər'əkə] 70 1
 North Atlantic [nɔrθ'æt'læn'tɪk] 70 11
 North Carolina [nɔrθ'kærəlɪ'nə] 73 33
 North Dakota [nɔrθ'dəkō'tə] 73 34
 North Pacific [nɔrθ'pə'sɪf'ɪk] 70 9
 North Sea [nɔrθ'sē'] 70 21
 nose [nōz] 4 36, 57 8
 nostril [nɔs'trɪl] 4 37
 nozzle [nɔz'əl] 42 17
 nuclear reactor [nū'klɛər'reæktər] 80 13
 nurse [nɜrs] 39 19
 nut [nʌt] 37 39
 nuts [nʌts] 9
 oak [ōk] 61 33
 oar [ɔr] 59 22
 oarlock [ɔr'lɔk'] 59 21
 oats [ōts] 60 23
 Ob River [ɔb'ɪv'ər] 71 64
 oboe [ō'bō] 98 15
 obtuse angle [ɔbtū's'æŋ'gəl] 79 5
 occupations [ɔk'yəpə'shənz] 84-86
 ocean liner [ō'shən'lɪ'nər] 58 27
 oceans [ō'shənz] 70
 octopus [ɔk'təpəs] 62 6
 office [ɔ'fɪs] 83
 office building [ɔ'fɪsbɪl'dɪŋ] 44 1
 officer [ɔ'fɪsər] 86 13
 Ohio [ōhɪ'ō] 73 35
 oil [ɔɪl] 38 12
 oil well [ɔɪl'wɛl'] 80 1
 ointment [ɔɪnt'mənt] 41 9
 Oklahoma [ō'kləhō'mə] 73 36
 old [ɔld] 24 14
 on [ɔn] 102 5
 on top of [ɔntɒp'əv] 102 10
 onion(s) [ʌn'yən(z)] 7 31
 open [ō'pən] 24 15, 31 3
 optician [ɔp'tɪʃ'ən] 84 9
 oral hygienist [ɔr'əlhɪjē'nɪst] 39 14
 orange [ɔr'ɪŋ] 8 8
 orangutan [ə'ræŋ'ətæn'] 69 18
 orbit [ɔr'bɪt] 74 21
 orchard [ɔr'chərd] 81 1
 orchestra [ɔr'kəstrə] 99 6

- orchestra seating [ör' kə strə sēt' ɪŋg] 99 12
orchid [ör' kɪd] 60 12
order [ör' dər] 17 5
Oregon [ör' ə gən] 73 37
organ [ör' gən] 98 29
ostrich [ös' trɪch] 64 12
otter [öt' ər] 68 10
out of [owt' əv] 103 7
outboard motor [owt' börd mō' tər] 59 12
outer space [owt' ər spās'] 74
outlet [owt' lət] 36 6
oval [ō' vəl] 79 18
oven [üv' ən] 30 32
over [ō' vər] 103 8
overalls [ō' vər ölz'] 21 30
overcoat [ō' vər kōt'] 19 20
overhead projector [ō' vər hēd prə jēk' tər] 76 27
overpass [ō' vər päs'] 53 3
owl [owl] 64 6
oyster(s) [oy' stər(z)] 11 33, 62 2
pacifier [päs' ə fɪ' ər] 33 22
pack [pæk] 13 16
package [pæk' ɪj] 12 4, 46 19
pad [päd] 83 26
paddle [päd' əl] 59 3, 94 18
pail [pāl] 90 16
paint (v) [pānt] 26 1
paint (n) [pānt] 37 31
paintbrush [pānt' brʊʃ'] 37 30
Painted Desert [pān' təd dez' ərɪ] 71 49
painter [pān' tər] 85 7
painting [pān' tɪŋg] 28 5
(pair of) scissors [pēr' əv sɪz' ərz] 101 17
pajamas [pə jōm' əz] 22 19
palm [pɒm] 4 29, 61 26
pan [pän] 37 28
pancakes [pän' kākz'] 18 5
pancreas [pang' krē əs] 5 71
panda [pän də] 69 20
panel truck [pän' əl trʊk'] 49 9
pansy [pän' zē] 60 2
panties [pän' tēz] 22 11
pants [pānts] 21 27
pantyhose [pän' tē hōz'] 22 5
papaya [pə pī' yə] 8 6
paper [pā' pər] 76 13
paper clips [pā' pər klɪps'] 83 28
paper towels [pā' pər tow' əlz] 35 23
parachute [pär' ə shoōt'] 48 6
parakeet [pär' ə kēt] 64 15
parallel lines [pär' ə ləl lɪnz'] 79 4
paramedic [pär' ə mēd' ɪk] 42 7
Parana River [pär' ə nō' rɪv' ər] 71 60
parents [pär' ənts] 2 6
park [pärk] 87
park ranger [pärk' rān' jər] 88 5
parka [pär' kə] 19 8
parking lights [pär' kɪŋg lɪts'] 51 49
parking garage [pär' kɪŋg gə rōj'] 45 19
parking meter [pär' kɪŋg mē' tər] 45 20
parrot [pär' ət] 64 16
part [pärt] 4 31
pass [päs] 96 5
passenger [päs' ɪn jər] 55 25
passenger car [päs' ɪn jər kār'] 53 15
pasture [päs' chər] 81 6
patient [pā' shənt] 39 20
patio [pät' ē ō'] 27 17
pattern [pät' ərn] 101 7
pattern piece [pät' ərn pēs'] 101 6
paw [pö] 69 29a
pay [pā] 17 7
pea(s) [pē(z)] 6 17
peach [pēch] 9 37
peacock [pē' kōk'] 64 18
peak [pēk] 89 20
peanut(s) [pē' nʊt(s)'] 9 28
pear [pēr] 8 18
pedal [pēd' əl] 39 18, 52 19
pedestrian [pə dēs' trē ən] 44 12
peel (n) [pēl] 9 20a
peel (v) [pēl] 31 5
pegboard [pēg' börd'] 36 15
pelican [pəl' ə kən] 64 24
pencil [pən' səl] 76 24
pencil eraser [pən' səl ə rā' sər] 76 21
pencil sharpener [pən' səl shär' pə nər] 76 20, 83 30
Pennsylvania [pən səl vān' yə] 73 38
penny [pən' ē] 13 27
penguin [pən' gwɪn] 64 27
people [pē' pəl] 2
pepper shaker [pēp' ər shā' kər] 29 9
pepper(s) [pēp' ər(z)] 7 22
percussion [pər kʊʃ' ən] 98
perfume [pür' fyoom] 23 27
periodicals section [pür' ē öd' ə kəlz sēk' shən] 47 15
periscope [pēr' ə skōp'] 48 8
perpendicular lines [pür' pən dɪk' yə lər lɪnz'] 79 2
Persian Gulf [pür' zhən gʊlf'] 70 28
personal computer (PC) [pür' səl nəl kʊm pyōō' tər/ pē' sē'] 100 31
personnel [pür' səl nəl'] 48
petal [pēt' əl] 60 18b
petri dish [pēt' rē dɪʃ'] 78 3
petunia [pə tōōn' yə] 60 7
pharmacist [fär' mə sɪst] 84 1
phases of the moon [fā' zəz əv dhə mōōn'] 74
pheasant [fēz' ənt] 64 19
Phillips screwdriver [fɪl' ɪps skrōō' drɪ vər] 37 25
phone [fōn] 32 26
photocopier [fō' tə kōp' ē ər] 83 24
photocopy machine [fō tə kōp' ē mə shēn'] 47 18
photographer [fə tōg' rə fər] 86 4
photography [fə tōg' rə fē] 100
piano [pē ān' ō] 98 1
piccolo [pɪk' ə lō'] 98 12
pick (v) [pɪk] 26 7
pick (n) [pɪk] 98 11a
pickup truck [pɪk' ʊp trʊk'] 49 4
pickax [pɪk' əks'] 82 13
pickle [pɪk' əl] 18 8
picnic area [pɪk' nɪk ər' ē ə] 88
picnic basket [pɪk' nɪk bās' kət] 88 13
picnic table [pɪk' nɪk tā' bəl] 88 15
piece [pēs] 12 22
pier [pɪr] 58 3
pierced earring [pɪrst' ɪr' ɪŋg] 23 16
pigeon [pɪj' ən] 64 1
pill [pɪl] 41 7
pillow [pɪl' ō] 32 16
pillowcase [pɪl' ō kās'] 32 15

- pilot [pī'lət] 56 15
 pin [pɪn] 23 8, 94 5, 101 20
 pincushion [pɪn'kooʃən] 101 3
 pine [paɪn] 60 34
 pineapple [paɪn'æp'əl] 8 4
 ping-pong [pɪŋ'pɒŋ/] 94
 ping-pong ball [pɪŋ'pɒŋ bɔ:l/] 94 19
 pinking shears [pɪŋ'kɪŋ ʃɪrz/] 101 5
 pipe [paɪp] 16 26, 35 18
 pipette [pɪ'pɛt/] 78 14
 pit [pɪt] 8 37a
 pitcher [pɪtʃ'ər] 29 4, 93 12
 pitcher's mound [pɪtʃ'ərz maʊnd/] 93 11
 pitchfork [pɪtʃ'fɔ:k/] 81 14
 pizza [pɪzə] 18 30
 plaid [plaɪd] 24 22
 plane [plaɪn] 57 18
 planets [plæn'əts] 74
 plant (v) [plɑ:nt] 26 4
 plants (n) [plɑ:nts] 60
 plate [plæt] 29 13
 plateau [plə'toʊ] 88 1
 platform [plɑ:t'fɔ:m] 54 11
 playground [plɔ:'graʊnd/] 87 15
 playpen [plɔ:'pɛn/] 33 30
 pleasure boating [plɛʒh'ər bɔ:'tɪŋ] 59
 pliers [plɪ'ərz] 36 19
 plug [plʌg] 37 43d
 plum [plʌm] 9 34
 plumber [plʌm'bər] 85 1
 plunger [plʌn'ʒər] 35 14
 Pluto [plu:'toʊ] 74 19
 pocket [pɒk'ət] 21 41
 pod [pɒd] 6 17a
 podium [pɒ'di:əm] 99 7
 poinsettia [pɔɪn'sɛt'ɛ:ʃə] 60 15
 poison ivy [pɔɪ'zənɪ'veɪ] 61 45
 poison oak [pɔɪ'zən ɔ:k/] 61 43
 poison sumac [pɔɪ'zən sʊ'mæk] 61 44
 poisonous plants [pɔɪ'zənəs plɑ:nts/] 61
 polar bear [pɒl'ər bɛr/] 69 22
 pole [pəʊl] 94 34, 95 14
 police officer [pə'li:s'ɔ:f'ə sər] 43 6
 police station [pə'li:s'stə:ʃən] 43
 polish [pɒl'ɪʃ] 38 3
 polka dot [pɒ'kə dɔ:t/] 24 19
 pond [pɒnd] 87 8
 pony [pɒ'neɪ] 67 20
 poplar [pɒp'lər] 61 30
 porch [pɔ:tʃ] 27 6
 porcupine [pɔ:kjə'paɪn/] 66 11
 pork [pɔ:k] 10 6
 pork chops [pɔ:k'tʃɒps/] 18 15
 port [pɔ:t] 58
 porter [pɔ:tər] 56 5
 porthole [pɔ:t'hɔ:l/] 58 21
 post [pɒst] 23 18
 post office [pɒst'ɔ:f'ɪs] 44 9, 46
 postal worker [pɒs'təl wɜ:kər] 46 14
 postcard [pɒst'kɑ:d/] 46 17
 postmark [pɒst'mɑ:k/] 46 9
 pot [pɒt] 30 13
 pot holder [pɒt'hɔ:l'dər] 30 34
 potato chips [pə'tə:tɔ:'tʃɪps/] 18 4
 potato(es) [pə'tə:tɔ:(z)] 7 23
 potty [pɒt'ɪ] 33 33
 pouch [paʊtʃ] 66 3c
 pouched mammals [paʊtʃt'mæm'ælz] 66
 poultry [pɒl'treɪ] 10
 pour [pɔ:ər] 31 4
 power lines [paʊ'ər laɪnz/] 80 24
 power sander [paʊ'ər sændər] 37 26
 power saw [paʊ'ər sɔʊ] 27 25
 power station [paʊ'ər stə:ʃən] 80 20
 prepositions [prep'əzɪ'shənz] 102, 103
 primates [praɪ'mæts] 69
 print [prɪnt] 24 21
 printer [prɪn'tər] 83 4
 printout [prɪnt'əʊt/] 83 8
 prints [prɪnts] 100 11
 prism [prɪz'm] 78 1
 private jet [praɪ'veɪt dʒet/] 57 3
 produce [prɒd'ʊs] 14 9
 programs [prɒ'græmz] 99 17
 projector [prɒ'ʃɛktər] 100 16
 propane gas [prɒ'pæn gæs/] 80 30
 propeller plane [prɒ'pɛl'ər plæn/] 57 7
 prosecuting attorney [prɒ'sə kyoo tɪŋ ə tɪr'nɛ] 43 17
 prune [pru:n] 9 22
 public library [pʌb'lɪk lɪ'brərɪ] 47
 public transportation [pʌb'lɪk trɑ:ns'pɔ:tətʃən] 54
 public telephone [pʌb'lɪk tɛl'ə fɒn] 44 7
 puck [pʌk] 92 17
 pump [pʌmp] 13 14, 52 21
 pumpkin [pʌmp'kɪn] 7 26
 punishment [pʌn'ɪʃmənt] 43
 pupil [pyoo'pəl] 5 48
 puppy [pʌp'ɪ] 69 27
 purse [pɜ:s] 20 23
 push [puʃ] 26 12
 putter [pʌt'ər] 94 9
 puzzle [pʌz'əl] 33 31
 pyramid [paɪ'rə mɪd/] 79 25
 quantities [kwɒn'tə'teɪz] 12
 quarter [kwɔ:r'tər] 11 18, 13 30, 79 31
 quarterback [kwɔ:r'tər bæk/] 93 32
 quill [kwɪl] 66 11a
 quilting [kwɪl'tɪŋ] 101 32
 rabbit [ræb'ɪt] 66 13
 raccoon [ræ'koo:n] 68 7
 race track [ræs'træk/] 95
 (racing) handlebars [ræ'sɪŋ hændl bɑ:z] 52 2
 rack [ræk] 47 17, 78 8
 racket [ræk'ɪt] 94 2
 racquet [ræk'ɪt] 94 29
 racquetball [ræk'ɪt bɔ:l/] 94 30
 radiator [ræ'deɪət'ər] 51 56
 radio [ræ'deɪoʊ] 50 18
 radish(es) [ræd'ɪʃ(əz)] 7 29
 radius [ræ'deɪəs] 79 14
 raft [ræft] 89 16
 rafters [ræf'tɔ:z] 82 1
 rafting [ræf'tɪŋ] 89
 rags [rægz] 35 4
 rain boots [ræn'boots/] 19 25
 raincoat [ræn'kəʊt/] 21 38
 rainy [ræn'ɪ] 25 1
 raise (one's hand) [reɪz'wʌnz hænd/] 77 1
 raisin(s) [reɪ'zən(z)] 9 24
 rake (v) [reɪk] 26 10
 rake (n) [reɪk] 27 30
 ranch [ræntʃ] 81

- ranch house [rəntʃ/haʊs/] 27
 ranching [rəntʃ/ɪŋg] 81
 rapids [rəp/ɪdz] 89 17
 rash [ræʃ] 40 1
 raspberries [ræz/bɛr/ɛz] 8 16
 rat [ræt] 66 7
 rattle [ræt/əl] 33 21
 rattlesnake [ræt/əl snæk/] 65 10
 razor [rə/zɔr] 23 20
 razor blades [rə/zɔr blædz/] 23 23
 read [rɛd] 77 4
 real estate agent [rɛl/ə stæt ə/jənt] 85 5
 rear bumper [rɪr/bʊm/pɔr] 50 42
 rearview mirror [rɪr/vyoo mɪr/ɔr] 50 7
 receipt [rɛ sɛt/] 15 20, 55 24
 receiver [rɛ sɛ/vɔr] 100 21
 receptionist [rɛ sɛp/shə nɛst] 86 17
 recliner [rɛ klɪ/nɔr] 28 16
 records [rɛk/ɔrdz] 100 23
 rectangle [rɛk/tæŋg/gəl] 79 19
 Red Sea [rɛd/sɛ/] 70 29
 redwood [rɛd/wuod/] 61 25
 (reel of) film [rɛl/əv fɪlm/] 100 17
 referee [rɛf/ə rɛ/] 93 22, 94 16
 reference section [rɛf/ə rɛns sɛk/shən] 47 21
 (reference) librarian [rɛf/ə rɛns lɪ brɛr/e ən] 47 23
 refill [rɛf/fɪl/] 35 11
 refinery [rɛ fɪ/nə rɛ] 80 12
 reflector [rɛ flɛk/tɔr] 52 25
 refreshment stand [rɛ frɛʃ/mənt stænd/] 90 2
 refrigerator [rɛ frɪj/ə rə/tɔr] 30 19
 reins [rænz] 94 22
 relationships [rɛ lə/shən ʃɪps/] 2
 remedies [rɛm/ə dɛz] 41
 remote control [rɛ mɔt/kən trɔl/] 28 17
 repair [rɛ pɛr/] 38 10
 repairperson [rɛ pɛr/pɪr/sən] 84 5
 reporter [rɛ pɔr/tɔr] 86 11
 reptiles [rɛp/tɪlz] 65
 rescue [rɛs/kyoo] 42
 restaurant [rɛs/tɔ rɔnt] 16
 retriever [rɛ trɛ/vɔr] 69 26
 return address [rɛ tɪrn/ə drɛs/] 46 8
 rhinoceros [rɪ nɔs/ə rɔs] 66 16
 Rhode Island [rɔd/ɪ/lænd] 73 39
 rice [rɪs] 60 21
 ride [rɪd] 97 13
 rider [rɪ/dɔr] 54 6
 rifle [rɪ/fəl] 48 21
 right angle [rɪt/æŋg/gəl] 79 23
 right fielder [rɪt/fɛl/dɔr] 93 3
 right guard [rɪt/gɑrd/] 93 28
 right lane [rɪt/læn/] 53 7
 right tackle [rɪt/tæk/əl] 93 29
 right triangle [rɪt/trɪ/æŋg gəl] 79 22
 rind [rɪnd] 8 8b
 ring(s) [rɪŋg(z)] 23 2, 74 16a, 94 17
 ring binder [rɪŋg/bɪn/dɔr] 76 14
 ring finger [rɪŋg/fɪŋg/gɔr] 4 27
 ring stand [rɪŋg/stænd/] 78 19
 rink [rɪŋk] 94 25
 Rio Grande River [rɛ/ə grænd/rɪv/ɔr] 71 57
 rivers [rɪv/ɔrz] 71
 road sign [rɔd/sɪn/] 53 23
 road work [rɔd/wɜrk/] 82
 roadrunner [rɔd/rʊn/ɔr] 64 32
 roast [rɔst] 10 3, 10 8
 roasting pan [rɔs/tɪŋg pæn/] 30 17
 robes [rɔbz] 43 11
 robin [rɔb/in] 64 9
 rock group [rɔk/gruop/] 99
 rocket [rɔk/ət] 75 13
 rocks [rɔks] 88 11
 rocking chair [rɔk/ɪŋg tʃɛr/] 33 16
 Rocky Mountains [rɔk/ə məʊn/tænz] 71 40
 rodents [rɔ/dənts] 66
 roll [rɔl] 12 11, 18 19
 (roll of) film [rɔl/əv fɪlm/] 100 10
 roller [rɔl/ɔr] 37 29
 rolling pin [rɔl/ɪŋg pɪn/] 30 25
 rolodex [rɔl/ə dɛks/] 83 14
 rooster [rɔo/stɔr] 64 21
 roof [rɔof] 27 4
 root [rɔot] 60 35d
 rope [rɔp] 89 23
 rose [rɔz] 60 18
 rotor [rɔtɔr] 57 2a
 rough [rʊf] 95 6
 router [rɔw/tɔr] 37 37
 row [rɔ] 47 11, 81 18
 rowboat [rɔ/bɔt/] 59 23
 Rub'al Khali Desert [rɔob/əl kɔl/ə dɛz/ɔrt] 71 52
 rubber tubing [rʊb/ɔr tuob/ɪŋg] 78 18
 rudder [rʊd/ɔr] 59 5
 rug [rʊg] 32 28
 ruler [rɔo/lɔr] 76 23
 run [rʊn] 96 6
 rung [rʊŋg] 82 9
 runner [rʊn/ɔr] 91 23, 94 31
 runway [rʊn/wə/] 57 19
 saddle [sæd/əl] 94 20
 safety glasses [sæf/tɛ glæs/ɔz] 78 12
 safety goggles [sæf/tɛ gɔg/ɔlz] 94 28
 safety pin [sæf/tɛ pɪn/] 33 11
 Sahara Desert [sə hɛr/ə dɛz/ɔrt] 71 51
 sail [sæl] 59 9
 sailboard [sæl/bɔrd/] 59 15
 sailboat [sæl/bɔt/] 59 4
 sailor [sæl/ɔr] 48 14
 salad bowl [sæl/əd bɔl/] 29 25
 salad dressing [sæl/əd drɛs/ɪŋg] 18 12
 salamander [sæl/ə mæn/dɔr] 65 14
 salesperson [sælz/pɪr/sən] 86 12
 salt shaker [sɔlt/shə/kɔr] 29 10
 sand (v) [sænd] 26 14
 sand (n) [sænd] 90 31
 sand dunes [sænd/duonz/] 90 12
 sand trap [sænd/træp/] 95 11
 sandal [sæn/dəl] 20 19
 sandbox [sænd/bɔks/] 87 13
 sandcastle [sænd/kæs/əl] 91 32
 sandpaper [sænd/pæ/pɔr] 37 27
 sandwich [sænd/wɪtʃ] 16 16
 sanitation worker [sæn/ə tæ/shən wɜr/kɔr] 49 7
 Saturn [sæt/ɔrn] 74 16
 saucepan [sɔs/pæn/] 30 8
 saucer [sɔ/sɔr] 29 21
 sausage [sɔ/sɪj] 10 7
 saw [sɔ] 36 8
 saxophone [sæks/sə fɔn/] 98 24
 scaffolding [skæf/əl dɪŋg] 82 7
 scale [skæl] 14 7, 34 32, 78 4
 scallop(s) [skæl/əp(s)] 11 35, 62 10

- scarecrow [skär/'krō/] 81 19
scarf [skärf] 19 19
scenery [sē/'nə rē] 99 2
school [skōol] 76, 77
science lab [sī/'əns lāb/] 78
scissors [siz/'ərz] 101 17
scoreboard [skör/'börd/] 93 19
scorpion [skör/'pē ən] 63 8
scouring pad [skowr/'iŋ pād/] 30 11
scrape [skrāp] 26 15
scraper [skrāp/'ər] 36 14
screen [skrēn] 27 19, 100 14
screw [skroō] 37 42
screwdriver [skroō/'drī /vər] 37 24
scrub [skrüb] 38 2
scuba tank [skōō/'bə tängk/] 91 37
sea gull [sē/'gūl/] 64 4
sea horse [sē/'hōrs/] 65 1
Sea of Japan [sē/'əv jə pān/] 70 36
Sea of Okhotsk [sē/'əv ō kötsk/]
70 35
seafood [sē/'fōod/] 10
seal [sēl] 68 12
seam [sēm] 101 10
seas [sēz] 70
seat [sēt] 52 16, 54 2
seat belt [sēt/'bēlt] 50 23
second baseman [sək/'ənd bās/'mən]
93 7
secretary [sək/'rə tēr/'ē] 83 11
section [sək/'shən] 8 8a, 79 15
security [sə kyōōr/'ə tē] 56
security guard [sə kyōōr/'ə tē gārd/]
56 9, 86 14
sedan [sə dān/] 51
seed [sēd] 8 8c
seesaw [sē/'sō/] 87 18
serve [sürv] 17 3, 96 2
service area [sür/'vəs ər/'ē ə] 53 11
sevice court [sür/'vəs kört/] 95 1
service line [sür/'vəs līn/] 95 3
set (the table) [sēt/'dhə tā/'bəl] 17 8
sewing [sō/'iŋ] 101
sewing machine [sō/'iŋ mə shēn/]
101 1
shade [shād] 33 1
shaft [shāft] 80 10
shampoo [shām pōō/] 34 8
shank [shānk] 36 43b
shark [shärk] 65 5
shaving cream [shā/'viŋ krēm/] 23 22
sheep [shēp] 67 25, 81 10
sheet [shēt] 32 19
sheet music [shēt/'myōō/'zīk] 98 2
shelf [shēlf] 14 6, 47 26
shell [shēl] 48 27, 62 1a, 65 18a,
90 40
shellfish [shēl/'fīsh/] 11
shepherd [shēp/'ərd] 69 28
shingle [shīŋg/'gəl] 82 2
ship [shīp] 58 9
shirt [shürt] 21 46
shock absorbers [shök/'əb zör/'bərz]
52 31
shoe [shōō] 21 49
shoelace [shōō/'lās/] 20 7
shoot [shōōt] 97 16
shop worker [shöp/'wür/'kər] 85 12
shopping bag [shöp/'iŋ bāg/] 20 18
shopping basket [shöp/'iŋ bās/'kət]
14 8
shopping cart [shöp/'iŋ kärt/] 15 19
short [shört] 24 1
short sleeve [shört/'slēv/] 20 21
shorts [shörts] 20 14
shortstop [shört/'stöp/] 93 5
shoulder [shōl/'dər] 4 5, 53 22
(shoulder) bag [shōl/'dər bāg/] 21 35
shovel (n) [shūv/'əl] 27 31, 82 15,
90 17
shovel (v) [shūv/'əl] 26 13
shower cap [show/'ər kăp/] 34 3
shower curtain [show/'ər kūr/'tən] 34 5
shower head [show/'ər hēd/] 34 4
shrimp [shrīmp] 11 31, 62 8
shutter [shüt/'ər] 27 8
shuttle car [shüt/'əl kār/] 80 8
side [sīd] 79 10
side mirror [sīd/'mīr/'ər] 50 2
sideburn [sīd/'bürn/] 4 33
sidewalk [sīd/'wök/] 45 25
Sierra Madre [sē ər/'ə mö/'drē] 71 42
silo [sī/'lō] 81 4
silverware [sīl/'vər wēr/] 29 22
simple animals [sīm/'pəl ən/'ə mælz] 62
singer [sīŋg/'ər] 99 24
sink [sīŋk] 34 19
sister [sīs/'tər] 3 10
sister-in-law [sīs/'tər ən lö/] 3 8
six-pack [sīks/'pāk/] 13 13
skate (n) [skāt] 94 26
skate (v) [skāt] 97 9
skein [skān] 101 24
ski [skē] 95 17
ski boot [skē/'boōt/] 95 15
ski cap [skē/'kăp/] 19 16
ski lift [skē/'līft/] 95 18
ski slope [skē/'slōp/] 95
skier [skē/'ər] 94 35
skis [skēz] 94 33
skin [skīn] 9 37b
skirt [skürt] 21 36
skunk [sküŋk] 68 8
slacks [släks] 20 4
sleeping bag [slē/'piŋ bāg/] 89 26
sleepwear [slēp/'wēr/] 22
slice (n) [slīs] 13 21
slice (v) [slīs] 31 10
slide [slīd] 78 31, 87 12
slide projector [slīd/'prə jēk/'tər]
100 13
slides [slīdz] 100 12
sling [slīŋ] 39 3
slippers [slīp/'ərz] 22 18
slug [slüg] 62 4
small [smöl] 24 7
smoke [smök] 42 15
smoke detector [smök/'də tēk/'tər]
33 15
smokestack [smök/'stāk/] 58 18,
80 22
snacks [snäks] 14 18
snail [snāl] 62 1
snake [snāk] 65 9
snap [snăp] 101 13
sneakers [snē/'kərz] 20 11
snorkel [snör/'kəl] 91 34
snow plow [snō/'plow/] 49 5
snowy [snō/'e] 25 3
soap [sōp] 34 15
soap dish [sōp/'dīsh/] 34 6
soccer [sök/'ər] 92
soccer ball [sök/'ər bōl/] 92 26
socks [söks] 22 17

- sofa [sō'fə] 28 25
soft drink [sōft'drɪŋk/] 16 11
softball [sōft'bɔl/] 92, 92 10
solar collector [sō'lər kə lɛk'tər]
80 17
solar eclipse [sō'lər ɪ klɪps/] 74 10
solar system [sō'lər sɪs'təm] 74
soldier [sɔl'jɛr] 48 16
sole [sɔl] 20 6
solid [sɔl'əd] 24 20
solid figures [sɔl'əd fɪg'yʊrz] 79
son [sʊn] 3 16
Sony Walkman [sō'nē wɔk'mən]
100 30
sore throat [sɔr'thrɔt/] 40 12
south [saʊθ] 71 72
South America [saʊθ'ə mɛr'ə kə]
70 2
South Atlantic [saʊθ'æt lən'tæk]
70 12
South Carolina [saʊθ'kær ə lɪ'nə]
73 40
South China Sea [saʊθ'chi'nə sē']
70 39
South Dakota [saʊθ'də kō'tə] 73 41
South Pacific [saʊθ pə sɪf'ək] 70 10
space probe [spās'prɔb] 75 4
space program [spās'prɔ'grəm] 75
space shuttle [spās'shʊt'əl] 75 14
space station [spās'stā'shən] 75 1
space suit [spās'sūit/] 75 6
spacecraft [spās'kræft/] 75
spaghetti [spə'gɛt'ē] 18 10
spaniel [spæn'yəl] 69 24
spare ribs [spɛr'rɪbz/] 10 10
spare tire [spɛr'tɪr/] 51 39
sparrow [spær'ɔ] 64 10
spatula [spæch'ə lə] 27 21
speaker [spē'kær] 28 21, 100 24
speed limit sign [spēd'lɪm ət sɪn']
53 8
speedometer [spə dɔm'ə tər] 50 10
spider [spɪ'dɛr] 63 16
spinach [spɪn'æch] 6 8
spinal cord [spɪ'nəl kɔrd/] 5 58
spiral notebook [spɪ'rəl nɔt'bʊk]
76 15
split [splɪt] 11 17
split end [splɪt'ɛnd/] 93 24
spoke [spōk] 52 26
sponge [spʊnj] 34 7
(sponge) mop [spʊnj'mɔp/] 35 6
(spool of) thread [spool'əv θrɛd']
101 2
spoon [spoon] 29 8
sports car [spɔrts'kær/] 53 17
sports [spɔrts] 92-97
spotlight [spɔt'lɪt/] 99 4
sprain [spræn] 40 13
spray can [sprā'kæn/] 13 24
spray starch [sprā'stærch/] 35 21
spread [sprɛd] 17 11
Spring [sprɪŋ] 26
sprinkler [sprɪŋ'klər] 27 13, 87 14
sprocket [sprɔk'ət] 52 20
square [skwɛr] 79 9
squid [skwɪd] 62 5
squirrel [skwɪr'əl] 66 10
stage [stāj] 99 5
staircase [stɛr'kās] 28 12
stake [stāk] 89 30
stamp [stæmp] 46 10
stands [stændz] 93 10
staple remover [stæp'əl rə moovər]
83 29
stapler [stæp'lər] 83 27
star [stär] 74 4
starfish [stär'fɪsh/] 62 7
starting gate [stär'tɪŋ gæt/] 95 20
station [stā'shən] 55 18
station wagon [stā'shən wæg'ən] 50
steak [stāk] 10 5, 11 29, 18 21
steam [stēm] 31 12
steamer [stēm'ər] 30 3
steering wheel [stɪr'ɪŋ wɛl'] 50 8
stem [stɛm] 8 2a, 60 1a
step [stɛp] 28 13
stepladder [stɛp'læd'ər] 35 1
stereo cassette player
[stɛr'ē ō kə sɛt plā'ər] 100 25
stereo system [stɛr'ē ō sɪs'təm] 28 20
stern [stɜrn] 58 11
stethoscope [stɛθ'ə skɔp'] 39 9
stewing meat [stoo'ɪŋ mɛt] 10 4
stick [stɪk] 12 5
stick shift [stɪk'shɪft/] 50 24
sting [stɪŋ] 63 8a
stingray [stɪŋ'rā/] 65 6
stir [stɪr] 31 1
stitch [stɪtʃ] 101 19
stitches [stɪtʃ'ɛz] 39 21
stockings [stɔk'ɪŋgz] 22 6
stomach [stʊm'ək] 5 66
stomachache [stʊm'ək æk'] 40 7
stool [stool] 78 34
stopper [stɔp'ər] 34 10, 78 10
stork [stɔrk] 64 30
stove [stɔv] 30 30
straight line [stræt'lɪn'] 79 1
(strand of) beads [strænd'əv bɛdz']
23 7
strap [stræp] 54 8
straw [strɔ] 16 10
strawberry [strɔ'bɛr'ē] 8 15
strawberry shortcake
[strɔ'bɛr'ē shɔrt'kæk] 18 26
stream [strēm] 88 6
street [strɛt] 45 31
street cleaner [strɛt'klɛ'nɛr] 49 1
street sign [strɛt'sɪn'] 44 8
streetcar [strɛt'kær/] 55 30
streetlight [strɛt'lɪt'] 45 29
stretch [strɛtʃ] 95 19
stretch bandage [strɛtʃ'bændʒ]
40 13a
stretcher [strɛtʃ'ər] 39 12
stretchie [strɛtʃ'ē] 33 19
string [strɪŋ] 46 20, 98 10a
string bean(s) [strɪŋ'bɛn(z)'] 6 15
strings [strɪŋgz] 98
striped [strɪpt] 24 17
stroller [strɔ'lər] 33 14
student [stʊd'ɛnt] 76 19
stuffed animal [stʊft'æn ə məl] 33 27
subject [sʊb'jɛkt] 47 10
submarine [sʊb'mə rɛn'] 48 7
subway [sʊb'wā'] 54
subway station [sʊb'wā stā'shən]
44 16
sugar (packet) [shūg'ər pæk'ət] 16 13
sugar bowl [shūg'ər bɔl'] 29 23
sugarcane [shūg'ər kæn'] 60 20
suitcase [sūit'kās'] 56 7
Summer [sʊm'ər] 26

- sun [sʌn] 74 7, 80 3
 sunbather [sʌn/ bɑ/ dhər] 90 19
 sundae [sʌn/ dē] 18 23
 sunflower [sʌn/ fləw/ ər] 60 19
 sunglasses [sʌn/ glɑs/ əz] 90 14
 sunny [sʌn/ ē] 25 4
 (sunnyside-up) egg
 [sʌn/ ē sɪd ʌp/ ěg/] 18 32
 sunroof [sʌn/ rʊf/] 51 44
 suntan lotion [sʌn/ tɑn lō/ shən] 91 39
 supermarket [sʊpə/ mɑr/ kət] 14
 surf [sɜrf] 97 12
 surfboard [sɜrf/ bɔrd/] 91 25
 surgery [sɜr/ jə rē] 41 2
 suspect [sʌs/ pɛkt] 43 3
 swan [swɔn] 64 28
 sweatband [swět/ bænd/] 20 12
 sweater [swět/ ər] 19 7, 19 13, 19 23
 sweatpants [swět/ pɑnts/] 20 10
 sweatshirt [swět/ shɜrt/] 20 8
 sweep [swēp] 38 7
 swimmer [swɪm/ ər] 91 28
 swing [swɪŋ] 33 24
 swings [swɪŋz] 87 16
 switch [swɪç] 37 43c
 switchboard [swɪç/ bɔrd/] 83 3
 switchboard operator
 [swɪç/ bɔrd ɔp/ ə rɑ tər] 83 1
 swordfish [sɔrd/ fɪʃ/] 65 3
 synthesizer [sɪn/ θə sɪ/ zər] 99 21
 syringe [sə rɪnj/] 39 27
 syrup [sɪr/ əp] 18 6
 T-shirt [tē/ shɜrt/] 21 29
 table [tɑ/ bəl] 29 7
 tablecloth [tɑ/ bəl kləθ/] 29 16
 tablet [tɑb/ lət] 41 6
 taco [tə/ kō] 18 24
 tadpole [tɑd/ pōl/] 65 16
 tail [tɑl] 57 10, 65 3a, 66 3a
 taillight [tɑl/ lɪt/] 50 31
 tailor [tɑ/ lər] 84 6
 take [tɑk] 17 10
 takeoff [tɑk/ ɔf/] 57
 Takla Makan Desert
 [tɔk/ lə mə kɔn/ dɛz/ ert] 71 53
 tambourine [tɑm/ bə rēn/] 98 17
 tank [tɑŋk] 48 10
 tank top [tɑŋk/ tɔp/] 20 13
 tanker [tɑŋk/ ər] 58 15
 tap [tɑp] 16 20
 tape [tɑp] 46 22
 tape measure [tɑp/ mɛzh/ ər] 36 21,
 101 15
 taxi [tɑk/ sē] 55
 taxi stand [tɑk/ sē stænd/] 55 28
 taxicab [tɑk/ sē kɑb/] 55 27
 tea [tē] 16 15
 teacher [tē/ chər] 76 4
 teakettle [tē/ kɛt/ əl] 30 28
 team sports [tēm/ spɔrts/] 92
 teapot [tē/ pɔt/] 29 19
 tear [tēr] 77 9
 teddy bear [tɛd/ ē bɛr/] 33 3
 tee [tē] 95 13
 telephone [tɛl/ ə fōn/] 83 15
 telescope [tɛl/ ə skɔp/] 74 22
 television [tɛl/ ə vɪzh/ ən] 28 18, 100 5
 teller [tɛl/ ər] 86 15
 temperature [tɛm/ pər ə chər] 25 6
 Tennessee [tɛn/ ə sē/] 73 42
 tennis [tɛn/ əs] 94
 tennis ball [tɛn/ əs bɔl/] 94 1
 tennis court [tɛn/ əs kɔrt/] 95
 tent [tɛnt] 89 24
 tentacle [tɛn/ tə kəl] 62 12a
 terminal [tɛrm/ ə nəl] 51 55, 58 29
 terminal building [tɛrm/ ə nəl bɪl/ dɪŋg]
 57 16
 termite [tɛr/ mɪt] 63 11
 terrier [tɛr/ ē ər] 69 25
 test tube [tɛst/ tʊb/] 78 9
 Texas [tɛk/ səs] 73 43
 textbook [tɛkst/ bʊk/] 76 26
 theater [thē/ ə tər] 99
 thermometer
 [thər mɔm/ ə tər] 25 5, 78 22
 thermos [thɜr/ məs] 88 14
 thigh [thɪ] 4 18, 11 19
 thimble [thɪm/ bəl] 101 21
 third (1/3) [thɜrd] 79 32
 third baseman [thɜrd/ bɑs/ mən] 93 4
 thorn [thɔrn] 60 18c
 thread [θrɛd] 37 42b, 101 2
 three-piece suit [θrē/ pɛs sʊt] 21 40
 throat [θrɔt] 5 59
 through [θrʊ] 103 1
 throw [θrō] 97 10
 thumb [θʌm] 4 24
 thumbtack [θʌm/ tɑk/] 76 25
 ticket [tɪk/ ət] 55 16, 56 4
 ticket window [tɪk/ ət wɪn/ dō] 55 19
 tie (n) [tī] 21 47
 tie (v) [tī] 77 12
 tie clip [tī/ klɪp/] 23 14
 tie pin [tī/ pɪn/] 23 13
 tiger [tī/ gər] 68 2
 tight [tɪt] 24 3
 tighten [tī/ tən] 38 4
 tight end [tɪt/ ɛnd/] 93 30
 tights [tɪts] 19 14
 tile [tɪl] 34 27
 timer [tī/ mər] 78 13
 timetable [tɪm/ tə/ bəl] 55 20
 tip [tɪp] 55 22
 tire [tɪr] 50 37, 52 28
 tissues [tɪʃ/ ōz] 32 13
 title [tɪ/ təl] 47 9
 to [tō] 103 9
 toast [tōst] 18 34
 toaster [tōs/ tər] 30 16
 toe [tō] 5 54
 toenail [tō/ nəl/] 5 56
 toilet [toy/ lət] 34 29
 toilet brush [toy/ lət brʌʃ/] 34 31
 toilet paper [toy/ lət pɑ/ pər] 34 30
 toiletries [toy/ lə trɛz] 23
 token booth [tō/ kən bōθ/] 54 13
 tollbooth [tōl/ bōθ/] 53 27
 tomato(es) [tə mɑ/ tō(z)] 6 19
 tongs [tɔŋz] 78 29
 tongue [tʌŋ] 4 41
 tongue depressor [tʌŋ/ də prɛs/ ər]
 40 12a
 toolbox [tōl/ bɔks/] 36 23
 toolshed [tōl/ shɛd/] 27 28
 tooth [tōθ] 4 42
 toothache [tōθ/ ək/] 40 9
 toothbrush [tōθ/ brʌʃ/] 34 21
 toothless mammals [tōθ/ ləs mɑm/ əlz]
 66
 toothpaste [tōθ/ pɑst/] 34 16
 tortoise [tɔr/ təs] 65 18
 tossed salad [tɔst/ səl/ əd] 18 13
 touch [tʌç] 77 2

- touring handlebars
[tōōr' ɪŋ hæn' dəl bärz] 52 12
- tow truck [tō' trük] 49 2
- toward [törd] 103 4
- towel rack [tow' əl ræk'] 34 25
- towrope [tō' rōp'] 59 11
- toy chest [toy' chɛst'] 33 29
- track [træk] 54 10, 94 32
- track and field [træk' ənd fēld'] 94
- tractor [træk' tər] 81 15
- tractor trailer [træk' tər trā' lər] 49 15
- traffic cop [träf' ək kōp'] 44 10
- traffic light [träf' ək līt'] 45 21
- trailer [trā' lər] 53 10
- train [trān] 55
- training wheels [trān' ɪŋ wēlz'] 52 1
- transcript [trän' skript] 43 15
- transfer [trāns' fər] 54 4
- transformer [trāns fər' mər] 80 25
- transmission towers
[trānz mɪsh' ən tow' ərz] 80 23
- transportation [trāns' pər tā' shən] 54
- transporter [trāns' pər tər] 49 17
- trash basket [trāsh' bäs' kət] 44 15
- trash can [trāsh' kæn'] 87 11
- travel agent [trāv' əl ā' jənt] 84 4
- traveler [trāv' ə lər] 56 3
- tray [trā] 16 33
- tray table [trā' tā' bəl] 56 22
- treatments [trēt' mənts] 41
- tree [trē] 61 35
- trees [trēz] 60
- triangle [trī' əŋg' gəl] 79 6
- tricycle [trī' sī kəl] 52 6
- trigger [trīg' ər] 48 22
- tripod [trī' pɒd] 100 9
- trim [trɪm] 26 8
- trombone [tröm bōn'] 98 23
- trough [tröf] 81 25
- trout [trout] 65 2
- trowel [trow' əl] 27 27
- truck [trük] 49, 53 25
- truck driver [trük' drī' vər] 49 16
- trumpet [trüm' pət] 98 25
- trunk [trüŋk] 51 40, 61 35b, 66 17a
- tub [tüb] 12 6
- tuba [tōō' bə] 98 27
- tube [tōōb] 13 15, 91 29
- tugboat [tüg' bōt'] 58 13
- tulip [tōō' ləp] 60 1
- turkey [tūr' kē] 10 23, 64 20
- turnip [tūr' nəp] 6 34
- turn signal lever [türn' sɪg nəl lē' vər]
50 11
- turn signal lights [türn' sɪg nəl līts']
51 50
- turnstile [türn' stīl'] 54 12
- turntable [türn' tā' bəl] 100 18
- turtle [tūr' təl] 65 12
- (turtleneck) sweater
[tūr' təl nək swē' tər] 19 13
- tusk [tusk] 66 17b
- TV antenna [tē' vē ən tēn' ə] 27 3
- tweezers [twē' zərz] 78 32
- twig [twīg] 61 33a
- (two-door) sedan [tōō' dōr sə dän'] 51
- type [tīp] 77 10
- typewriter [tīp' rī' tər] 83 10
- typing chair [tī' pɪŋg chēr'] 83 17
- typist [tī' pəst] 83 6
- U.S. mailbox [yōō' əs māl' bōks] 46 6
- U.S. Postal System
[yōō' əs pōs' təl sīs təm] 46
- ukulele [yōō' kə lā' lē] 98 3
- umbrella [üm brēl' ə] 20 24
- umpire [üm' pīr] 92 1, 93 17
- uncle [üŋg' kəl] 3 3
- under [ün' dər] 102 8
- underpants [ün' dər pānts'] 22 3
- undershirt [ün' dər shürt'] 22 1
- underwear [ün' dər wēr'] 22
- uniform [yōō' nə fōrm'] 21 45, 92 9
- United States of America
[yōō nī' təd stāts' əv əmēr' ə kə] 72
- universe [yōō' nə vürs'] 74
- up [üp] 103 11
- upper arm [üp' ər ərm'] 4 7
- Urals [yōōr' əlz] 71 46
- uranium rods [yōō rā' nē əm rōdz']
80 15
- Uranus [yōōr' ə nəs] 74 17
- usher [üş' ər] 99 16
- Utah [yōō' tə] 73 44
- utility pole [yōō tīl' ə tē pōl'] 80 26
- utility room [yōō tīl' ə tē rōōm] 35
- (V-neck) sweater [vē' nək swēt' ər]
19 23
- vacuum [væk' yōōm] 38 14
- vacuum cleaner [væk' yōōm klē' nər]
35 16
- valve [välv] 52 27
- van [væn] 53 26
- vase [vās] 28 6
- VCR (videocassette recorder)
[vē' sē är']/
[vīd' ē ō kə sēt' rə kōr' dər] 100 4
- vegetables [vēj' tə bəlz] 6
- vehicles and equipment
[vē' ə kəlz ənd ə kwīp' mənt] 48
- vein [vān] 5 68
- vendor [vəndər] 87 3
- vent [vēnt] 50 21
- Venus [vē' nəs] 74 12
- verbs [vürbz] 17, 26, 31, 38, 77, 96
- Vermont [vür mōnt'] 73 45
- vest [vēst] 21 39
- video [vīd' ē ō] 100
- video camera [vīd' ē ō kām' ə rə]
100 1
- videocassette (tape)
[vīd' ē ō kə sēt' tāp'] 100 3
- vine [vīn] 61 42
- viola [vē ōl' ə] 98 8
- violet [vī' ə lət] 60 16
- violin [vī ə līn'] 98 7
- Virginia [vər jīn' yə] 73 46
- wise [vīs] 37 36
- visor [vīz' ər] 50 5
- volleyball [völ' ē bōl'] 92, 92 22
- waders [wā' dərz] 88 10
- waist [wāst] 4 13
- waiter [wā tər] 16 5
- waitress [wā' trəs] 16 2
- walk [wök] 77 8
- walker [wök' ər] 33 23
- wall [wöl] 28 3
- wall unit [wöl' yōō' nət] 28 19
- wall-to-wall carpeting
[wöl' tə wöl kār' pə tɪŋg] 28 15
- wallet [wöl' ət] 20 9
- walnut(s) [wöl' nət(s)] 8 29
- walrus [wöl' rūs] 68 11
- warm [wörm] 25 8

- wash [wɔʃ] 38 16
 washcloth [wɔʃ/klɒθ/] 34 22
 washer [wɔʃ/ər] 37 40
 washing machine
 [wɔʃ/ɪŋ məʃɪn/] 35 30
 Washington [wɔʃ/ɪŋ tən] 73 47
 wasp [wɔsp] 63 20
 wastepaper basket
 [wɔst/pə pər bɑs/kæt] 34 13
 watch [wɔtʃ] 23 10
 watchband [wɔtʃ/bænd/] 23 11
 water (n) [wɔt/ər] 42 16, 91 30
 water (v) [wɔt/ər] 26 5
 water fountain [wɔt/ər fəʊn/tən]
 87 19
 water glass [wɔt/ər glɑs/] 29 6
 waterfall [wɔt/ər fɔl] 80 11, 89 18
 water-skier [wɔt/ər skɪ/ər] 59 10
 watercress [wɔt/ər krɛs/] 6 5
 watering can [wɔt/ər ɪŋ kæn/] 27 16
 watermelon [wɔt/ər mɛl/ən] 9 26
 wave [wāv] 91 24
 weapon [wɛp/ənz] 48
 weather [wɛð/ər] 25
 weather forecaster
 [wɛð/ər fɔr/kɑst ər] 86 1
 weather satellite [wɛð/ər sət/əlɪt]
 75 3
 weaving [wɛ/vɪŋ] 101 30
 web [wɛb] 63 15
 wedding ring [wɛd/ɪŋ rɪŋ/] 23 4
 weights [wəts] 78 5
 west [wɛst] 71 74
 West Virginia [wɛst/vər jɪn/yə] 73 48
 wet [wɛt] 25 15
 wet suit [wɛt/su:t/] 91 38
 whale [wāl] 68 9
 wheat [wɛt] 60 22
 wheat farm [wɛt/fɑrm/] 81
 (wheat) field [wɛt/fɛld/] 81 16
 wheel [wɛl] 52 4
 wheelbarrow [wɛl/bɑr/ɔ] 27 32,
 82 23
 wheelchair [wɛl/tʃɪr/] 39 2
 whistle [wɪs/əl] 90 5
 whole [hɔl] 11 27, 79 29
 whole (chicken) [hɔl/tʃɪk/ən] 11 16
 width [wɪð] 79 35
 wife [waɪf] 2 4
 willow [wɪl/ɔ] 61 31
 wind [waɪnd] 80 4
 windbreaker [waɪnd/breɪkər] 19 5
 windlass [waɪnd/lɑs] 58 23
 windmill [waɪnd/mɪl/] 80 19
 window [waɪn/də] 27 7, 46 15
 window cleaner [waɪn/də klɛnər]
 35 10
 windpipe [waɪnd/paɪp/] 5 60
 windshield [waɪnd/shɛld/] 51 45
 windshield wiper [waɪnd/shɛld wɪ/pər]
 50 6
 windsurfer [waɪnd/sɜr/fər] 59 14
 windy [waɪn/dɛ] 25 13
 wine [waɪn] 16 19
 wine glass [waɪn/glɑs/] 29 5
 wing [waɪŋ] 11 22, 57 9, 63 4a,
 64 1a
 Winter [waɪn/tər] 26
 wipe [waɪp] 38 5
 wire [waɪr] 37 35
 wire mesh screen [waɪr/mɛʃ skrɛn/]
 78 6
 Wisconsin [waɪs kɔn/sən] 73 49
 witness [wɪt/nəs] 43 13
 witness stand [wɪt/nəs stænd/] 43 18
 wolf [wɔlf] 69 29
 woman [wʊm/ən] 2 1
 wood [wʊd] 36 4
 wood plane [wʊd/plæn/] 37 32
 woodpecker [wʊd/pɛk/ər] 64 17
 woods [wʊdz] 89 32
 woodwinds [wʊd/wɪndz/] 98
 wool [wʊl] 101 23
 word processor [wɜrd/prɔs/sɛs ər]
 83 7
 work gloves [wɜrk/glʊvz/] 27 26
 workbench [wɜrk/bɛntʃ/] 36 22
 workshop [wɜrk/shɔp/] 36
 world [wɜrld]
 worm [wɜrm] 62 11
 wrench [rɛntʃ] 36 10
 wrist [rɪst] 4 21
 write [raɪt] 77 7
 writer [raɪ/tər] 86 7
 Wyoming [waɪ ɔ/mɪŋ] 73 50
 X ray [ɛks/rɑ/] 39 1
 X ray screener [ɛks/rɑ skrɛnər] 56 11
 xylophone [zaɪ/lə fɔn/] 98 31
 yam [jɑm] 7 24
 Yangtze River [jɑŋg/sɛ rɪv/ər] 71 69
 yarn [jɑrn] 101 31
 Yellow Sea [jɛl/ɔ sɛ/] 70 37
 Yenisey River [jɛn/ə sɑ rɪv/ər]
 71 65
 Yukon River [jʊkɔn rɪv/ər] 71 56
 zebra [zɛbrə] 66 18
 zinnia [zɪn/ɛə] 60 13
 zip code [zɪp/kɔd/] 46 12
 zipper [zɪp/ər] 101 16
 zoo [zʊ] 87 1
 zucchini [zʊkɛ/nɛ] 7 27

Pictures convey meaning more clearly than words alone. **The New Oxford Picture Dictionary** presents over 2,400 vocabulary words, clearly depicted on 102 pages of full-color, contextualized illustrations. Vocabulary is introduced within 82 topics, which range from such basics as food, clothing, and shelter to more specific topics such as the space program, occupations, and sports. An index includes all the vocabulary words with a clear, easy-to-follow pronunciation guide. The Dictionary can be used at all levels, by all ages, to teach all language skills. With the components, it provides a complete language development program. It's an invaluable resource every student and teacher needs to have.

The New Oxford Picture Dictionary contains over 2,400 words contextually presented in 102 beautifully illustrated pages. Available in paperback or hardcover.

Bilingual Editions (Spanish, Chinese, Vietnamese, Cambodian, Japanese, Korean, Navajo, Polish, Russian) present the second language in blue alongside the English word.

Wall Charts (100) feature 18" x 22" full-color reproductions of all the Dictionary pages, with vocabulary numbered on the front and listed on the back of each chart.

Overhead Transparencies (100) feature full-color transparencies of all the Dictionary pages for use on overhead projectors.

Vocabulary Playing Cards (80 laminated) include 40 color illustrations and corresponding Dictionary vocabulary, as well as a booklet of activity suggestions.

Cassettes (four C-60) feature a reading of all the Dictionary vocabulary.

Teacher's Guide, for beginning- through advanced-level students, offers introductory, language, and culture notes, as well as activity suggestions for use of the Dictionary in the class.

Beginner's Workbook, for students with no prior knowledge of English, provides extensive page-by-page practice with the vocabulary presented in the Dictionary.

Intermediate Workbook, for low- to high-intermediate level students, reinforces Dictionary vocabulary page-by-page, through written and oral practice.

Listening and Speaking Activity Book, for beginning-level ESL adults and young adults, is a teacher's resource containing more than 96 communicative activities—with reproducible activity sheets and picture cards—each one topically related to the Dictionary. A C-60 cassette is available separately.

Oxford University Press
ISBN 0-19-434199-2



9 780194 341998

